Nordstrom® and Hypreseal®

Plug Valves

Maintenance Manual



Nordstrom Valves

List of Illustrations

	Page Number
Standard Pattern Valves	3
Hypreseat Pattern Valves	3
Multiport Pattern Valves	3
Pascal's Law	4
TYPICAL SEALANT SYSTEM —	
Standard & Hypreseat	5
TYPES OF DESIGN	6
Standard Valves — Two Bolt Cover,	
Screwed & Bolted Glands	7
Hypreseat Valves — Bolted & Screwed Bottom	8 & 9
Types of Nordstrom Sealant—	
Stick & Bulk Tube	10 & 14
Manual Application	10
Hand Gun Application	10
Nordstrom 400-D Hand Gun	10 & 13
How to Use Button Head Fitting	11
Hypregun	11
Automatic Injector	11
Nordstrom Fitting	12-14
Repacking Hypreseat Valves with Stem Packing	12
Nordstrom High Pressure Gauge	13 & 14
Button Head Coupler	14
Spanner Head Wrenches	15
Three Cover Types	16
Detail of Fixed Adjustment	17
Bottom Cover Designs of Hypreseat Valves	18
Threadless Stem Designs of Hypreseat Valves ..	19
Open Worm Gearing	24
Enclosed Worm Gearing	24
Open Spur Gearing	25
Enclosed Spur Gearing	25
Enclosed Hypreseat Simple Worm Gearing	26
Enclosed Hypreseat Compound Worm Gearing ..	27
Enclosed Bevel Worm Gearing	27

Table of contents

	Page Number
Introduction	3
BASIC CONSTRUCTION	4
Sealant System	5
Types of Designs	6
Standard	7
Hypreseat	8 & 9
SEALANT MAINTENANCE	10
I. MANUAL INJECTION	
How to Inject Sealant Manually	10
II. HAND GUN	
How to Inject Sealant with a Nordstrom	
400-D Handgun	11
III. NORDSTROM HYPREGUN	
How to Inject Sealant with a Hypregun ..	11
Stem Packing	12
Operation of 400-D Hand Gun	13
Nordstrom Sealants	14
Frequency of Sealant Injection	14
Nordstrom Fitting	14
High Pressure Gauge	14
Button Head Coupler	14
How to Identify Valves	15
Valve Assembly Sealants	15
Spanner Head Wrenches	15
VALVE ADJUSTMENT PROCEDURE	16
Standard Pattern Adjustments	16-17
Hypreseat Pattern Adjustments	18-19
Hypreseat Threadless Stem & V-Ring Packing	19
VALVE MAINTENANCE PROCEDURE	20
Wrench Operated Standard Pattern	20-21
Wrench Operated Hypreseat Pattern	22-23
Gear Operated Standard Pattern	24-25
Gear Operated Hypreseat Pattern	26-27
How to Order	28

WARNING

Numerous products described in this catalog and manufactured before January 1, 1986 were equipped with packings and/or gaskets that contained asbestos. When servicing, disassembling, or disposing of these products, avoid breathing the asbestos fibers or dust.

Nordstrom maintenance manual

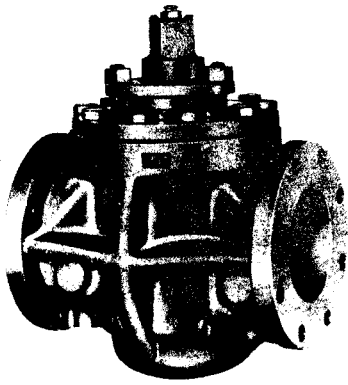

Standard

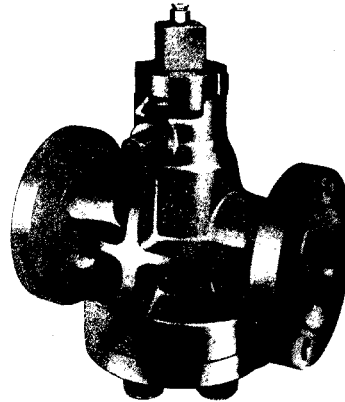

Hypreseal

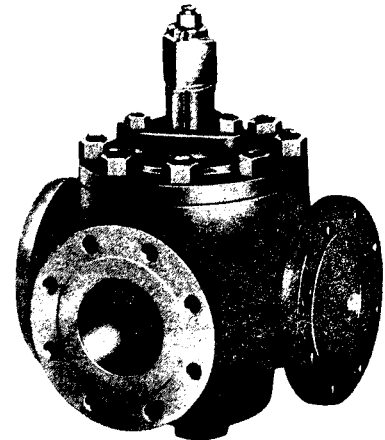

Multiport

This manual covers normal maintenance procedures only. The maintenance procedures outlined in this manual are designed to help you realize all the value built into your Nordstrom Valves—including quick and easy operation, drop-tight shutoff, and service life beyond that to be expected from any other valve on the market today.

HOW TO USE THIS MANUAL

This manual covers maintenance procedures for current Nordstrom design valves in standard patterns. It also covers Nordstrom and Hypreseal designs.

Information is grouped in four sections to be followed in an orderly step-by-step sequence to locate and correct a problem.

Basic Construction — Page 4

Sealant Maintenance — Page 10

Valve Adjustment Procedures — Page 16

Valve Maintenance Procedures — Page 20

It is suggested that you refer first to the Basic Construction section for a brief review of operating principles, sealant system, and basic design variations.

The following section, Sealant Maintenance, describes the four methods of injecting sealant and the correct procedure for each.

The third section, Valve Adjustment procedure, is to be referred to when Sealant Maintenance does not correct a problem — indicating that the valve is not adjusted properly.

The fourth section, Valve Maintenance Procedures, should be consulted only when the procedures described under Sealant Maintenance fail to restore a valve to satisfactory operating condition.

The Valve Maintenance Procedure section makes up the bulk of this manual, listing a series of “Problem-Remedy” analyses for all types of problems with all types of valves.

Unless a valve has been exposed to unusual service conditions, or damaged accidentally, the procedures outlined in this manual should, if properly followed, restore your Nordstrom valve to like-new operating condition.

Basic Construction

To consider a plan of proper maintenance and sealant lubrication, it is best to understand the principles involved in the development of the Nordstrom Valve.

The Nordstrom Valve was invented in 1915 by Sven Nordstrom and basically represents an application of Pascal's Law of Hydraulics to the dry plug cock.

The basic design of all Nordstrom Valves consists of a body, plug, cover, resilient adjustment member and sealant.

1. The function of the **body** is to connect the valve to the pipe line and mate with the plug to form a pressure vessel capable of operation under various pressures depending on the end connections and cover design.
2. The **plug** is the **only** moving part. It has a tapered surface designed to mate with the body to provide tight shut-off.
3. The **cover** retains the resilient adjustment member and prevents external leakage.
4. The **resilient adjustment member** consists of a diaphragm to allow movement without leakage, a self-energizing packing ring to maintain force against the plug and a gland to set tension against the resilient packing. The resilient adjustment member varies according to design. In the Hypreseal (with an inverted plug), it is a spring disc or bottom cover.
5. The **sealant** functions as a seal against leakage, and it also hydraulically lifts the plug from its seat in the body to provide ease of operation and to prevent sticking.

The principle is Pascal's Law of Hydraulics which states "a unit pressure applied to the fluid contained in a sealed vessel is transmitted uniformly to all areas of the confining surfaces of the fluid with undiminished force, thus multiplying the force many times, depending on the area of the interior of the vessel."

See the demonstration illustrated below.

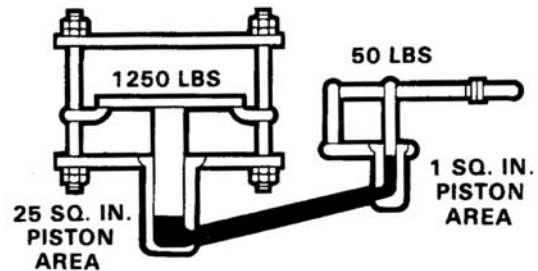

Here is a demonstration of Pascal's Law. A given pressure of 50 lb. lifts 1250 lb. over an enlarged area of 25 to 1 ratio.

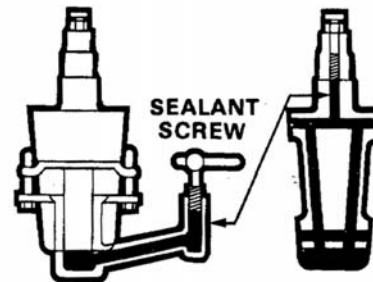

This superimposed drawing of a Nordstrom drawing of a Nordstrom plug shows application of Pascal's Law. The Sealant screw, when turned, exerts powerful hydraulic force which will slightly raise the plug from its seat if necessary.

The Nordstrom Fitting or screw, inserted in top of plug, performs the same operation, pressure being transmitted through Sealant grooves. Sealant grooves connect in plug and body, forming transmission line to bottom chamber. Plug is always sealed against line pressure.

Sealant System

Sealant as explained on page 4 functions as an actual part of the Nordstrom Valve. It is the basic improvement over the dry plug cock and to function requires a system of internal channels. These channels permit a thin film of sealant to coat the plug, insure bubble-tight shut-off, and maintain a frame of pressure around the ports. The channels connect to a reservoir in the bottom of Standard Pattern valves and at the top in Hypreseal Patterns to provide a soft replaceable seat. This soft sealant seat in the reservoir can also hydraulically lift the plug at the time of injection and maintain sealant between plug and body to prevent metal-to-metal con-

Proper valve performance depends on the following:

1. A periodic program of sealant injection to maintain enough pressure in the valve to provide positive shut-off and easy operation.
2. **Correct choice of the right Nordstrom Sealant for the service is essential. Product, temperature, line pressure and frequency of use must be considered. Since no all-purpose lubricant exists, only the right Nordstrom Sealant can assure proper valve performance.**
3. **CORRECT APPLICATION OF THE RIGHT SEALANT TO ANY NORDSTROM VALVE, OTHER THAN TO ONE THAT HAS BEEN DAMAGED,**

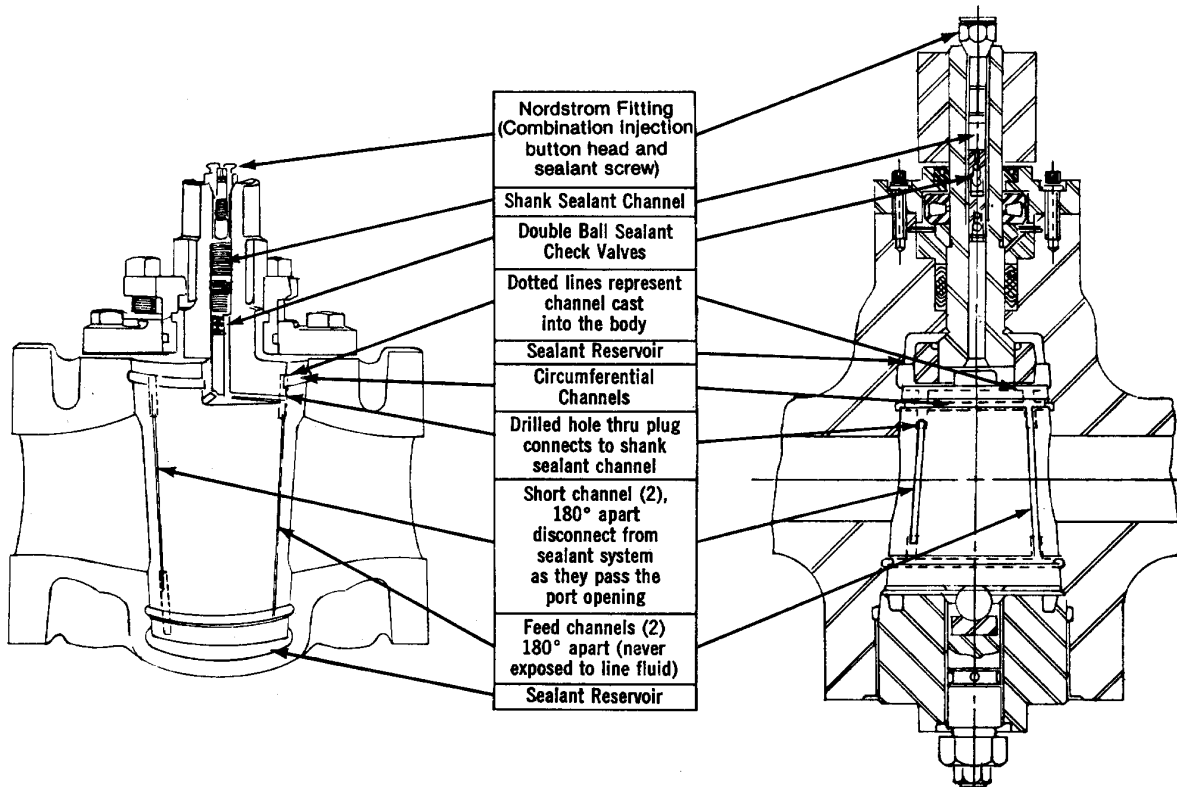

In the full open or closed position, four grooves are fed by the sealant reservoir. In other than the full open or closed position the two "feed" grooves are always connected to the reservoir.

tact of moving parts. As Nordstrom valves are turned, this unique sealant system is so constructed as to disconnect those channels that become open to the line. This prevents the sealant under pressure in the valve from equalizing with the line fluid. Other feed channels never are exposed to line fluid and in turn refill from the reservoir those exposed channels on their return. This maintains a "pressure seal" in the valve at all times around the ports when the valve is open, closed, or in a throttled position. Until the sealant is depleted, this seal will hold pressure. That is why a periodic schedule of sealant injection maintenance is recommended based on the requirements of the installation. See illustrations above.

SHOULD KEEP THE VALVE IN PROPER WORKING ORDER WITHOUT REMOVING IT FROM THE INSTALLATION.

4. **Adjustment members in all Nordstrom valves are tested for performance at the time of manufacture and should not need to be loosened or adjusted for maintenance.**

CONSIDER REMANUFACTURE OR REPAIR ONLY IF SEALANT MAINTENANCE CANNOT MAKE THE VALVE RESPOND.











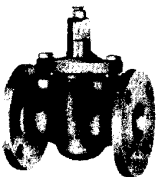

Note: **Standard Nordstrom valves turn clockwise to close.** Sealant pressure loss in a valve can occur if stops are removed or direction is changed from that set by the factory.

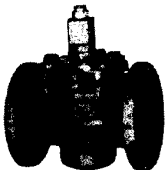
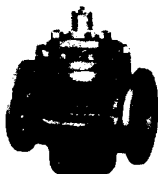
Typical Designs of Nordstrom valves

There are two basic kinds of Nordstrom valves, Standard and Hypreseal. The Standard valves are offered with combination two-bolt cover and gland; screwed; or bolted glands. The Hypreseal valves are offered with bolted or screwed bottom covers. These various types of construction are designed to offer the most complete range of cold working operating pressures (CWP) from 175 psi to 10,000 psi.

Standard and Hypreseal valves are made in regular, short, venturi and multiport patterns. Regular pattern employs a tapered form of port opening with face to

face lengths greater than those of standard gate valves. Short patterns offer the same face to face dimensions as standard flanged gate valves. The Venturi patterns, in flanged sizes 6" and larger, provide streamlined flow with reduced port sizes that reduce cost, weight and operating torque. Multiport patterns permit directional control of flow through one valve to simplify piping arrangements. Transflo versions of the multiport are also available for switching flow where it is desired that the stream never shut off completely.

PATTERNS	STANDARD	HYPRESEALS
Short	 2-Bolt Cover  Screwed Gland  Bolted Gland	 Bolted Bottom
Regular	 Screwed Gland  Bolted Gland	 Bolted Bottom  Screwed Bottom
Venturi	 Bolted Gland	 Bolted Bottom
Multiport Transflo	 Screwed Gland  Bolted Gland	 Bolted Bottom

Nordstrom Standard Valves

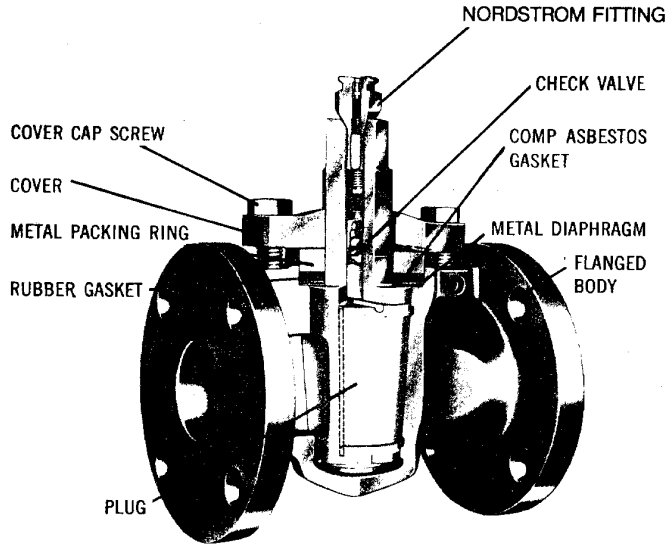

Two Bolt Cover Type

Two Bolt Cover valves are manufactured in 175 psi and 200 psi working pressure range. This type of valve is of extremely simple construction with the parts being held together by a flexible two bolt cover. The cover is bolted upon a flat packing and sealing diaphragm assembly which rests in a recess in the valve body overlying the shoulder at the top of the plug. Since the plug shoulder is slightly below the packing seat in the body, the assembly is firmly gripped around the outer edge and at the same time is displaced inward and downward against the plug to provide enough thrust to seat the plug and prevent external leakage at the shoulder. The packing assembly acts as a cushion permitting the plug to lift slightly when sealant is injected maintaining a seating force on the plug at all times.

Standard Nordstrom valve plugs turn 1/4 clockwise to close and 1/4 counter-clockwise to open.

All Nordstrom valves have one or more check valves in the system to prevent internal line pressure from coming out through the sealant system.

Screwed gland type valves and bolted gland type valves are of slightly different construction, but both employ the fundamental Nordstrom Valve basic principles. The main difference between the two types of valves is in the gland adjustment construction and the sealant channel arrangement.

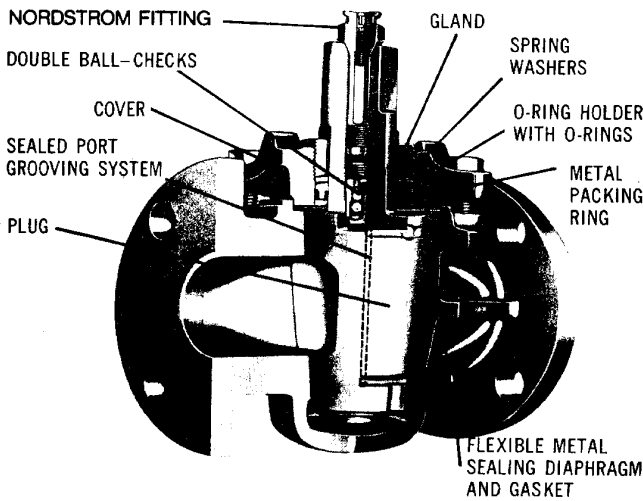

Screwed Gland Type

The screwed gland fits into a threaded cover. A flexible metal diaphragm and gasket rest in a recess in the valve body and are clamped at their outer edge between cover and body. They extend inward over the top shoulder of the plug and are held in place by the gland, which acts through spring washers and the O-ring holder. The metal diaphragm seals against the smoothly ground top surface of the plug to prevent external leakage. Two O-rings serve as a secondary seal against external leakage around the gland and the plug shank. The spring washers act as a resilient member, constantly maintaining seating force on the plug. They also permit sealant "jacking" action to unseat the plug at the time of sealant injection. This construction is used for sizes 4" and smaller and permits cold working pressure ratings from 200 psi to 1440 psi.

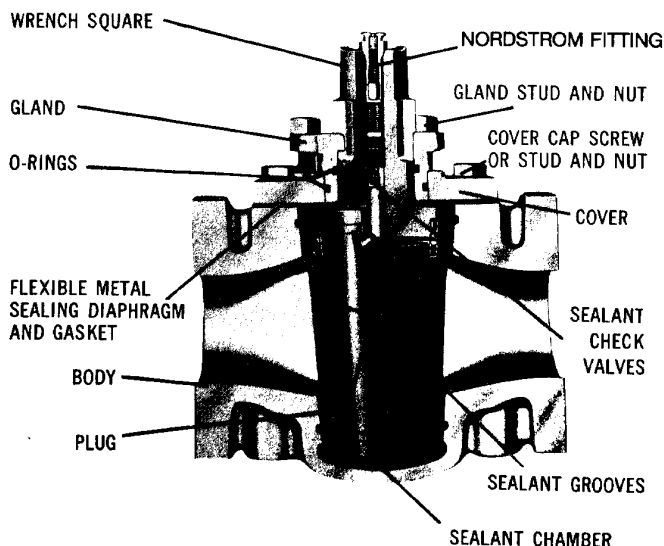

Bolted Gland Type

The bolted gland type valves differ from the screwed type only in construction of the gland. The triangular bolted gland becomes the resilient member and controls the flexing of the plug by itself rather than with the spring washers. This type of construction is used on valves 4" and larger and permits cold working pressure ratings from 200 psi to 800 psi.

**Nordstrom
Hypreseal Valve (Bolted Bottom Cover)**

The Hypreseal Valve embodies the basic Nordstrom Valve principles in an advanced design particularly suitable for high pressures, elevated temperatures, and other severe conditions. It has an inverted plug with separate rotating adjustment members located at opposite ends, each having an effective means to prevent external leakage.

There are two different types of bottom closure construction used in Hypreseal Valves. The bolted bottom cover type is used for cold working pressures up to 3600 psi. For cold working pressures above 3600 psi, a screwed bottom cover is used to provide sealing consistent with higher working pressure requirements.

Plug Stem and Equalizer Ring

The plug stem is entirely independent of the tapered plug, the two parts being coupled for rotation by a floating equalizer ring. The plug stem has a long threaded engagement in the neck of the valve body which carries the outward thrust produced by line pressure. The stem threads are lubricated and sealed by sealant from the chamber surrounding the equalizer ring. Leakage to the exterior is prevented by means of a plastic fibrous packing material which is injected into an annular groove surrounding a portion of the stem threads. Packing can be injected with valve under rated working pressure.

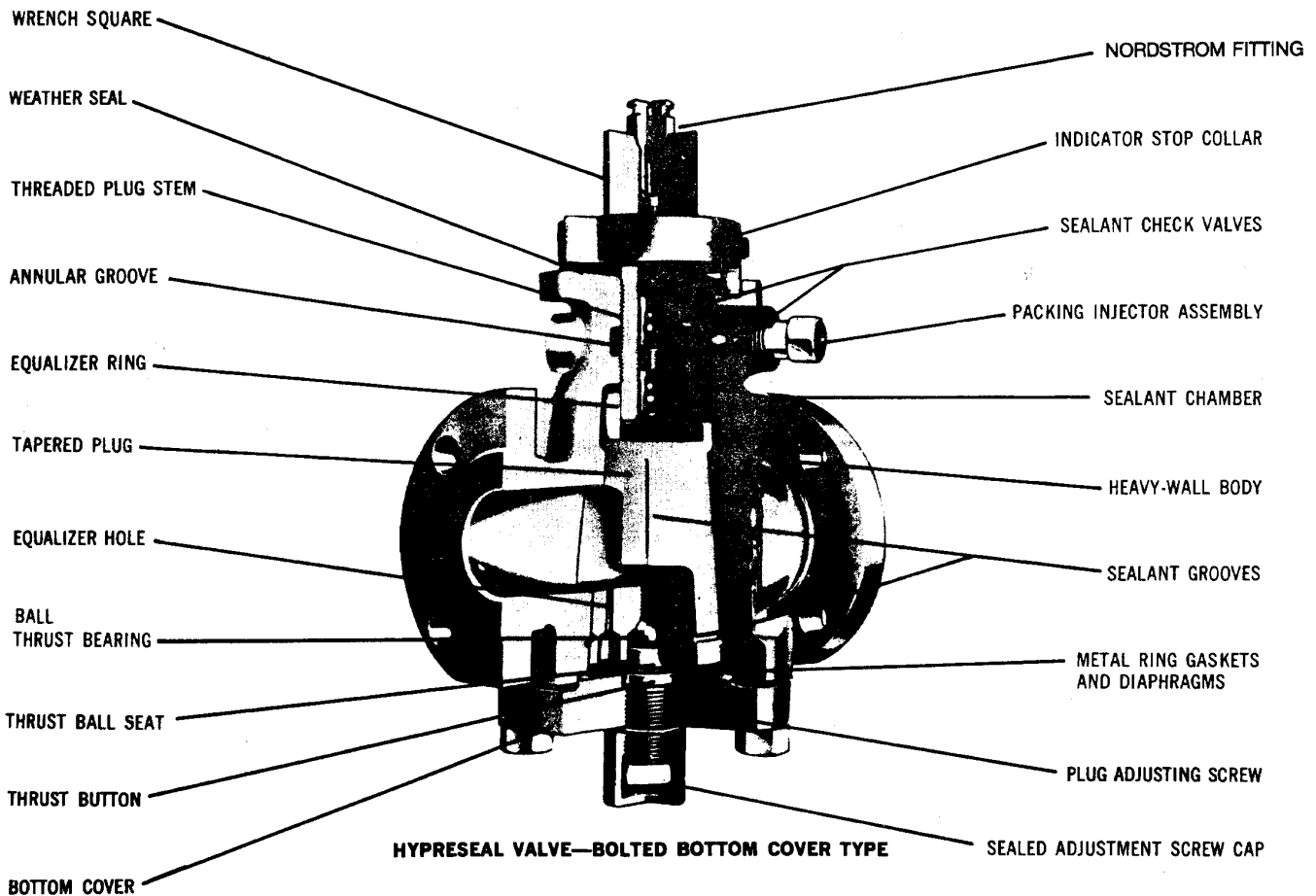

Bolted Flange Bottom Cover and Plug Seating Adjustment

The cover is bolted to the body. The plug adjustment screw is threaded through the center of the cover. It provides the thrust required to seat the plug, which is transmitted to the plug through the thrust button, flexible metal diaphragms, ball seat, and self-centering thrust ball. (Certain large size valves use slightly different thrust members.) The diaphragms and a metal ring

gasket rest in the recess in the valve body and are clamped firmly between cover and body, thus sealing the bottom closure against leakage at the cover joint and adjusting screw threads. The cover itself provides sufficient flexure to maintain proper seating thrust on the plug and permit sealant "jacking" action.

**Nordstrom
Hyreseal Valve (Screwed Bottom Cover)**

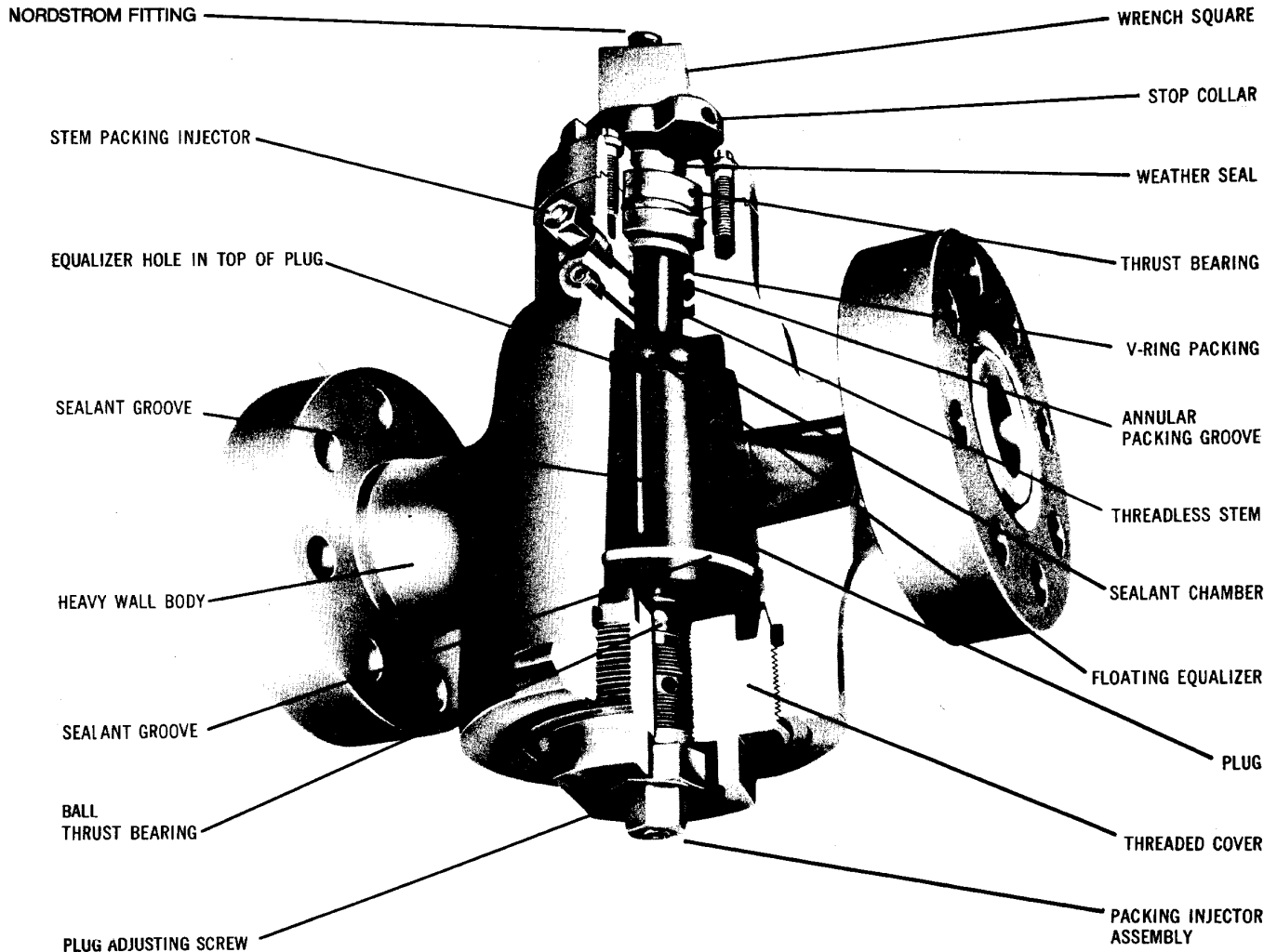

**Screwed Bottom Cover and
Plug Seating Adjustment**

The cover is attached to the body by buttress type threads to carry the outward thrust of the line pressure and functions as the resilient member. The plug adjustment screw is threaded through the center of the cover and provides the thrust required to seat the plug, which is transmitted to the plug through the ball seat, thrust ball, and spring disc. The spring disc provides the necessary flexibility in the adjustment to permit the sealant "jacking" action to function properly. A packing-sealed, threaded adjustment screw is included in the threaded bottom cover to insure proper movement of the plug and spring during sealant injection.

Threadless Plug Stem

The threadless plug stem arrangement, shown in the illustration of the valve with the screwed bottom cover, is used in the ANSI 2500 psi 2" size and larger valves and certain other high-pressure valves. In this type of assembly, the outward thrust of the plug stem is carried by a roller thrust bearing and leakage around the plug stem is prevented by means of Teflon* V-rings and fibrous plastic packing. Additional plastic packing can be injected with the valve under full rated working pressure. If necessary, the plug stem can be backseated to permit complete removal and replacement of the V-ring packings without releasing the pressure from the valve. A weather seal is provided to protect the moving parts from external moisture and corrosive atmosphere.

*T.M. of E. I. duPont de Nemours Co.

Sealant maintenance

Periodic application of sealant to Nordstrom Valves is the only recommended maintenance necessary under normal conditions. Sealant is essential to the proper operation of the valve. As the actual soft bearing seat of the valve, it requires replacement when depleted due to conditions of temperature, pressure or frequency of service.

Sealant maintenance means injecting enough sealant into a valve to provide a sealant film between tapered plug and body for free easy operation.

See page 14 for information on Sealants.



There are three ways to maintain a Nordstrom Valve: I. Manual, II. Hand Gun, III. Hypregun

I. MANUAL INJECTION. Stick sealants and tube sealants are used for manual injection. Valve dimensions pages in Nordstrom catalogs show stick sizes required. Be sure to choose the proper Nordstrom Sealant for the service considering line product, pressure and temperature—request our "Sealant and Sealant Equipment" catalog.

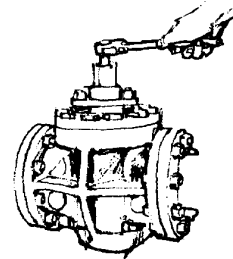
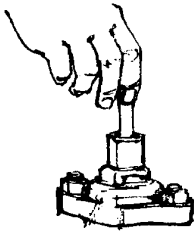

How to inject Sealant manually:

1. Remove Nordstrom fitting or lubricant screw.
2. Insert the correct size of Nordstrom Sealant stick and place it into the stem.
3. Replace the fitting and screw down with a wrench until the sealant system is filled completely. This is determined by the resistance produced by the sealant pressure. Larger valves may require several sticks or tubes of sealant due to the capacity of their sealant systems.
4. Continue to add sealant until the plug lifts (sometimes with a hissing sound) indicating the sealant system is full. When the plug lifts, effort to turn the lubricating screw will be noticeably reduced.
5. If the plug fails to respond or continues to be difficult to turn, check "Valve Maintenance Procedures", page 20.

II. HAND GUN. For installations with valves requiring frequent service, a hand operated Nordstrom 400-D High Pressure Hand Gun is recommended. This gun permits speedier servicing and also prevents waste of sealant and over filling of valves. For details, request "Sealant and Sealant Equipment" catalog.

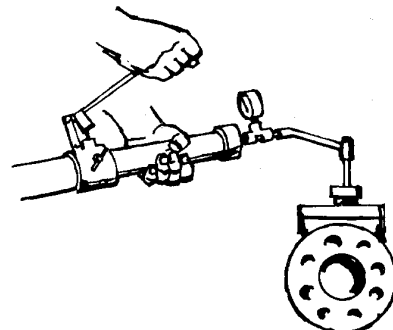

How to inject Sealant with a Nordstrom 400-D Hand Gun

See page 13 for "Operation of 400-D Hand Gun."

1. Choose the proper sealant in "J" stick size for the 400-D Hand Gun.
2. Clean accumulated dirt from the top of the fitting before engaging the coupler.
3. Fit 400-D gun's button head coupler over the Nordstrom fitting on the valve (as illustrated below).

Caution coupler should not be attached or detached while gun is under pressure.

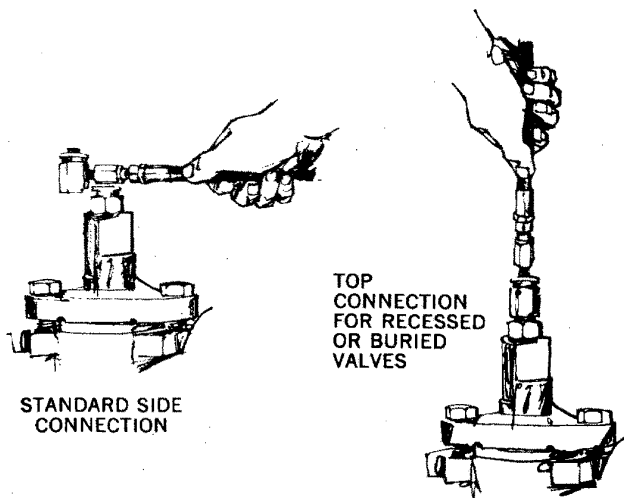

Step #1: Start coupler onto the fitting until the fitting head stops at the check valve (approx. half way).

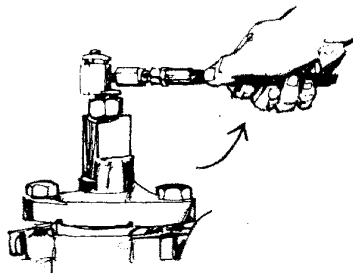

Step #2: Lift up gently on the back-end of coupler.

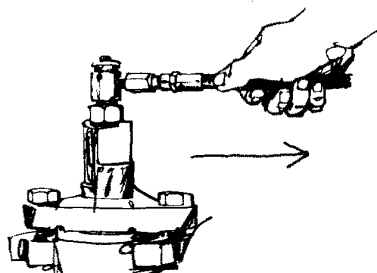

Step #3: Pull coupler onto the fitting with a gentle sliding movement. Reasonable care of sealant equipment will pay dividends in maintaining performance.

4. Inject sealant by hand pumping the 400-D gun as long as the needle on the pressure gauge climbs steadily. This should be continued as long as the valve will take pressure and volume. At some high pressure point on the gauge, the needle will "drop-back" when the plug un-seats indicating a fully pressurized system. This point can also be felt when the pumping effort falls off. Additional pumping will not hold the gauge needle, and injecting should be stopped at this point. The plug should then be turned to check the ease of operation. Additional sealant can then be injected to purge the line product or eliminate air in the system if necessary.
5. If the valve will not hold internal pressure and the needle on the gun's gauge falls to line pressure after each stroke, check Valve Maintenance Procedures, page 20.

III. NORDSTROM HYPREGUN

Where a large number of valves are in service, the Nordstrom Hypregun is recommended. It is filled by using bulk 5 quart sealant cans which are loaded directly into the Hypregun. It is self-priming, air operated and is designed to meet extensive field maintenance requirements. For information request "Sealant and Sealant Equipment" catalog.

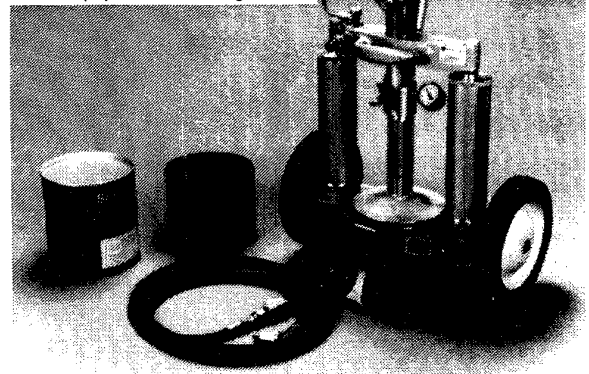

How to inject sealant with a Hypregun:

1. Choose the proper sealant in a 5 quart can and load it into the Hypregun.
2. Attach the button head coupler as illustrated by (2) Hand Gun (left).
3. Note the same procedure as Step 3 under hand gun.

Nordstrom Fitting



The one piece fitting in Nordstrom Valves can also be used to maintain sealant pressure between mechanical injection periods if used as a sealant screw. After the valve is properly lubricated, remove the lubricant screw, insert another stick of sealant and screw the fitting down until the fitting threads are totally engaged in the stem. The fitting will then extend one or two inches, providing that much more sealant capacity in the stem. The additional sealant capacity can be used as an auxiliary reservoir for further lubrication. The valve can then be pressurized by screwing in the fitting as a sealant screw as explained under "Manual Injection." When the fitting is finally turned into the valve as far as it will go, it indicates additional sealant should be added.

IMPORTANT: EXTREME CAUTION SHOULD BE TAKEN TO PREVENT ANY FOREIGN MATTER FROM ENTERING THE NORDSTROM VALVES'S SEALANT SYSTEM.

STEM PACKING FOR NORDSTROM HYPRESEAL VALVES

To maintain Nordstrom Hypreseal Valves, it is sometimes necessary to add additional stem packing. It may be several years before repacking is necessary.

When ordering stem packing, order #909 stem packing.

CAUTION: Not to be used as a sealant.

How to repack Hypreseal Valves with Stem Packing:

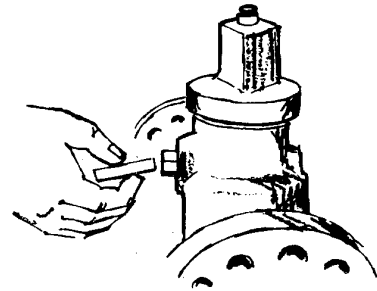

1. Remove packing injector screw. Insert a new piece of stem packing into the fitting.

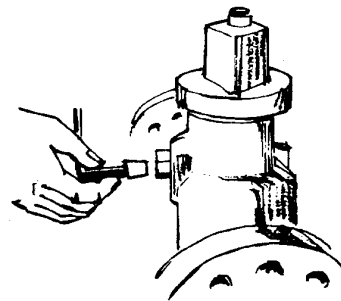

2. Replace packing injector screw.

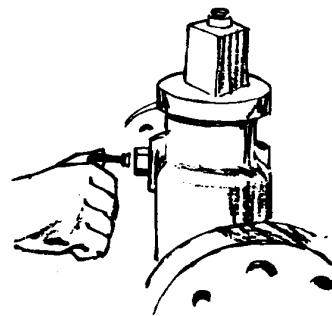

3. Tighten the packing injector screw to inject packing around the stem.

Operation of Nordstrom 400-D Hand Gun

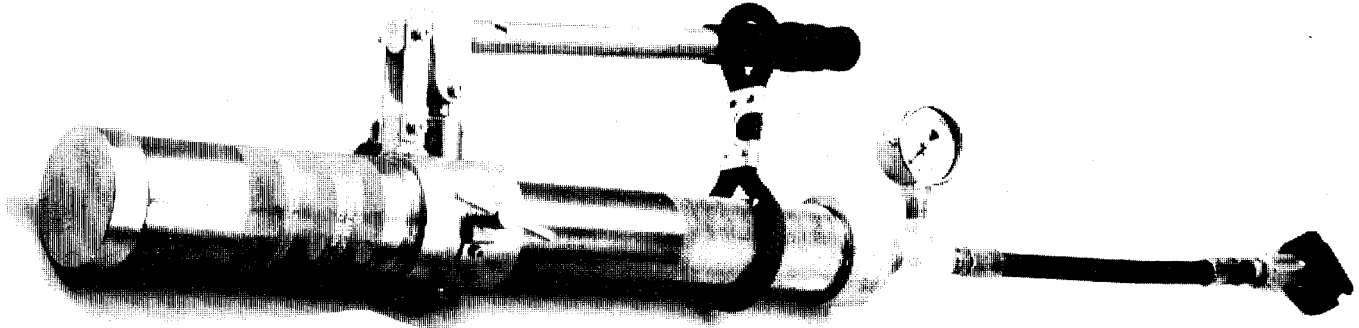

How to place a J size sealant stick in a Nordstrom 400-D Hand Gun.

1. Open the by-pass.
2. Remove the cap and hose assembly using pump handle as wrench.
3. Use the pump handle to force the piston down.
4. Place a J size stick into the barrel.
5. Replace the pump handle.
6. Close the by-pass.
7. Pump until the sealant rises $\frac{1}{8}$ " above the barrel.

Replace the cap with the hose, and tighten. If the Nordstrom 400-D Hand Gun does not build up pressure with the hose pointing upward, point the hose downward and begin pumping. If the gun pressurizes with the by-pass closed, it can be operated; however, more hydraulic fluid should be added.

Why a Pressure Gauge is Required on a Nordstrom 400-D Hand Gun.

- A. It is used to determine when the plug has lifted off its seat.
- B. By indicating pressure increases, it shows if a valve is or is not properly adjusted. Here's how to use it:
 1. Connect gun's buttonhead fitting to the valve and close the by-pass.
 2. As the gun is pumped, first the pressure rises as sealant fills the hydraulic system. Pressure varies from valve to valve approximately 2000 to 4000 psi on the gauge.

3. Second, pressure rises, and the sealant pressurizes the system, thereby jacking the plug out of the taper and spreading sealant over the plug. This is normally about 500 to 1000 psi greater than the initial pressure rise.
4. Any additional injection just forces sealant into the line.
5. After injection, valve should operate with approximately 40 - 60 lbs. pull on proper size handle or handwheel.
- C. If second pressure rise is not evident on the gauge, it indicates that the valve adjustment is loose. Remedy by readjusting the valve.
- D. If second pressure rise still is not evident after re-adjusting, there may be a score in the plug sealant grooving. This also may indicate a leak in the hydraulic system due to damage or wear.
- E. The gauge also serves as a "dwell" test to determine whether the valve is achieving a drop tight seal. See page 14 for additional information on pressure gauge.

How to determine whether the Nordstrom 400-D Hand Gun is operating correctly.

1. Nordstrom 400-D Hand Guns are built to be trouble free. They are hydraulically operated, and 90% of gun failures occur because of lack of hydraulic fluid. Be sure to recharge fluid bag periodically as shown in "Sealant and Sealant Equipment" catalog.
2. A simple indication of the lack of fluid is when the gun will not completely empty itself.
3. If pressure on the gauge remains at zero when pumping with the by-pass closed, the gun is empty. Simply refill with "J" size stick, see above.
4. Be sure to open the by-pass to relieve pressure in the hose to enable connection of the buttonhead fitting.

BE SURE PISTON IS IN RETRACTED POSITION WHEN STORING GUN TO PREVENT DAMAGE TO FLUID BAG.

NORDSTROM SEALANTS

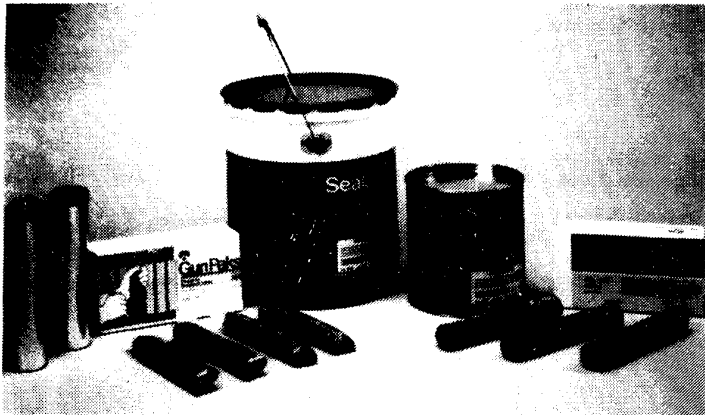

Types of Nordstrom Sealants

Nordstrom Sealants are available in:

- (1) Sticks (2) Gun Paks (3) Bulk Form

Not all sealants are made in all three forms since in some cases to do so would mean reduction of solvent-resisting or chemical-resisting properties; in other cases, satisfactory viscosity or temperature range could not be maintained. See "Sealant and Sealant Equipment" catalog.

Stick Sealants are identified by a letter denoting size, and a number indicating type. Sizes "A" to "G" are packed in boxes of 24 sticks each. The dimension tables in valve catalogs show the size of Sealant sticks required for every valve listed.

For use in high pressure booster type hand guns, most Sealants are available in "J" and "K" size sticks which are designed to fit the gun barrels. Sizes "J" and "K" Sealants are packed six sticks to the box.

Gun Paks are available for use in the 400-D Hand Gun. Sealant is always kept fresh with no chance for contamination by dirt or grit.

Bulk Sealants in five quart cans and five gallon pails are for use in bucket pumps where larger quantities of Sealants are required. Also available on special order are bulk Sealants in fifty-five gallon drums. This bulk form is regularly supplied in a soft consistency for normal use in pumping equipment. For extreme conditions, such as cold weather, where regular bulk Sealants might be too stiff for ready use, bulk Sealants are available on special order in a special soft consistency for easiest pumping.

SUGGESTED FREQUENCY OF SEALANT INJECTION

1. Service whenever opening or closing: valves on all hot services, valves handling corrosive fluids or gases, gas drips or sand drains and valves very infrequently used, such as on domestic gas distribution systems.
2. Service each four: valves on drilling-mud lines.
3. Service weekly: valves installed in refineries, gasoline plants, compressor plants and processing plants of any nature.
4. Service monthly: valves on gas, crude and products transmission lines.
5. Valves on crude, lube oil or vegetable oils require less frequent attention.

NORDSTROM FITTING

Combination Button Head Fitting Sealant Screw

The Nordstrom Fitting is standard equipment on all Rockwell Nordstrom valves. The fitting is equipped with a spring-loaded check valve and allows both manual and automatic Sealant injection without need for other special fittings. It is available separately, in several sizes, as a replacement for the lube screw on old Rockwell valves still in service.

As a replacement part, the fitting should be ordered in cold rolled steel for gray iron and steel valves; in stainless steel for non-ferrous and special metal valves.



For Valves Using Sealant Sticks — Size	Parallel Pipe Thread Size	Cold Rolled Steel Fitting Part No.	Stainless Steel Fitting Part No.
B	1/4"	37415	43012
C	3/8"	37416	43013
D	1/2"	37417	43014
G	3/4"	37418	43015

NORDSTROM HIGH PRESSURE GAUGE

For use with Sealant hand guns and pumps to provide a visual indication of the Sealant pressure being applied. Gauge needle moves up in steps until valve is completely filled. When the Sealant pressure reaches a certain point, the gauge needle begins to drop, indicating that the valve is fully serviced. Gauge also indicates need for valve adjustment. "Recalibrator" screw in face of gauge provides an easy way to correct gauge when knocked out of adjustment. The gauge has a 2" glass dial with a polished brass case and is equipped with a 1/4" NPT male connection.

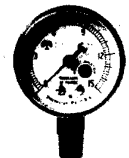

Nordstrom High Pressure Gauge

NORDSTROM Giant Button Head Coupler (with Built-in shut-off)

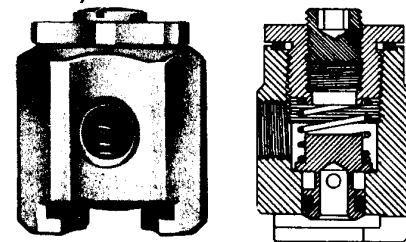

Coupler shuts off instantly on removal from fittings, preventing all further extrusion of Sealant normally caused by residual pressure in gun. Standard equipment with all Nordstrom guns. Also sold separately.

HOW TO IDENTIFY VALVES

It is necessary to identify each valve to be repaired by size, type, figure number, lot or model number to obtain proper information for parts and repair.

All valves are marked with this information at manufacture either in the casting or by name plate.

Valves in the field before 1960 were marked on their castings by lot and heat numbers and were stamped with the figure number. This information was also carried on the name plates when possible.

Valves after 1960 were marked with lot numbers and five digit date codes, the first two representing the year and the last three the day of that year.

Examples: Valves manufactured January 1, 1963 would be stamped 63001; December 31, 1963 would be stamped 63365.

All valves manufactured after 1967 will be marked with model numbers. The model number on the name plate has the manufacture date added to it. Model number only is stamped on the casting.

Examples: M5966 means Model 59 made in 1966.
M5767 means Model 57 made in 1967.
— on name plate

IMPORTANT

All inquiries regarding valves in the field should include all the identifying information available. If Figure Number, Lot or Model Numbers for some reason cannot be found, the heat numbers on the castings of steel valves or the manufacturing date will be helpful.

ADJUSTMENT OF SLOTTED GLAND VALVES WITH SPANNER HEAD WRENCHES

Adjustment of Fixed Adjustment Gland Valves with Spanner Head Wrenches

Fixed Adjustment Glands can be roughly adjusted by tightening the gland until the springs are fully compressed, and then backing off the gland about ¼ turn. Although this procedure provides just about the right amount of spring clearance for jacking the plug during sealant injection, further final adjustment is required for two reasons:

1) It is very difficult to determine the "feel" when the springs are fully compressed.

2) Variations in the mating of valve parts (and possibly in spring strength) lead to non-uniform valve torques.

Final adjustment should be made by checking the torque of the valve, **exactly as it is done with conventional glands**. It will be found that the Fixed Adjustment Gland is somewhat more sensitive in its adjustment, or in other words, a given turn of the gland will have a greater effect on the operating torque of the valve than is the case with conventional glands. Once the gland is in proper adjustment, however, it will remain so for an indefinite period of time, since the compressed springs maintain a constant seating force against the plug.

Spanner heads as shown at right facilitate gland adjustment during field installation, and you may wish to make one(s) to fit your valve(s). These spanner heads have projecting lugs on the under-side to fit into the slots in the Fixed Adjustment Gland. When the spanner head is in position, the gland may be adjusted with any standard open-end wrench.

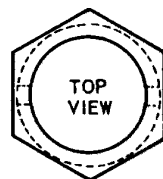

SIDE VIEWS

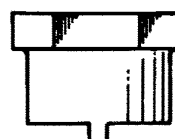
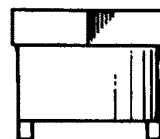

Valve adjustment procedure

BEFORE ATTEMPTING ANY READJUSTMENT OF THE VALVE, VERIFY THE FACT THAT THE VALVE IS OUT OF ADJUSTMENT BY FOLLOWING THE STEPS OUTLINED IN THE "VALVE MAINTENANCE PROCEDURE" SECTION. (Page 20)

All adjustments may be made under pressure, however, adjustment glands or plug adjusting screws cannot be removed under pressure.

This section will cover making the necessary adjustment corrections with the valve in service.

STANDARD PATTERN ADJUSTMENTS

First to be considered are the Standard Pattern adjustments. They fall into three categories, with variations, and are illustrated below:

Screwed gland fixed adjustments have a slotted gland and bolted gland fixed adjustments have a triangular shaped gland. Both are readily recognizable from the old style.

Proper performance of tapered plug valves requires correct plug adjustment: too tight a gland will result in a hard-to-turn valve; too loose a gland causes leakage. Every new valve was carefully adjusted to proper gland pressure before it left Nordstrom's plant.

Fixed adjustment gland valves are set at the plant

and should not require field attention. Braided packing (Jewett Packing) type adjustment gland valves sometimes require resetting to overcome initial "set" after prolonged periods in storage without a pressure load. Both designs may require resetting if they have been loosened in the field, along with the 2-Bolt Cover design.

The detail drawings on page 17 illustrate the current assembly: the slotted gland is set at the factory for proper compression of spring washers. Washers can flex slightly (about .001") to allow the plug to lift off its seat when pressurized sealant is injected. Standard Buna-N O-Rings seal against leakage. Special O-Rings are available for unusual conditions.

In bolted gland types, flexing of the gland for controlled plug motion is provided by the gland itself, rather than spring washers.

Both types can be adjusted, if needed, but normally require no attention for leak-free, easy-turning valve performance.

The Jewett Packing gland adjustment in Nordstrom valves should always be kept moderately snug, tight enough to keep the plug from becoming unseated and exposing the sealant film to line fluid action, but not to a degree resulting in tight contact of plug with its seat requiring excessive force to operate the valve. Do not loosen packing gland or cover. Keep glands tight.

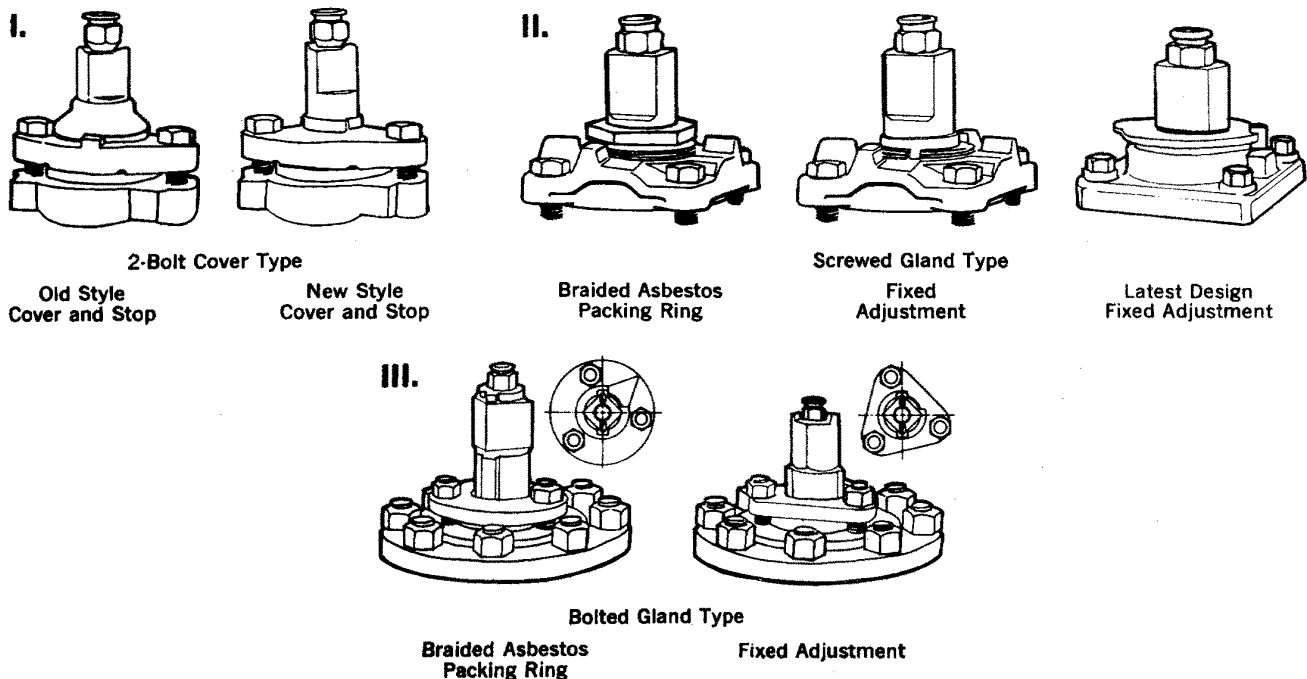

When readjusting any Nordstrom valve, do not over tighten the adjustment gland with excessive torque.

This can only result in a hard-to-operate valve. If the valve does require attention to the adjustment because it will not build or hold hydraulic pressure after checking the Valve Maintenance section, page 20, follow this procedure to readjust:

1. Turn the valve back and forth as the adjustment gland is tightened. If the valve cannot be turned the full stroke, moving it 1/2" or so will remove the excess film on the taper. From the closed position, it will require more time to reseat, however, the valve can be turned approx. 30° before the port opens. From the open position, the slightest movement begins to restrict the port opening.

A. For 2-Bolt Cover designs, tighten by alternating from side to side, keeping the cover even. Use no larger than a 10" open-end wrench. When the plug will not turn, it may appear that the cover is loose and could be tightened further without strain. **DO NOT TIGHTEN FURTHER.** This will cause pre-deflection and result in a cover leak.

B. For Bolted Gland designs, tighten the gland evenly by alternating turns on each of the three hex nuts with equal force at each nut. Make a 1/4 or 1/2 flat each turn, do not force this operation. Use the same amount of tension on the wrench at the same position for each turn. Plug should move easily as it re-seats.

C. For Screwed Gland designs, a hex wrench is used for the braided asbestos (Jewett Packing) type.

For Fixed Adjustment Type glands, special spanner head tools are listed on page 15. With them, follow the same procedure as shown above.

For valves equipped with stop adaptors, when the stop is removed during adjustment, it is very important to remember to turn the valve clockwise to close. Do not turn more than the 1/4 turn in either direction or the connecting grooves will depressurize the sealant system into the pipe. (See Sealant System, page 5).

GLANDS WITH JEWETT PACKING

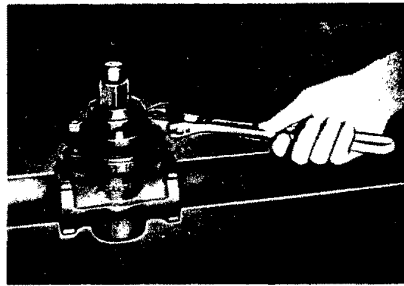

Adjustment of 2-bolt cover type. Apply even tension to two bolts.

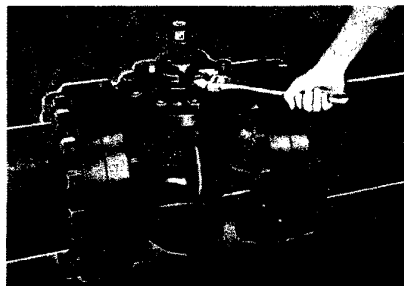

Adjustment of bolted gland type. Apply even tension to the three bolts.

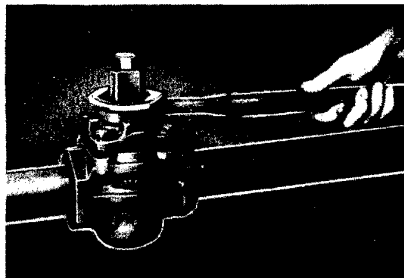

Adjustment of screwed gland type. Tighten or loosen gland.

FIXED ADJUSTMENT GLANDS

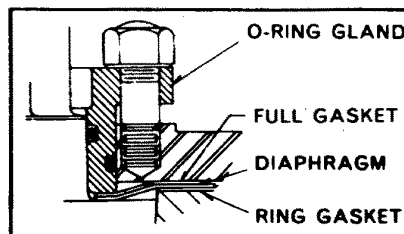

BOLTED GLAND

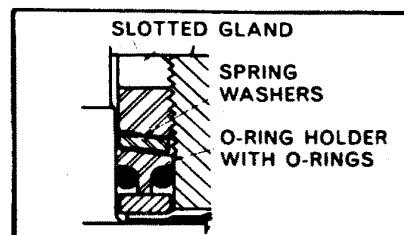

SCREWED GLAND

2. When the plug will not turn without excessive force, stop tightening the adjustment. Inject sealant and try the valve. If you are using a mechanical injector equipped with a gauge, follow the instructions given in the Sealant Maintenance Section, page 13. After freeing the plug, you should have a pressure reading above the working pressure of the valve.

A rule for setting the adjustment properly is to hold internally in the sealant system 1 1/2 to 2 times the CWP rating of the valve in valve sizes 6" or less, for 8" and larger valves use 100 to 200 psi. over the CWP rating. **This cannot be an absolute rule** because temperature, type of valve, kind of sealant, service, etc., must be considered. A cold valve, with a more viscous sealant, for example, would read much higher in pressure than the same valve with less viscous sealant at higher temperature.

THE FINAL TEST OF ANY VALVE IS HOW IT OPERATES AND PERFORMS. ALWAYS TRY THE VALVE FIRST.

A Nordstrom valve holding excessive hydraulic pressure may require the adjustment to be loosened slightly. This should be done only if the valve is difficult to operate.

If the valve cannot hold sufficient internal pressure, it may be necessary to begin the adjustment procedure again. For some reason (usually excessive sealant film or surface particles on the taper) the plug did not actually reach its seat, but merely became tight in the taper.

If there is depressurization or a stoppage in the internal sealant system, it may be necessary to follow the procedure outlined in the Valve Maintenance Section, page 20.

If sealant is injected with the valve adjustment too loose, the plug will be unseated, the sealant will be quickly dissipated, and the valve may leak. This condition may be corrected by alternately tightening the adjustment and turning the plug, thereby working out excess sealant which will permit the plug to be returned to its proper position in the body seat. **Do not slacken gland adjustment or the cover bolts if a plug becomes stuck due to lack of sealant.** Instead, tighten the adjustment and inject sealant until the plug is free. Then work out excess sealant and return the plug to its seat as described above.

Hypreseal pattern adjustments

Hypreseals have two designs, both using a plug adjusting screw, located on the bottom cover. This coarse threaded adjustment screw allows a large vertical movement with a small degree of turn. Illustrated below are both designs:

The adjustment on a Hypreseal Pattern is very critical and should not be done unless it has definitely been determined that re-adjustment is necessary. (See Valve Maintenance section, page 22.)

The Hypreseal plug adjustment, in the form of a screw at the bottom of the valve, is factory-adjusted and

Hypreseal screwed cover type, showing adjusting screw within bottom plug. A socket wrench with short extension is used. The adjustment screw carries a packing-seal fitting.

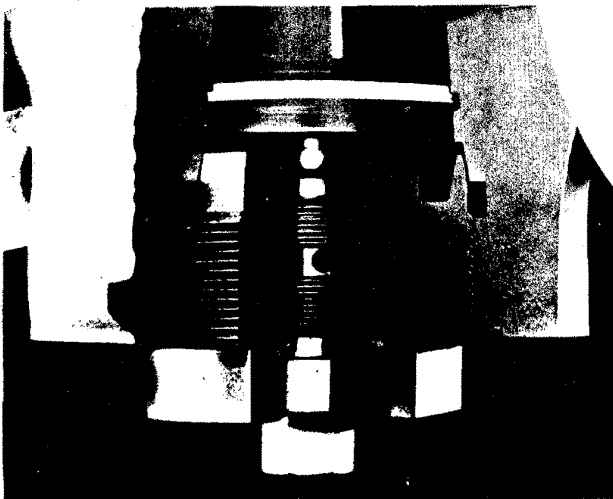
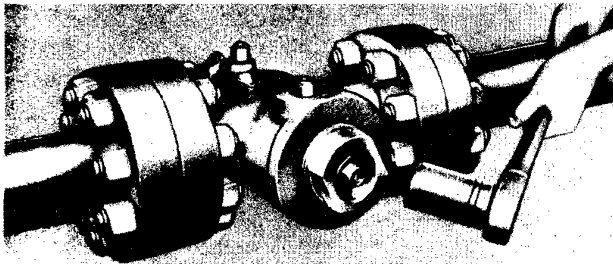

a covering seal cap is tack welded to the bolted cover. The screwed cover type plug adjustment is factory-adjusted and a packing injector in the center of the adjusting screw is used for a seal. The factory adjusted position of both adjusting screws is marked with chisel marks on the adjusting screw and cover.

The factory adjustment of Hypreseal vales is of a permanent nature, and ordinarily, does not require attention. Readjustment should be attempted only when seat leakage or hard operation persists after injection of sealant. For best results, readjustment should be made

Hypreseal bolted cover type, showing adjusting screw after seal cap is removed. This screw is factory-adjusted and seldom requires field adjustment. It can be turned with any standard open wrench of suitable size.

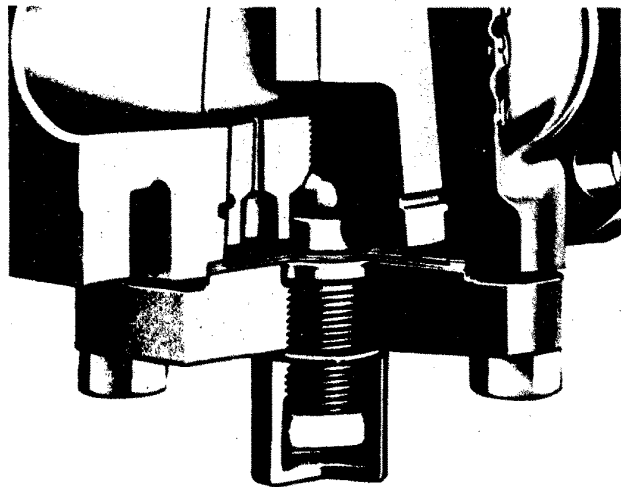
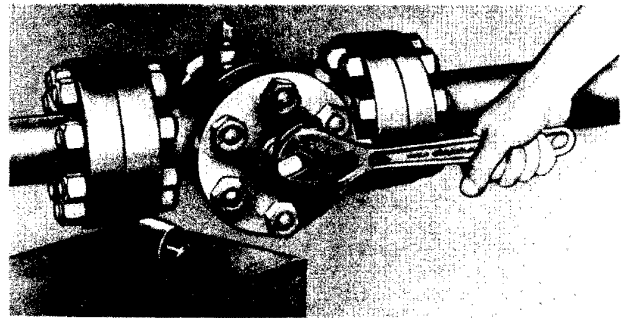

with the valve in the open position and line pressure as near zero as practical. Although the adjustment will be more difficult, satisfactory adjustment can usually be obtained with full rated pressure in the valve. When the operating temperature is over 250°F, the valve should be adjusted at operating temperature. Hard operation can be caused by either tight or loose adjustment. Plug leakage can result from loose adjustment.

The following procedure should be used when re-adjusting the plug of the Hypreseal valve:

1. Remove seal cap from bolted cover, none is required on screwed cover.
2. Observe position of match mark on adjusting screw and cover to determine whether factory adjustment has been changed.
3. If the factory adjustment appears to be changed, the screw should be tightened hard against the plug and backed off until the factory marks on the screw and cover are in line. If factory marks are not visible, the screw should be backed off $\frac{1}{8}$ turn from the hard tight position. If this adjustment appears to be unsatisfactory, slight changes should be tried.
4. If the factory adjustment appears to be unchanged, slight changes should be tried. If this is unsatisfactory, the screw should be tightened hard against the plug and then backed off $\frac{1}{8}$ turn.
5. Inject sealant and check the operating torque.
6. Much the same as a Standard Pattern, the Hypreseal Pattern plug must be "worked" into its seat by turning the valve and working out the excessive sealant or contamination on the taper until the plug seats itself. As the valve is cycled, a constant tension is maintained on the plug adjusting screw. As clearance becomes available, the plug will freely move into the taper without excessive force.
 - A. For Bolted Bottom Cover valves, this movement will be gradual and feel free.
 - B. For Screwed Bottom Cover valves, this movement will be gradual and feel free after the original torque of the plastic packing used around the plug adjusting screw is overcome.

7. When the plug is seated, the same rule applies to the Hypreseal Pattern as it does to the Standard Pattern, see page 17. Also, if there is a depressurization or a blockage in the sealant system, the same procedure must be followed. Since the plug is jacked down in the Hypreseal, it is possible to fill only part of the sealant system to unseat the plug properly and then not hold internal pressure due to solidification in the plug channels. If this occurs, see Valve Maintenance Section, page 22.

Note: The adjustment should always be made with the socket wrench on the adjusting screw hex, not the packing injector, which is the smaller hex-head fitting in the center of the adjusting screw on screwed bottom Hypreseals.

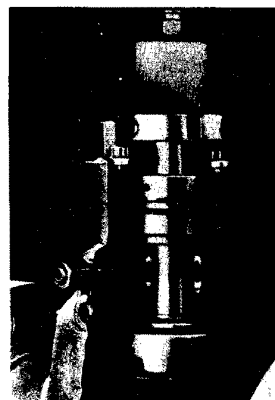

HYPRESEAL THREADLESS STEM AND V-RING PACKING

The plug stem of a threadless-stem valve is sealed against leakage by opposed sets of V-rings. The adjustment of the V-rings is by injection of plastic packing. The packing may be tightened, or additional packing sticks inserted without taking pressure off the valve or distributing the position of the plug. The packing injectors have no connection with the sealant system, and sealants should not be used in these fittings. **Use only Nordstrom stem packing in injector fittings.** Conversely, stem packing should **never** be inserted in the sealant system.

The V-ring packing can be replaced without taking pressure off the valve or removing the valve from the line. However, replacement is seldom necessary and should only be undertaken during major repairs or after injection of packing has failed to stop stem leakage. When it is necessary to replace V-rings while the valve is in service, see procedure outlined in "Repair Manual for Nordstrom and Hypreseal Valves"

Nordstrom valve maintenance procedure

This section should be considered only when sealant maintenance fails to make a valve respond.

This section has been separated into Nordstrom valve patterns for easy reference.

First, check the condition of the controls or the accessories on the valve. Many times maintenance problems are solved in this area by simple adjustments to the accessories.

WRENCH OPERATED VALVES STANDARD PATTERN

Be sure that the right wrench size is being used. Check dimension pages of Rockwell Nordstrom catalogs for the correct sizes.

- 1. Problem:** The valve plug will not turn.

Remedy: Check internal hydraulic pressure of the valve by injecting sealant. Use the gauge of a Nordstrom 400-D Hand Gun. See method page 13. Back-pressure should build-up to a release point freeing the plug. (See Sealant Maintenance page 10.)
- 2. Problem:** The valve plug will not turn after sealant is injected.

Remedy: Check the valve gland area at the stem. Rust or paint accumulation at this point may seize the stem and prevent turning the plug. Use penetrating oil to free the stem. Apply a good grade winter chassis lubricant in the gland area to keep it free.
- 3. Problem:** Sealant enters the valve but cannot build sufficient pressure to free the plug.

Remedy: Tighten the adjustment gland evenly and reinject sealant. The pressure should increase and free the plug. Refer to the Adjustment Procedures on page 16 to readjust the valve properly.
- 4. Problem:** Plug will not turn; nor will sealant pressure increase with the adjustment tightened.

Remedy: Loosen the gland, **but do not remove under line pressure**, allowing the line pressure to help unseat the plug. **Use caution as this may allow external leakage around the stem or through the Nordstrom Fitting** As soon as the plug unseats, turn it 1/4 of a turn and retighten the gland. If the valve will turn, cycle it back and forth while retightening the adjustment until the plug reseats. Reinject sealant and refer to the Adjustment Procedures on page 16 to verify adjustment.

If after tightening the gland the valve will not turn, reinject sealant immediately. If sealant pressure now builds sufficiently to unseat the plug, the plug or body may be scored at the disconnecting grooves, allowing the sealant system to depressurize. The valve is still serviceable temporarily, if it is not opened or closed the last 1/4". This leaves the grooves disconnected. **This valve should be tagged for repair.**
- 5. Problem:** Sealant pressure keeps building but the plug will not lift from its seat or turn.

Remedy: If using a gun, first check the gun connection. Check the Nordstrom Fitting to be sure the sealant is passing through. Sometimes a particle of paint is forced into the check valve in the fitting after valve re-painting. Check the stem area of the sealant passage for solidified sealant. Examine the check valve in the stem itself. Paint, dirt and grit sometimes is forced into the system and prevents the check valves from opening. Use a small diameter welding rod to push against the balls in the check valve to work them free with small amounts of penetrating oil.

CAUTION: When attempting to free the check valve in the valve stem, **STAND CLEAR** for possible blow back of sealant or product under line pressure.

- 6. Problem:** Sealant pressure keeps building but will not release the plug.
Check valves and fittings are working properly.

Remedy: The sealant system may be clogged due to sealant mixed with grit or dirt from the line. This can be verified by the fact that no matter how tight, or loose the adjustment, the plug will not seat but will become very hard to operate. The valve may have a sticky feeling as it is turned.

Loosen the gland, **but do not remove under pressure**, allowing the line pressure to help unseat the plug. **Use caution as this may allow external leakage around the stem or through the fitting.**

Using a 400-D hand gun or pump, inject kerosene or a suitable solvent directly into the sealant system. If a pump is not available, use the Rockwell Fitting as a lube screw by cleaning out the sealant in the stem and filling this void with solvent. Keep refilling and turning the fitting into the stem until the system is free. Use a small amount of service sealant on top of the solvent each time. Whether using a gun or the fitting, inject slowly to allow even distribution within the valve.

After injecting solvent proportionate to the size of valve, tighten the adjustment as the valve is cycled. While doing this continue to inject solvent. When the plug seats, re-pressurize with correct service sealant and refer to the Adjustment Procedures Section page 16 and verify the adjustment.

- 7. Problem:*** Valve closes easily but is hard to open under full line pressure differential. The valve may be leaking internally, externally or both. It requires constant or frequent sealant to stop leakage.

Remedy: Refer to Adjustment Procedures Section and verify the adjustment page 16. Plug may be shifting downstream when closed, causing a metal-to-metal bind. The sealant system equalizes with the line pressure because the plug is riding too high out of the taper or there is a score on the taper at a particular spot in the system.

- 8. Problem:*** The valve operates properly after sealant injection but must be pressurized each time to cycle. The valve also has a pressure leak around the stem.

Remedy: This usually indicates a damaged or ruptured diaphragm. This occurs when a loose adjustment allows the plug to move the diaphragm out of position and either cuts or bends it.

First, try re-adjusting the valve as detailed in the Adjustment Procedures Section page 16. If this does not correct the condition, the valve must be disassembled and repaired. Request "Repair Manual for Nordstrom and Hypreseal Valves"

- 9. Problem:*** Pressure is leaking from the valve at the sealant fitting.

Remedy: Line pressure is getting into the sealant system and equalizing pressure. Refer to the Adjustment Procedures Section, page 16, and adjust the valve properly. Also examine check valve as indicated in problem 5 page 20 if problem persists.

*Note these symptoms can also occur if wrong service sealant is used.

Wrench operated Hypreseal pattern

Hypreseal wrenches are sized for a 50 lb. pull, the same as standard valves.

1. Problem: The Hypreseal Valve plug will not turn.

Remedy: Check internal hydraulic pressure by injecting sealant either by hand or with a gun. Check with the pressure gauge on the 400-D Hand Gun, see page 13. Back-pressure should build up to a release point, unlocking the plug.

2. Problem: Sealant pressure is correct but the Hypreseal plug will not turn.

Remedy: Turn the wrench back and forth sharply while watching the indicator to check the stem for a slight movement. The stem is coupled to the plug by means of an equalizer ring. It should have a small amount of "play" through this connection. This is free movement before the stem and equalizer ring assume the load of turning the plug. If this free movement is not present, you cannot turn the stem which in turn must move the plug.

Use penetrating oil beneath the indicator stop, removing it if necessary. Clean out any accumulation of paint or rust at the stem threads.

Free the stem and keep it that way by using a good winter grade chassis lubricant.

New threaded stem valves are equipped with a rubber Weatherseal which can be supplied as a service part.

It may be necessary to build a retaining dam around the stem to let it soak in penetrating oil for a period of time. Use any type of viscous sealant that will not be affected by the oil for this job.

If rust or paint is not evident at the stem threads and the stem still has no "play", the stem may have too much packing. Remove the Allen screw from the packing injector assembly and clean out the packing as far as can be reached with available tools.

CAUTION: Do not remove the injector assembly under pressure.

Build a retaining dam around the injector opening in the same manner as above, and alternately fill the opening with penetrating oil and screw in the Allen screw. If service sealant is used, push part of the dam in to hold the oil as you turn in the screw. **DO NOT** use any ratchet operators on the Allen wrench that fits the screw, excessive internal pressure is what you are trying to eliminate.

DO NOT, UNDER ANY CIRCUMSTANCES, FORCE THE STEM. PERMANENT DAMAGE TO THE THREADS MAY NECESSITATE REMOVING THE VALVE FROM SERVICE.

3. Problem: Stem play is present and sealant enters the valve but will not increase pressure enough to cycle the plug.

Remedy: Tighten the plug adjusting screw on the bottom of the valve, and re-pressurize. When pressure increases and the plug unseats, refer to the Adjustment Procedures Section on page 16 and verify your adjustment.

- 4. Problem:** Sealant pressure keeps increasing but will not free the plug and stem. Stem "play" is present.
Remedy: See #5 under Standard Pattern, Wrench Operated Valves.
- 5. Problem:** Plug will not turn and stem "play" is present. Sealant does not release plug but pressure keeps increasing. The check valves and Nordstrom Fitting are operating properly.
Remedy: See #6 under Standard Pattern, Wrench Operated Valves. In this case adjust the plug adjusting screw located at the bottom of the valve. In addition, since the reservoir area is at the top of the plug, instead of the bottom, flush the reservoir before flushing the plug channels. Be sure the entire system is purged.
- 6. Problem:** Valve will close easily but is hard to open under line pressure. It may be leaking internally or externally. Frequent sealant injection is required to stop leakage.
Remedy: See #7 under Standard Pattern, Wrench Operated Valves. With the Hypreseal Pattern, the problem occurs because the plug is improperly adjusted.
- 7. Problem:** The Hypreseal Valve is difficult to turn in either direction. The valve pressurizes and has same stem "play."
Remedy: Refer to #2 above. This symptom is usually caused by excessive packing in the stem area or hardened packing imposing a high friction load on the stem. Follow instructions for correcting an over-packed stem.
- 8. Problem:** Hypreseal Valve leaks pressure at the stem.
Remedy: The sealant system is depressurizing through the stem threads or packing area. By using correct size Allen wrench, tighten the Allen screw at the packing injector assembly. One or two turns will usually correct this condition, if not, additional packing must be used. Use only Hypreseal Stem Packing. Turn the valve as packing is being injected to prevent over packing.
- 9. Problem:** Hypreseal Valve is leaking pressure at the bottom cover.
Remedy: For Bolted Bottom Cover designs, the metal ring gasket is usually leaking. This is a compression type gasket and if not tight enough or if damaged, the leakage will appear around the flange area of the bottom cover. Tightening the bottom cover will correct this condition if the gasket is not broken. When leakage is apparent at both the flange and the plug adjusting screw, or at just the screw, it is usually caused by a ruptured diaphragm. Replacement of the diaphragm is the only solution. This cannot be accomplished with the valve under pressure. See "Repair Manual for Nordstrom and Hypreseal Valves".
For screwed bottom cover designs, the leakage will usually be at the threaded areas. These are equipped with packing injector assemblies the same as the stem. Repack until back-pressure prevents further turning of the Allen screws.

Gear-operated standard pattern valves

Gears mechanisms and handwheel widths are designed to make Nordstrom valves "one-man" valves, with a maximum of 50 lb. of pull across the handwheel. Before deciding that a valve is **too difficult** to operate, check the appropriate Nordstrom Valve catalog for the correct diameter handwheel and review the following check points to insure proper gear operation.

Universal to all gear mechanisms is "play" through the mesh of gear teeth. If the gear teeth do not mesh properly, a bind will occur.

There are several designs of gear operators used on Standard Pattern Valves. Check the gearing below that matches your valve for maintenance information.

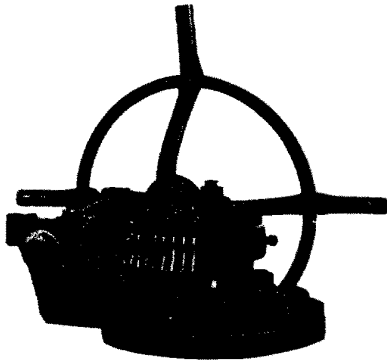

1. OPEN WORM GEARING

- A. **Check:** Wheel play. There must be free movement between the worm gear and the segment gear. This can be determined easily by turning the wheel back and forth. If free play is not present, check the bearing surfaces at the front and rear of the worm shaft. Alemite fittings are provided for servicing. A good winter grade of chassis lubricant should be injected once a year to prevent seizure at these points.
- B. **Check:** Any build-up of grease, sand, grit, or foreign material of any kind in the pitch of the gear teeth. Anything that prevents the teeth from engaging properly will bind the gears and force them apart, creating rough spots or hard to turn gears.
- C. **Check:** The height adjustment of the segment gear on the stem. The segment gear is adjusted vertically by the two set screws located 90° apart in the gear hub. The proper height adjustment allows as much play in one direction as the other. Place the worm gear as near center in the segment teeth as possible. Pry up the segment gear to raise it to the maximum height as you play the handwheel

back and forth. When the gears bind reverse the procedure, lowering the segment gear as you play the wheel. When you have located the point of maximum play, lock the segment gear in place with the two set screws.

When the gearing is performing its job properly, refer to the steps listed under Wrench Operated-Standard Pattern Valves on page 20.

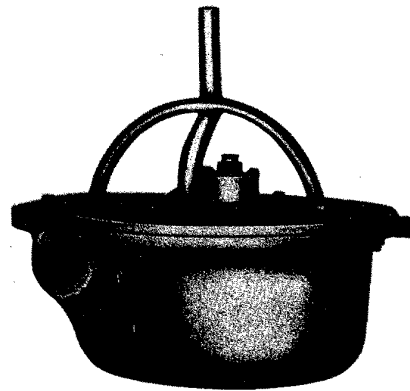

2. ENCLOSED WORM GEARING

- A. **Check:** Wheel play. Follow the instructions for the open gearing. In addition, check for any moisture in the housing which may have collected during cold weather.
- B. **Check:** Points "B" and "C" for open gearing. The housing cover can be safely removed under pressure. Use caution to protect the O-Ring seals around the cover and stem openings. **DO NOT loosen any of the cap screws or hex nuts connecting the housing to the valve, because this housing also serves as the valve cover and cannot be removed under pressure.**

When the enclosed gearing is performing its job properly, refer to the steps listed under Wrench Operated Valves, Standard Pattern, on page 20.

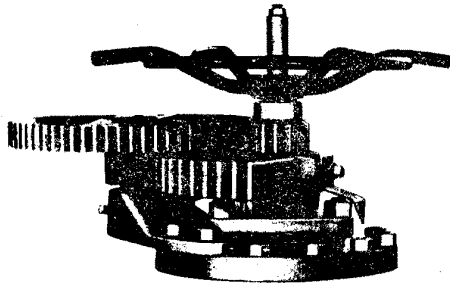

3. Open spur gearing

- A. **Check:** Wheel play. Beginning with the handwheel pinion (directly beneath the handwheel) there must be free movement throughout all the parts: handwheel, pinion, intermediate or spur gear, intermediate pinion connected to it, and the segment gear fastened to the stem.

The handwheel pinion rotates on the upper end of the plug shank. This must be a free rotation and any corrosion, rust, or dirt accumulation that impedes this movement will result in a hard to operate valve.

The intermediate or spur gear must rotate freely on the intermediate pin, or eccentric shaft. An Alemite fitting is located at the top of this shaft to provide for lubrication. Application of a good winter grade chassis lubricant once a year will prevent any seizure here. If the eccentric adjustment of this gear requires resetting to mesh the teeth properly, loosen the set screw in the spur gear bracket and rotate the pin until the proper mesh is obtained. Relock with the set screw.

The segment gear is adjusted in the same manner as detailed in "C" for worm gearing. The exception is that the height adjustment, instead of seeking maximum free play, position the gear so it will not bind on the underside of the spur gear nor on the rib casting of the bracket. Mesh the pinion and segment teeth as evenly as possible and lock the segment with the set screws.

When the spur gearing is performing its job properly, refer to the steps listed under Wrench Operated-Standard Pattern Valves on page 20.

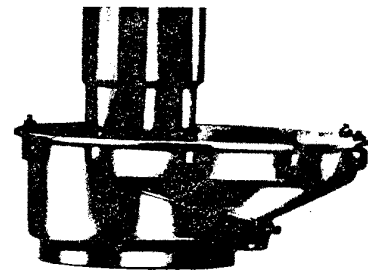

4. Enclosed spur gearing

- A. **Check:** Wheel play. Refer to "A" above for open spur gearing. Essentially, this is the same gearing except that it is enclosed in a weatherproof housing with an extension pipe and road box. Enclosed gearing is constructed for buried operation and should be moistureproof. The road box is usually at ground level and water collects in it over a period of time as does dirt and other foreign material. If the extension stem is turned without removing this accumulation, the oil and fluid seal at the top of the extension can be damaged. This permits the entrance of moisture and foreign matter into the gear housing. Water will freeze in the extension and bind the stem or fill the housing with ice.

When checking for wheel play, determine if any lack of play comes from the operating extension. In severe cold climates it may be necessary to partially fill the unit with ethylene glycol or alcohol anti-freeze until a regular fall routine of draining moisture can be established.

Draining can be accomplished by removing the vent relief fitting and inserting a plastic line or 1/4" copper tubing connected to a suction pump and pumping out any accumulation. Be sure the vent relief is free at all times.

In areas of low frost lines with high water tables, or locations where the road box is subject to severe drainage conditions, it has proven very successful to fill the entire housing and extension with an inexpensive 30W motor oil. Periodically it should then be checked to pump collected moisture from it. The oil should then be replaced to restore it to the full level.

When the enclosed spur gearing is performing properly, and the extension is free, refer to the steps listed under Wrench Operated-Standard Pattern Valves on page 20.

Gear-operated Hypreseal pattern valves

The same general statements made in the first two paragraphs for Gear-Operated-Standard Pattern Valves apply to operators for Hypreseal Patterns. There are,

however, several designs used for the Hypreseal in several gear ratios. Match the illustration below with the unit on your valve.

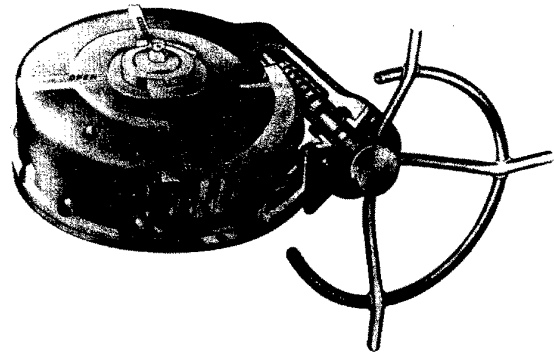
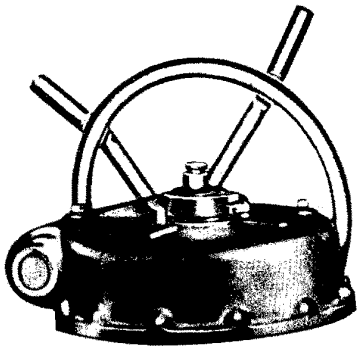

1. ENCLOSED HYPRESEAL SIMPLE WORM GEARING

A. Check: Wheel play. There must be free movement between the worm gear and the segment gear. This can be determined easily by turning the wheel back and forth. If free play is not present, check the housing for moisture collection which may have frozen. Every fall, before the cold weather arrives, remove one of the cap screws from beneath the worm and drain the moisture from the housing. Be sure the vent on top of the housing is free and not painted shut. If the valve has been turned on its side or installed vertically, interchange the vent plug with the standard pipe plug so the vent is at the highest point in the housing.

B. Check: For free movement of the indicator stop and the stem. (See Wrench Operated Hypreseal Pattern #2 on page 22). To check the play in the wheel, rotate the wheel sharply, while watching the indicator stop for a slight movement. If the stop does not move, watch the stem in the center of the stop, or place a forefinger on the stem to "feel" any movement of the stem.

If the stem tries to turn against the key, but the indicator stop does not, the problem is in the stop. If there is no stem "play," the problem is in the stem.

If the stop is frozen, pry the indicator stop out of the housing after unlocking it with the set screw or screws. If the valve must be turned before cleaning any rust or paint from the stop, use extreme caution to turn it in the correct direction to prevent disconnecting the gears or putting the connected grooves into the pipe. The keyway in the stem is parallel with the port opening in the plug. (See Sealant System on page 5.)

To work on the stem threads, it is necessary to remove the entire housing, which can be done safely while the valve is under pressure. Remove the indicator stop first, and then remove all of the housing cap screws around the bottom flange of the housing. **Mark** the position of the housing on the top flange of the valve body with a suitable punch or chisel mark, then begin turning the gearing to "walk" the housing around until the gears disconnect. **Tilt** the worm away from the center and stem and lift off.

After making the necessary corrections to the stem as detailed under Wrench Operated-Hypreseal Pattern Valves, reverse the above procedure and reinstall the housing. Insert three or four of the cap screws and check your work. When the enclosed simple worm gearing is operating satisfactorily, refer to Wrench Operated Hypreseal Pattern Valves, page 22. If gasket is replaced be sure to replace it with one of the same thickness.

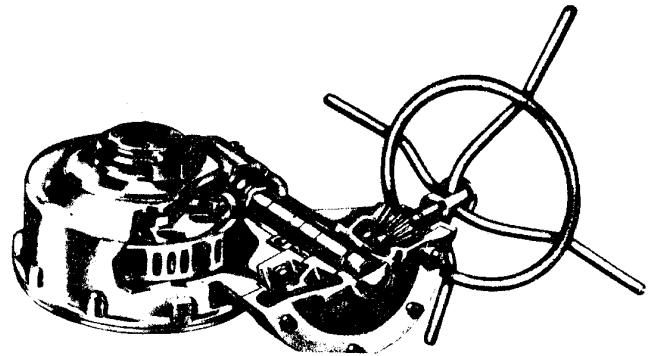
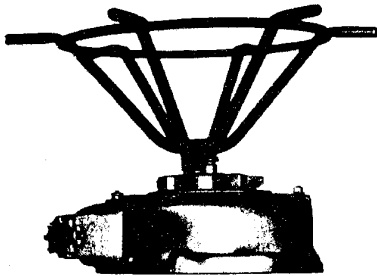

2. Enclosed Hypreaseal compound worm-gearing

- A. **Check:** Points "A" and "B" for open Worm Gearing, page 24.
- B. **Check:** For any bind between the primary and secondary worm gears. This can be determined easily by playing the wheel until it engages the teeth, then turn the wheel three or four turns. If there is a bind or audible noise, reverse the turns and come back to your starting point, checking for the same bind or noise while reversing. If the bind is in one direction only, refer to "Repair Manual for Nordstrom and Hypreaseal Valves" for instructions on resetting the secondary worm adjustment.
- C. **Check:** If, after checking "B" above, the bind is in both directions, remove the primary worm and check the thrust bearing and cap for foreign matter or rust and paint. An Alemite fitting is provided for lubrication to prevent this condition.
- D. **Check:** If the gearing has "high" spots as it is operated. This is a condition where the gearing turns easily for part of each turn and then binds at certain points each time. To remedy this, remove the primary worm and check for any distortion. Valves which have been forced will develop this kind of damage. Roll the gear on a perfectly flat surface and watch for any erratic roll. If the gear is distorted, it must be replaced.
 When the enclosed compound worm gearing is operating satisfactorily, refer to Wrench Operated Hypreaseal Pattern Valves, page 22.

3. Enclosed bevel-worm gearing

- A. **Check:** Points "A" and "B" for Open Worm Gearing, page 24.
- B. **Check:** The bevel pinion against the bevel gear. Whether the handwheel is at the side, as illustrated, or is on the top, watch for any tendency of the wheel shaft to "walk" forward towards the front of the housing as the wheel is turned to pick up the torque of the valve. Where excessive force has been used on a valve, the gears may be sprung and will not mesh properly. Disassemble the bevel gearing as detailed in "Repair Manual for Nordstrom and Hypreaseal Valves".

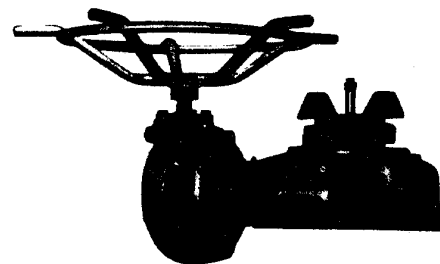

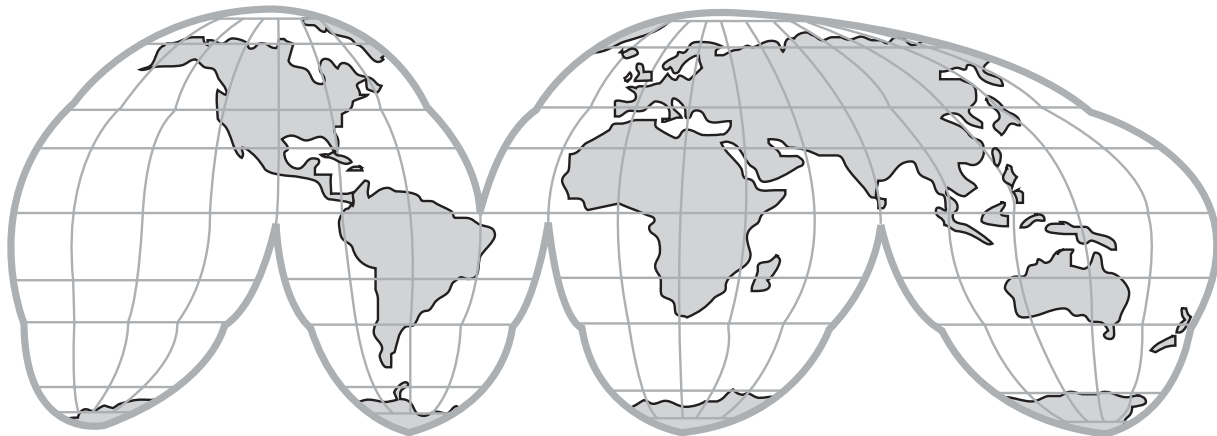

Around The World, Nordstrom Lubricated Plug Valves Have Worked For Over 70 Years –

Get The Nordstrom Edge... Value • Quality • Dependability

Authorized Distributors

For detailed information on these and other Nordstrom products, call your customer service representative for the name and number of the nearest authorized Nordstrom distributor.



Nordstrom Valves

1511 Jefferson Street
Sulphur Springs, Texas 75482
USA

1-800-225-6989

Email: nmkt@flowserve.com
or visit www.flowserve.com

United States :
Telephone: 903-885-4691 or 4693
FAX: 903-439-3411

Latin America:
Telephone: 903-439-3407
FAX: 903-439-3411

Other Countries:
Telephone: 903-885-4692
FAX: 903-439-3404

Flowserve Corporation has established industry leadership in the design and manufacture of its products. When properly selected, this Flowserve product is designed to perform its intended function safely during its useful life. However, the purchaser or user of Flowserve products should be aware that Flowserve products might be used in numerous applications under a wide variety of industrial service conditions. Although Flowserve can (and often does) provide general guidelines, it cannot provide specific data and warnings for all possible applications. The purchaser/user must therefore assume the ultimate responsibility for the proper sizing and selection, installation, operation, and maintenance of Flowserve products. The purchaser/user should read and understand the Installation and Maintenance (I&M) instructions included with the product, and train its employees and contractors in the safe use of Flowserve products in connection with the specific application.

While the information and specifications contained in this literature are believed to be accurate, they are supplied for informative purposes only and should not be considered certified or as a guarantee of satisfactory results by reliance thereon. Nothing contained herein is to be construed as a warranty or guarantee, express or implied, regarding any matter with respect to this product. Because Flowserve is continually improving and upgrading its product design, the specifications, dimensions and information contained herein are subject to change without notice. Should any question arise concerning these provisions, the purchaser/user should contact Flowserve Corporation at any one of its worldwide operations or offices.

For more information about Flowserve Corporation, contact www.flowserve.com or call USA 1-800-225-6989.