

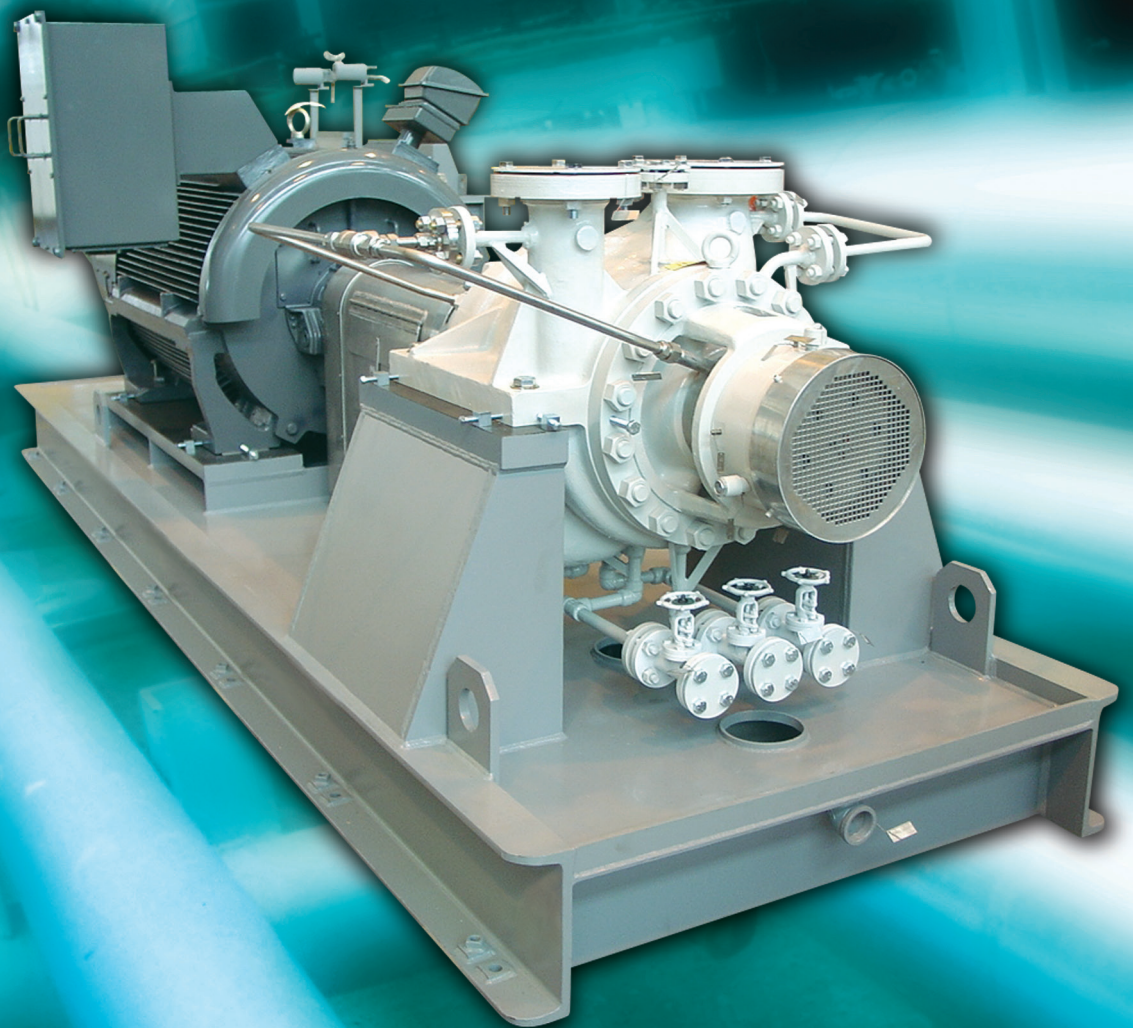

***HED and HED-DS
Between Bearings, Two-Stage,
Radially Split Pumps***

ISO 13709/API 610 (BB2)



Experience In Motion

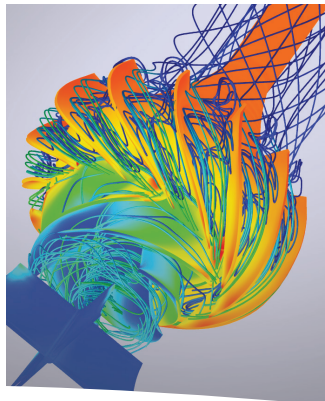
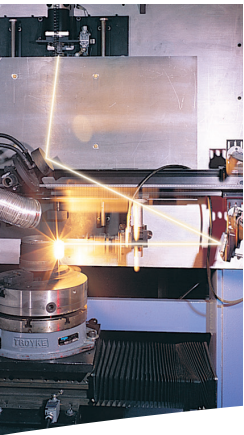

Pump Supplier to the World

Flowserve is the driving force in the global industrial pump marketplace. No other pump company in the world has the depth or breadth of expertise in the successful application of pre-engineered, engineered and special purpose pumps and systems.

Life Cycle Cost Solutions

Flowserve provides pumping solutions that permit customers to reduce total life cycle costs and improve productivity, profitability and pumping system reliability.

Market Focused Customer Support

Product and industry specialists develop effective proposals and solutions directed toward market and customer preferences. They offer technical advice and assistance throughout each stage of the product life cycle, beginning with the inquiry.

Broad Product Lines

Flowserve offers a wide range of complementary pump types, from pre-engineered process pumps, to highly engineered and special purpose pumps and systems. Pumps are built to recognized global standards and customer specifications.

Pump designs include:

- Single-stage process
- Between bearings single-stage
- Between bearings multistage
- Vertical
- Submersible motor
- Positive displacement
- Nuclear
- Specialty

Product Brands of Distinction

ACEC™ Centrifugal Pumps

Aldrich™ Pumps

Byron Jackson® Pumps

Calder™ Energy Recovery Devices

Cameron™ Pumps

Durco® Process Pumps

Flowserve® Pumps

IDP® Pumps

INNOMAG® Sealless Pumps

Lawrence Pumps®

Niigata Worthington™ Pumps

Pacific® Pumps

Pleuger® Pumps

Scienco™ Pumps

Sier-Bath® Rotary Pumps

TKL™ Pumps

United Centrifugal® Pumps

Western Land Roller™ Irrigation Pumps

Wilson-Snyder® Pumps

Worthington® Pumps

Worthington Simpson™ Pumps

**HED and HED-DS
Between Bearings,
Two-Stage, Radially
Split Pumps**

ISO 13709/API 610 (BB2)

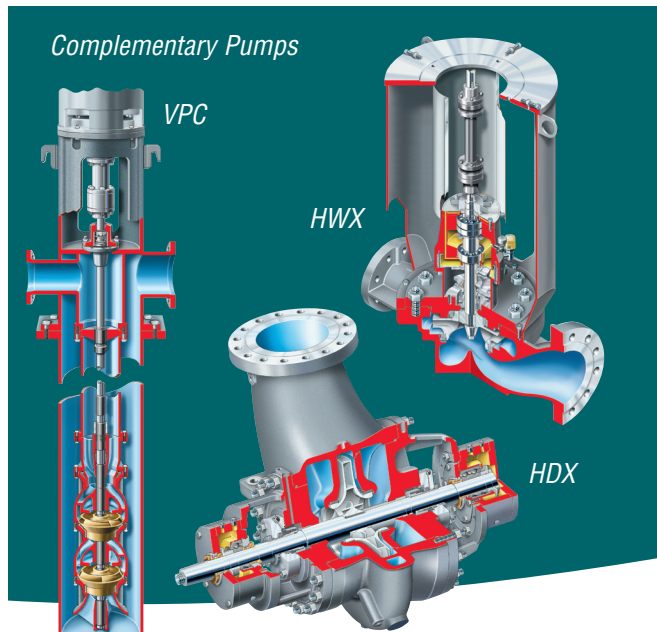
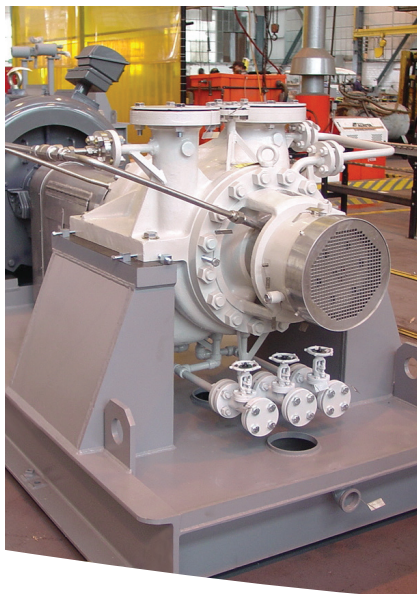

**Serving High-Pressure
Process Needs**

The HED family of two-stage, radially split pumps is particularly well suited for high-temperature process applications, such as those found in hydrocarbon processing, power and specialty services. This family of pumps fills the performance range between the single-stage HDX pump and multistage, double-case pumps.

Available with either a single- or double-suction, first-stage impeller, the pumps feature heavy-duty, single or dual volute casings with a staggered arrangement for extended pump reliability and life.

Meeting Industry Needs

The HED and HED-DS are fully compliant with ISO 13709/API 610 (BB2) standards. The pumps incorporate all of the design requirements specified by the demanding hydrocarbon processing and power industries. These include:

- ISO 13709/API 610 specified nozzle loads and shaft run-out requirements
- ISO 21049/API 682 mechanical seal chambers
- Centerline-mounted casing
- Bearing options
- Materials options
- Control and monitoring systems
- Low NPSH capabilities

Broad Application

- Petroleum refining, production and distribution
- Heavy-duty chemical and petrochemical processing
- Liquefied gas industry service
- Boiler feed
- Heavy-duty utility service

Complementary Pump Designs

Type HED and HED-DS pumps may be used with many other Flowserve pump designs, including:

- Radially split, overhung process pumps
- Single-stage, between bearings pumps
- Multistage, between bearings pumps
- Vertical, double-case pumps

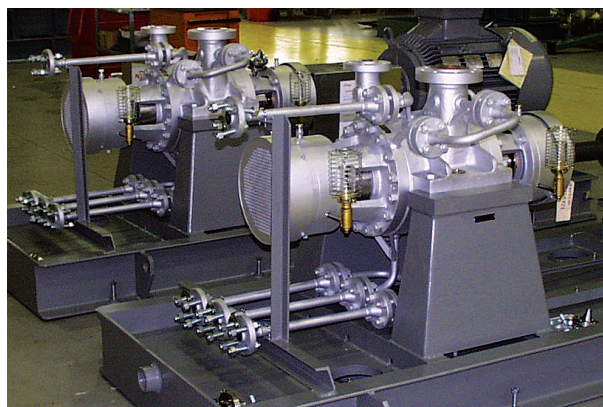

**HED and HED-DS
Between Bearings,
Two-Stage, Radially
Split Pumps**

ISO 13709/API 610 (BB2)

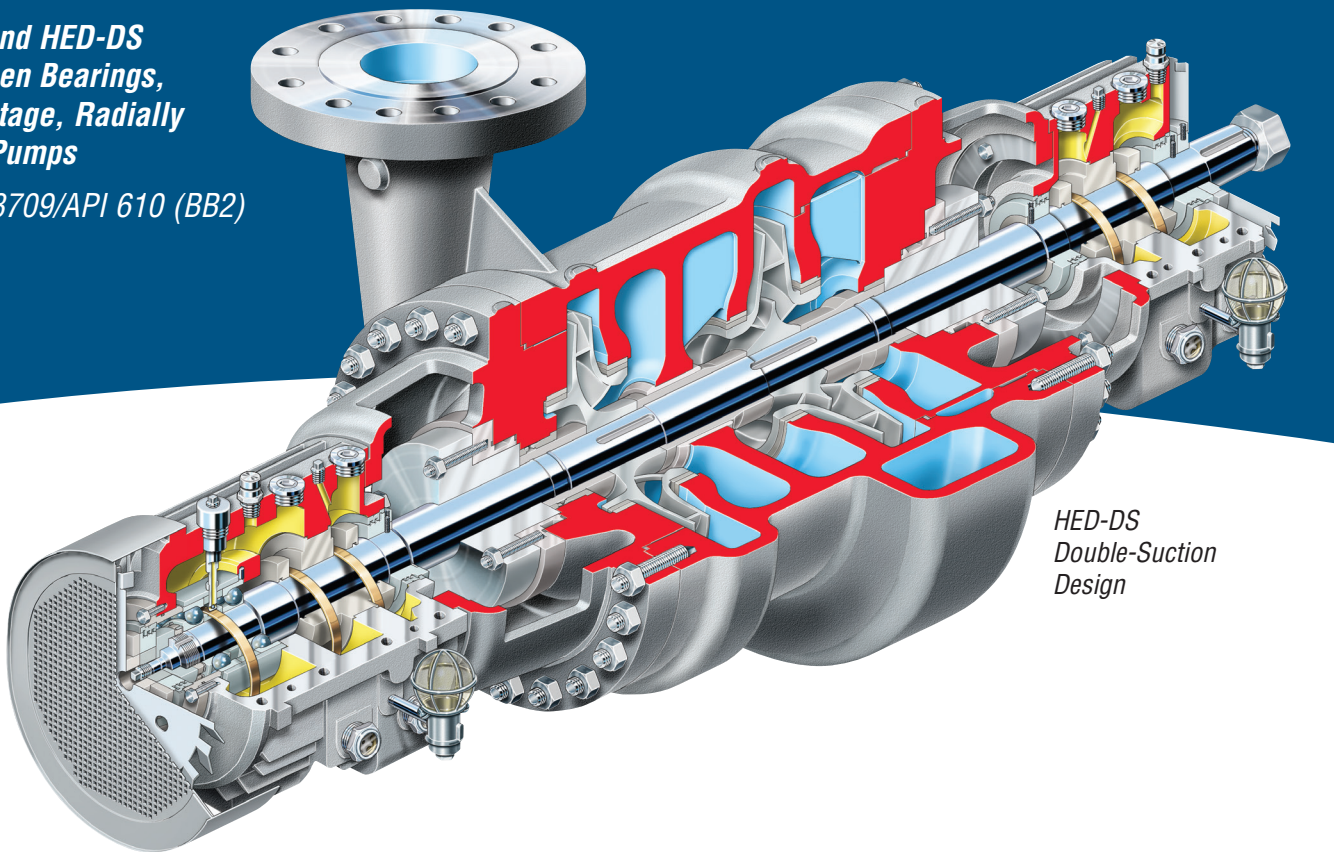

*HED-DS
Double-Suction
Design*

Fully compliant with the latest edition of ISO 13709/API 610 (BB2), the Flowserve HED pump is a between bearings, radially split, two-stage, single-suction hydrocarbon processing pump. The similarly configured HED-DS boasts a double-suction, first-stage impeller for services with very low NPSHA or higher flow rates. Both pumps are CE compliant and engineered to provide safe, reliable operation in the elevated temperatures experienced in refining and power applications.

Operating Parameters

- Flows to 2500 m³/h (11 000 gpm)
- Heads to 750 m (2460 ft)
- Pressures to 120 bar (1750 psi)
- Temperatures to 450°C (842°F)
- Speeds to 3600 rpm
- Specific gravities down to 0.35

Features and Benefits

Double Casing Covers facilitate maintenance. Gasketing is metal-to-metal fit, fully confined and controlled compression to ensure proper sealing and alignment when handling hot liquids.

ISO 21049/API 682 Seal Chamber accommodates a wide variety of seal configurations, including dual pressurized and unpressurized cartridge types for the most severe services. A full complement of ISO 13709/API 610 seal flush plans is available. Seal chambers are maintained at comparable pressures by a pressure equalizing line fitted on the discharge side chamber.

Raised Face Flanges meet ASME B16.5 criteria for Class 600. Surface finish is in accordance with ISO 13709/API 610. Class 300 and 900 flanges are available upon request.

Renewable Casing and Impeller Wear Rings are secured by locking pins or threaded dowels. Wear rings economically restore pump efficiency and maintain operational stability. Optional non-metallic wear rings are available in PEEK and other specialty materials.

Cartridge Seal Mounting ensures precise seal face setting for maximum seal life while easing maintenance.

HED and HED-DS pumps incorporate all of the design requirements specified by the demanding hydrocarbon processing and power industries.

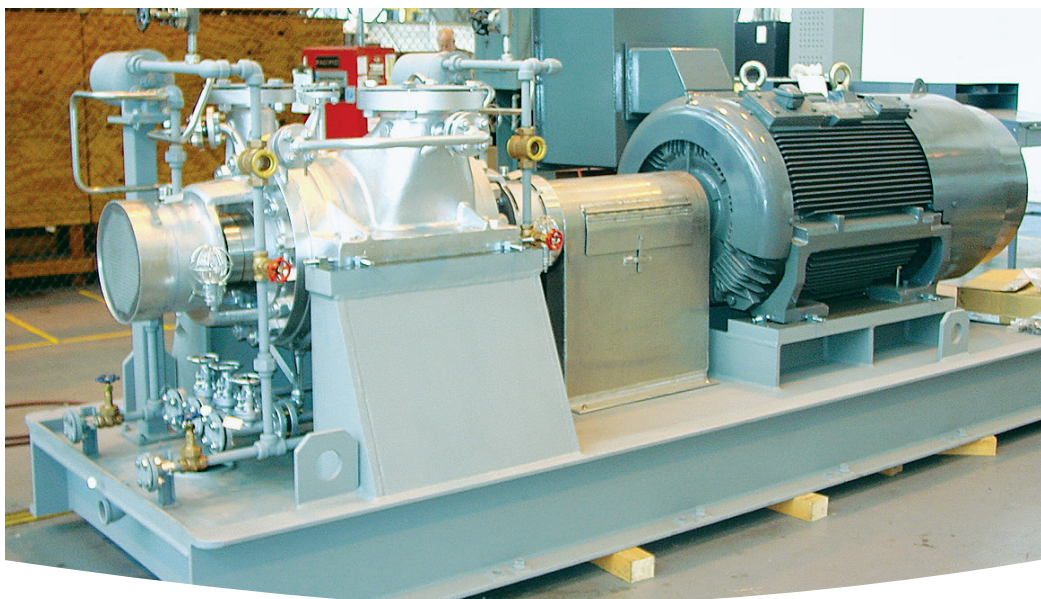

Dual Volute Construction

The HED and HED-DS feature heavy-duty casings with either single or dual volute staggered arrangement construction. Both configurations ensure radial balance over the full operating range. Detrimental shaft deflection and vibration are virtually eliminated.

Dynamically Balanced Impellers

Precision cast impellers are dynamically balanced to reduce vibration and ensure hydraulic efficiency.

- Impellers are positively locked to the shaft to eliminate vibration
- Ceramic core casting technology produces incredibly smooth passages, improving pump efficiency
- Face-to-face impeller mounting of the HED results in axial thrust balance over the entire operating range of the pump
- The double-suction, first-stage impeller of the HED-DS minimizes axial thrust problems, reduces NPSHR and allows mechanical seals to operate at equal and low pressure

Oil-Lubricated Bearings

Bearings are lubricated by means of a slinger or ring oil system. This lubrication system prolongs bearing life by ensuring the oil penetrates the bearings without foaming.

- Standard single row, self-aligning radial bearing
- Standard dual single row, back-to-back thrust bearings
- Optional bearing arrangements and lubrication system are available to meet application requirements

Carbon Steel Bearing Housing

With standard labyrinth type oil seals, the carbon steel bearing housing is designed with 360° bolting to the mounting bracket.

- Available bearing isolators prevent oil loss and contamination.
- Optional fan-cooled bearing housing permits use in extreme temperatures without water cooling systems.

Stiff Shaft Design

Stiff shafts ensure trouble-free operation below the first critical speed. A short bearing span and a heavy shaft minimize deflection under all operating conditions.

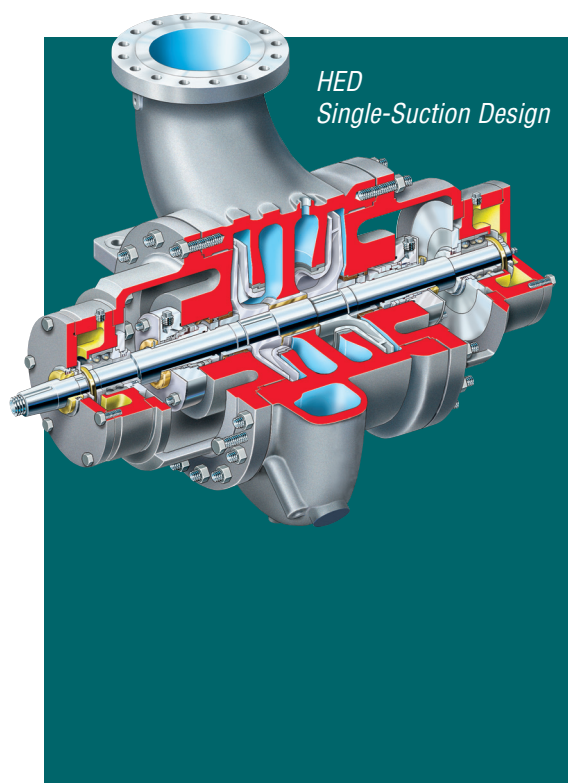

**Options and
Technical Data**

Sleeve Radial and Ball Thrust Bearings

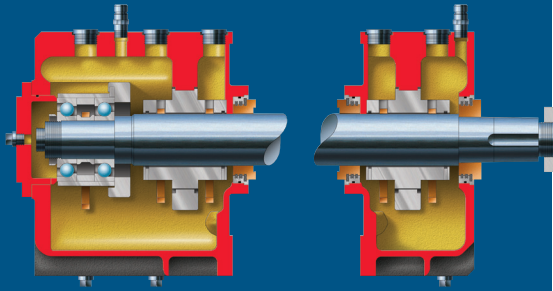

Sleeve Radial and Tilting Pad Thrust Bearings

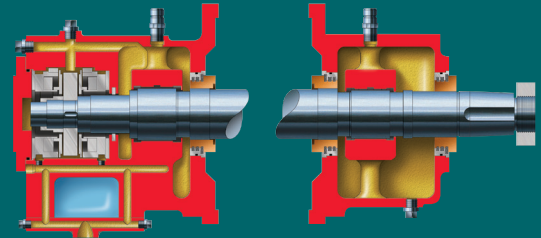

Bearing Options

- **Sleeve Radial and Ball Thrust Bearings**
 - Applied to maximum energy density (= power x rated speed) ratings of 4.0 million kW-rpm or 5.4 million hp-rpm.
 - For applications in which thrust bearing speed and life for rolling element bearings are within ISO 13709/API 610 limits.
- **Sleeve Radial and Tilting Pad Thrust Bearings**
 - Applied when energy density ratings and bearing speed or life is beyond the limits for rolling element bearings as defined by ISO 13709/API 610.
 - Tilting pad thrust bearings normally require an external forced lubrication system. Pump shaft driven or separate lube pumps available.

Shaft Options

- Hydraulic-fitted coupling
- Double extended

Available Baseplates

- Welded steel with drain rim or pan
- Sub-base under pump only
- Skid type non-grouted
- Three-point design
- Pregrouted design

Other Options

- Pure or oil mist bearing lubrication
- Water- or fan-cooled bearings
- Coatings for slurry services
- Coke crusher construction

HED Range Chart

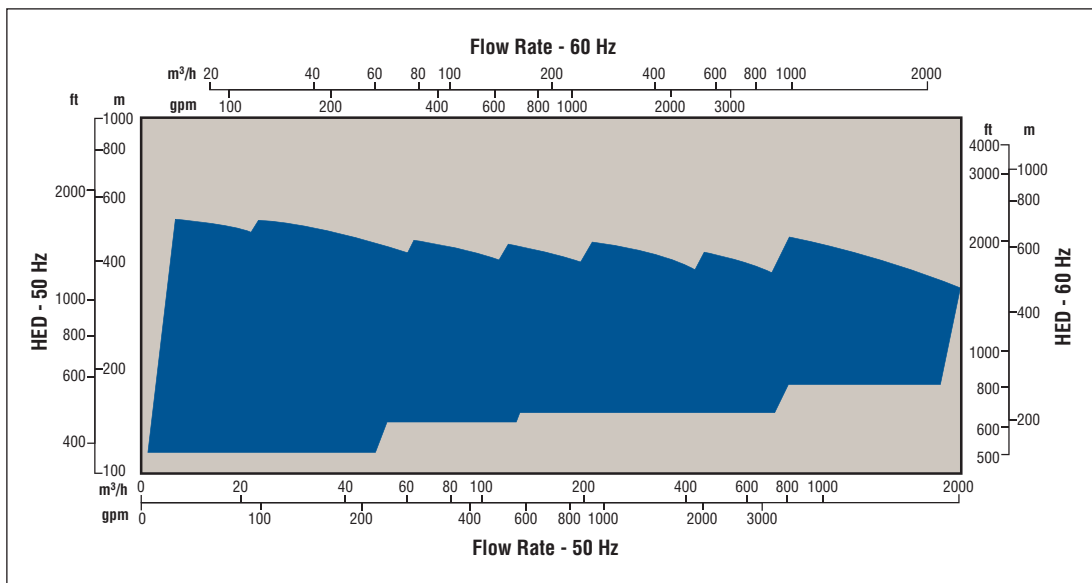

**Global Service
and Technical
Support**

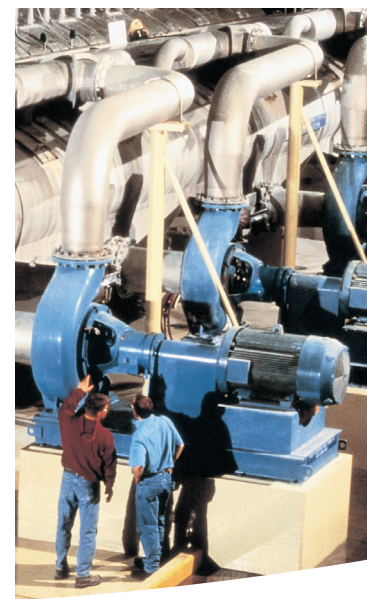
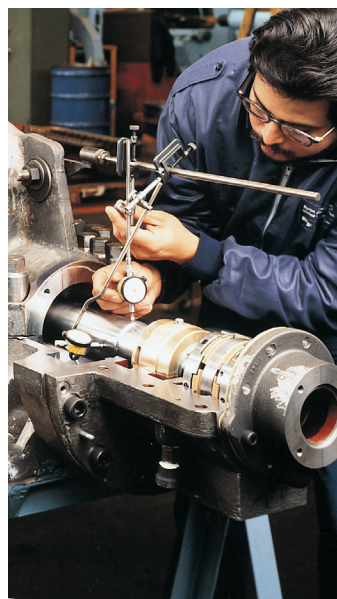

Life Cycle Cost Solutions

Typically, 90% of the total life cycle cost (LCC) of a pumping system is accumulated after the equipment is purchased and installed. Flowserve has developed a comprehensive suite of solutions aimed at providing customers with unprecedented value and cost savings throughout the life span of the pumping system. These solutions account for every facet of life cycle cost, including:

Capital Expenses

- Initial purchase
- Installation

Operating Expenses

- Energy consumption
- Maintenance
- Production losses
- Environmental
- Inventory
- Operating
- Removal

Innovative Life Cycle Cost Solutions

- New Pump Selection
- Turnkey Engineering and Field Service
- Energy Management
- Pump Availability
- Proactive Maintenance
- Inventory Management

Typical Pump Life Cycle Costs¹

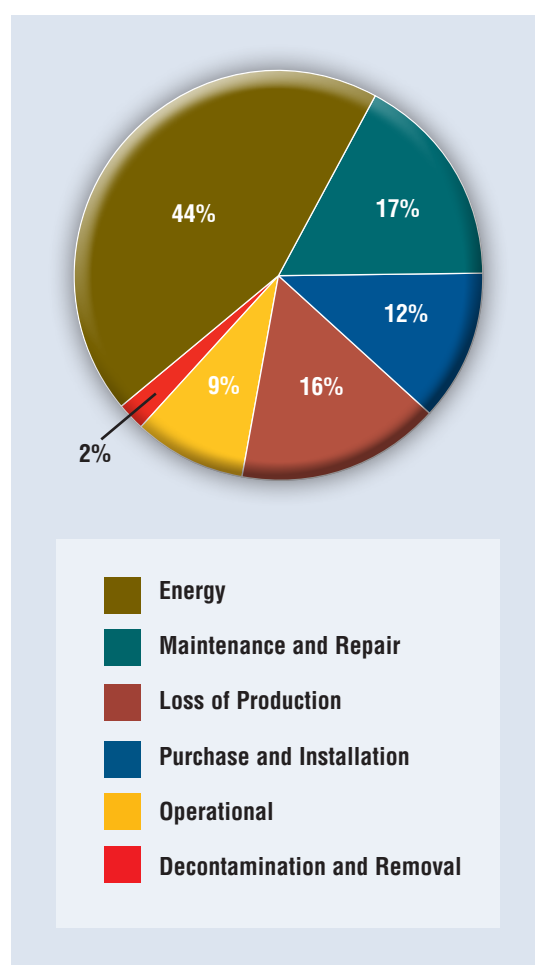

¹ While exact values may differ, these percentages are consistent with those published by leading pump manufacturers and end users, as well as industry associations and government agencies worldwide.



USA and Canada

Flowserve Corporation
5215 North O'Connor Blvd.
Suite 2300
Irving, Texas 75039-5421 USA
Telephone: +1 937 890 5839

Europe, Middle East, Africa

Flowserve Corporation
Parallelweg 13
4878 AH Etten-Leur
The Netherlands
Telephone: +31 76 502 8100

Latin America

Flowserve Corporation
Martín Rodríguez 4460
B1644CGN-Victoria-San Fernando
Buenos Aires, Argentina
Telephone: +54 11 4006 8700
Telefax: +54 11 4714 1610

Asia Pacific

Flowserve Pte. Ltd.
10 Tuas Loop
Singapore 637345
Telephone: +65 6771 0600
Telefax: +65 6862 2329

Bulletin PS-30-4d (E/A4) May 2014. © 2014 Flowserve Corporation

To find your local Flowserve representative:

For more information about Flowserve Corporation,
visit www.flowserve.com or call +1 937 890 5839.