

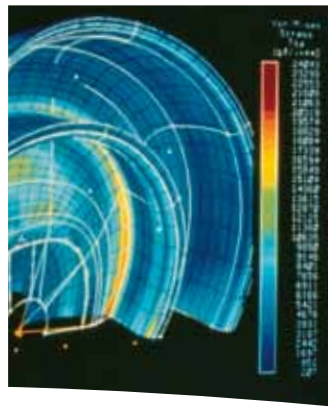

Reciprocating Pumps Horizontal and Vertical Multi-Plunger Configurations



Experience In Motion



Pump Supplier to the World

Flowserve is the driving force in the global industrial pump marketplace. No other pump company in the world has the depth or breadth of expertise in the successful application of pre-engineered, engineered and special purpose pumps and systems.

Life Cycle Cost Solutions

Flowserve is providing pumping solutions which permit customers to reduce total life cycle costs and improve productivity, profitability and pumping system reliability.

Market Focused Customer Support

Product and industry specialists develop effective proposals and solutions directed toward market and customer preferences. They offer technical advice and assistance throughout each stage of the product life cycle, beginning with the inquiry.

Broad Product Lines

Flowserve offers a wide range of complementary pump types, from pre-engineered process pumps, to highly engineered and special purpose pumps and systems. Pumps are built to recognized global standards and customer specifications.

Pump designs include:

- Single-stage process
- Between bearing single-stage
- Between bearing multistage
- Vertical
- Submersible motor
- Rotary
- Reciprocating
- Nuclear
- Specialty

Product Brands of Distinction

ACEC™ Centrifugal Pumps

Aldrich™ Pumps

Byron Jackson® Pumps

Calder™ Energy Recovery Devices

Cameron™ Pumps

Durco® Process Pumps

Flowserve® Pumps

IDP® Pumps

Lawrence Pumps®

Niigata Worthington™ Pumps

Pacific® Pumps

Pleuger® Pumps

Scienco™ Pumps

Sier-Bath® Rotary Pumps

TKL™ Pumps

United Centrifugal® Pumps

Western Land Roller™ Irrigation Pumps

Wilson-Snyder® Pumps

Worthington® Pumps

Worthington Simpson™ Pumps

**Reciprocating Pumps
Horizontal and
Vertical Multi-Plunger
Configurations**



Engineered Reciprocating Pump Solutions

FlowsERVE reciprocating pumps are inherently designed for reliable high-energy, heavy-duty service in specialized applications. Meeting API 674 design and performance criteria, each pump is engineered to provide continuous-duty operation over a 20-year design life with regular maintenance. Offering a wide variety of hydraulic, mechanical and materials options, FlowsERVE reciprocating pumps can be constructed to meet the specific characteristics of the most arduous applications, including abrasive slurries and high viscosity liquids. This results in maximum operating flexibility with minimum life cycle costs.

Pump Customization

The FlowsERVE family of engineered reciprocating pumps offers users a wide range of options to customize a solution for mission-critical pumping needs.

- Vertical and horizontal configurations
- Sectionalized or monobloc liquid ends
- Triplex, quintuplex, septuplex and nonuplex plunger configurations
- Various plunger size/stroke combinations
- High-temperature, high-pressure and slurry designs
- Custom pressures for continuous-duty pumping to 2070 bar (30 000 psi)
- Wide range of liquid end stuffing box and power end sealing arrangements, including high-temperature or environmentally hazardous services
- Wide choice of drives and drivers

Applications

- Oil and gas production
- Pipeline
- Refinery
- Chemical processing
- Power
- Primary metals processing
- Mining
- General industry
- Hydrotesting

Complementary Pump Designs

- GR Series between bearing, external gear pumps
- TSP double-suction, twin-screw pump
- WIK, WCC and HDO/HSO process barrel pumps



**Reciprocating Pumps
Horizontal and Vertical
Multi-Plunger
Configurations**

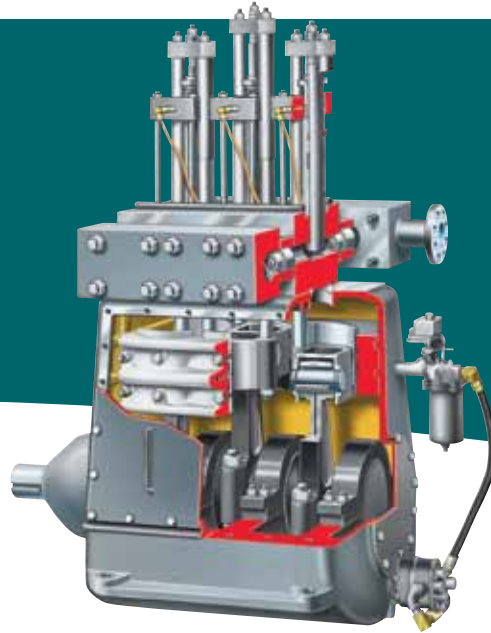
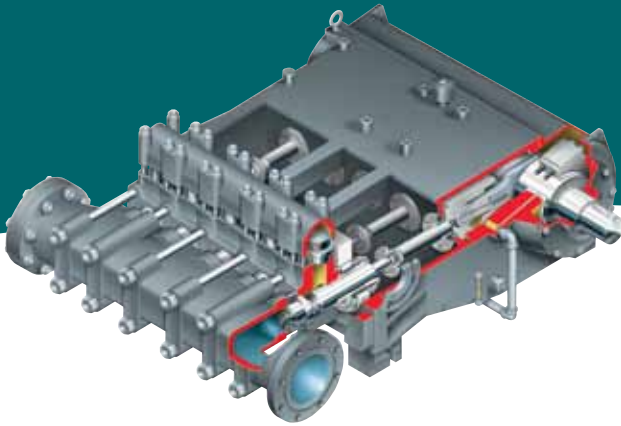

Building upon the hallmarks of its Aldrich and Worthington heritage brands, the Flowserve reciprocating pump product line provides maximum operating flexibility. Available in horizontal and vertical configurations and in numerous materials of construction, Flowserve reciprocating pumps are individually engineered to meet the specific performance and installation requirements of the application while reducing maintenance and replacement costs.

Operating Parameters

Horizontal Design With Inboard Packing Arrangement

- 75 mm (3 in) to 250 mm (10 in) stroke
- Flows to 775 m³/h (3400 gpm)
- Power to 2560 kW (3430 hp)
- Standard pressures to 555 bar (8030 psi); custom pressures to 2070 bar (30 000 psi)
- Temperatures from -40°C (-40°F) to 350°C (650°F)
- Speeds to 530 rpm

Vertical Inverted Design With Outboard Packing Arrangement

- 140 mm (5.5 in) to 225 mm (9 in) stroke
- Flows to 1140 m³/h (5000 gpm)
- Power to 3450 kW (4625 hp)
- Standard pressures to 619 bar (8975 psi); custom pressures to 2070 bar (30 000 psi)
- Temperatures from -40°C (-40°F) to 350°C (650°F)
- Speeds to 360 rpm

Features and Benefits

Two Liquid End Styles available. Sectionalized (illustrated above) is preferred for heavy-duty services like those in oil and gas. Monobloc is preferred for general industrial services.

Self-Aligning Plunger ensures proper concentricity within the stuffing box. This results in increased packing and bushing life with minimum shaft run-out.

Valve Assemblies are independent of and clamped between manifolds and liquid cylinders. This design permits valve inspection and replacement without any clean-up or machining of mating components.

Stuffing Box Assemblies are individually bolted to the liquid cylinder, allowing easy access.

Three Lip Type Seals at each horizontal crosshead extension provide oil sealing and protection against wear. Two seals point toward the crankcase to prevent oil leakage; one seal points outward to prevent atmospheric contamination.

Independent Crosshead Extension Rods provide easy access to the crankcase oil seals, keeping inspection and maintenance costs low.

Totally Enclosed Power Frame is dust and oil tight, eliminating atmospheric contamination.

Cylindrical Crossheads and Guides maximize the load bearing area to minimize bearing wear. Crosshead life is extended and replacement costs are reduced.

Splash-Type Bearing Lubrication System is contained within a sealed chamber. Lubrication is assured with oil flingers mounted on the crankshaft. Pressurized systems available.

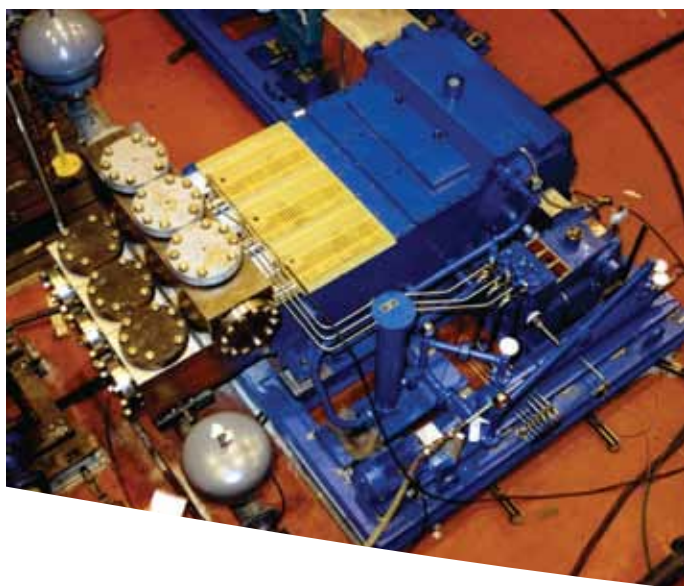

Construction Options

Flowserve reciprocating pumps are available in two configurations to suit user preference and application needs.

Sectionalized Liquid End Construction

Reciprocating pumps with sectionalized liquid end components (illustrated on page 4) provide maximum flexibility, ease of maintenance and nominal parts replacement.

- The suction and discharge manifolds and stuffing boxes are all separate components bolted to the liquid cylinder. Users are able to select materials most compatible to the liquid to extend pump life
- Pump capacity and pressure range can be changed by replacing the plunger, packing, throat bushing and following ring

Monobloc Liquid End Construction

An excellent choice for general industrial service, monobloc liquid ends (shown below) provide unparalleled maintenance convenience. Plungers and stuffing boxes can be combined into a cartridge allowing quick removal for service. Simple adjustment can be made to meet changing operating conditions. Self-contained cartridge type valves permit easy maintenance. Suction and discharge connections may be located on either side, thus simplifying installation layout.

Monobloc Liquid End

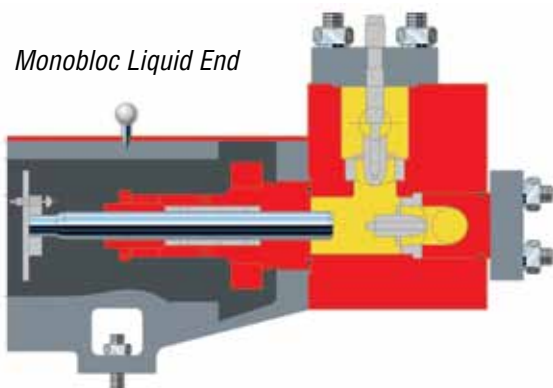

Liquid End Design Options

General Service Liquid End

Suitable for most industrial services, this construction also may be used for oil gathering and crude oil pipeline, hydraulic press, descaling, boiler feed, water flood and brine injection on and offshore.

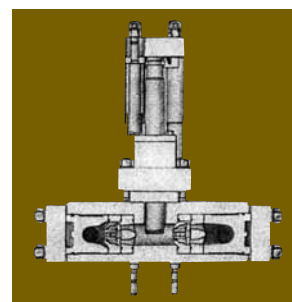

Close Clearance Liquid End

The perfect selection for handling highly volatile liquids and/or those liquids under high pressure. This design represents the most economic solution for liquefied gases, e.g., ammonia, carbon dioxide, LNG and LPG. It also is an excellent choice for reinjection for underground storage and/or secondary recovery in oil fields.

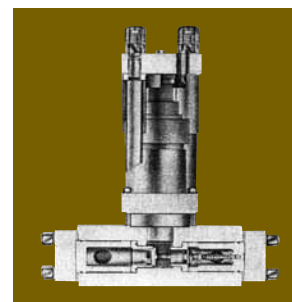

Slurry Service Liquid End

A slurry service reciprocating pump is an excellent choice for hydrotransport of minerals, ores, tailings and coal with solids concentrations up to 60% by weight. It also is proven in severe requirements for charge pumps in bitumen coal liquefaction and coal gasification plants.

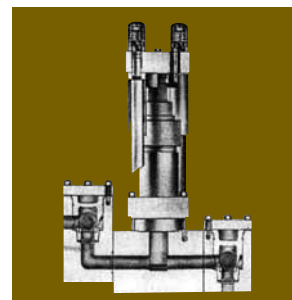

Options and Technical Data

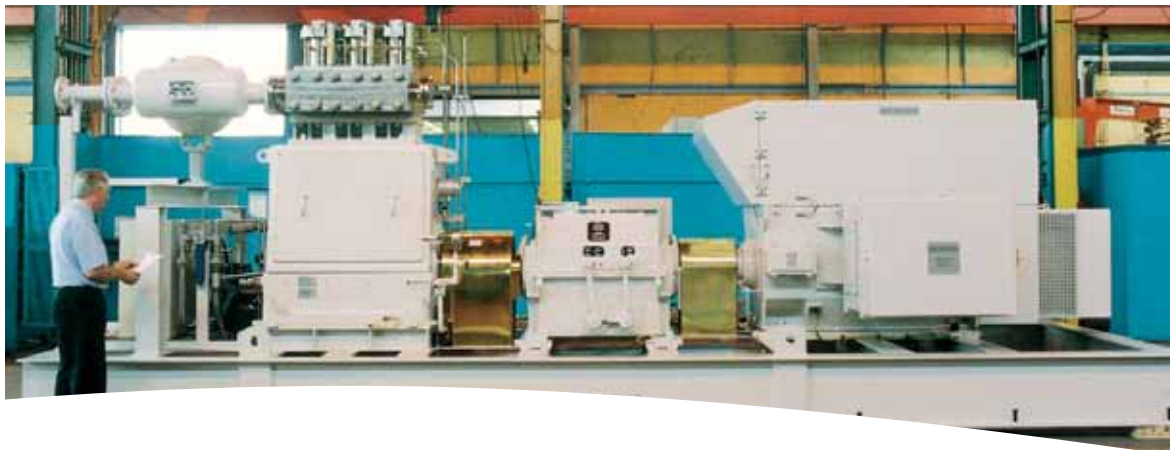

Materials Options

- Carbon, alloy and stainless steels
- High-strength bronzes
- Duplex and super duplex stainless steels
- Light reactive alloys

Sealing Options

- Spring loaded packing
- Vaporous box
- Flushed box
- Lubricated box
- Atmospheric contamination protection designs

Power End Options

- Splash lubrication
- API 674 lubrication oil system
- Forced feed lubrication
- Gravity feed lubrication
- High-suction pressure fit

Drive Options

- Gear
- V-belt
- Variable speed

Driver Options

- Electric motor
- Engine
- Turbine
- Hydraulic motor
- Top mounted motor

Available Upgrades

For heritage pumps, Flowserve offers numerous materials and design upgrades. These upgrades improve performance, extend product longevity and facilitate maintenance, resulting in increased pump availability and reduced maintenance costs.

Reciprocating Pump Range Chart

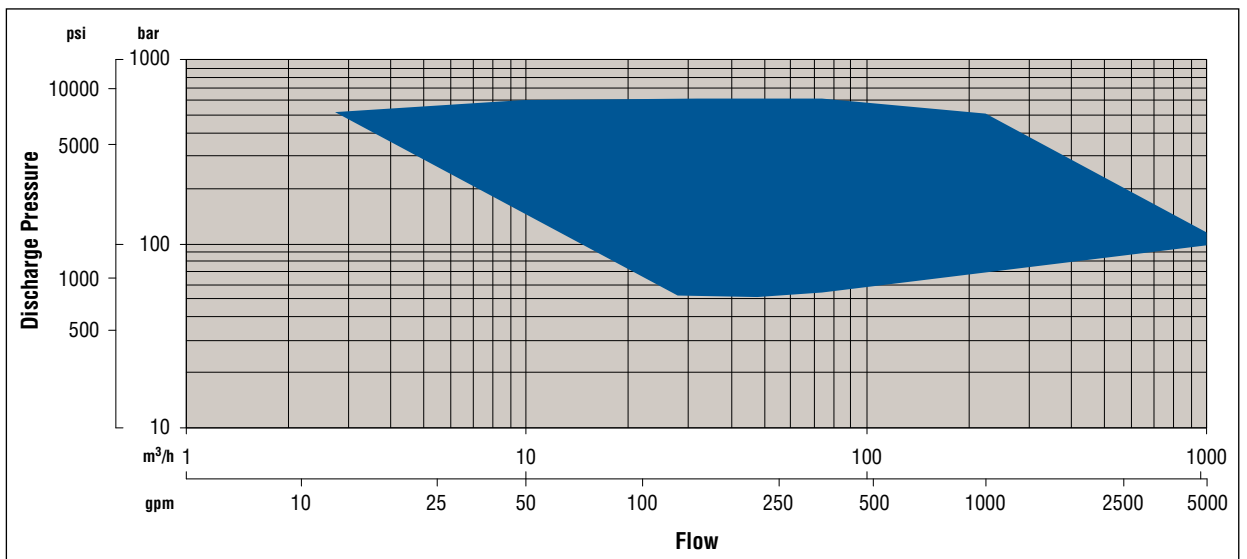

Global Service
and Technical
Support



Life Cycle Cost Solutions

Typically, 90% of the total life cycle cost (LCC) of a pumping system is accumulated after the equipment is purchased and installed. Flowserve has developed a comprehensive suite of solutions aimed at providing customers with unprecedented value and cost savings throughout the life span of the pumping system. These solutions account for every facet of life cycle cost, including:

Capital Expenses

- Initial purchase
- Installation

Operating Expenses

- Energy consumption
- Maintenance
- Production losses
- Environmental
- Inventory
- Operating
- Removal

Innovative Life Cycle Cost Solutions

- New Pump Selection
- Turnkey Engineering and Field Service
- Energy Management
- Pump Availability
- Proactive Maintenance
- Inventory Management

Typical Pump Life Cycle Costs¹

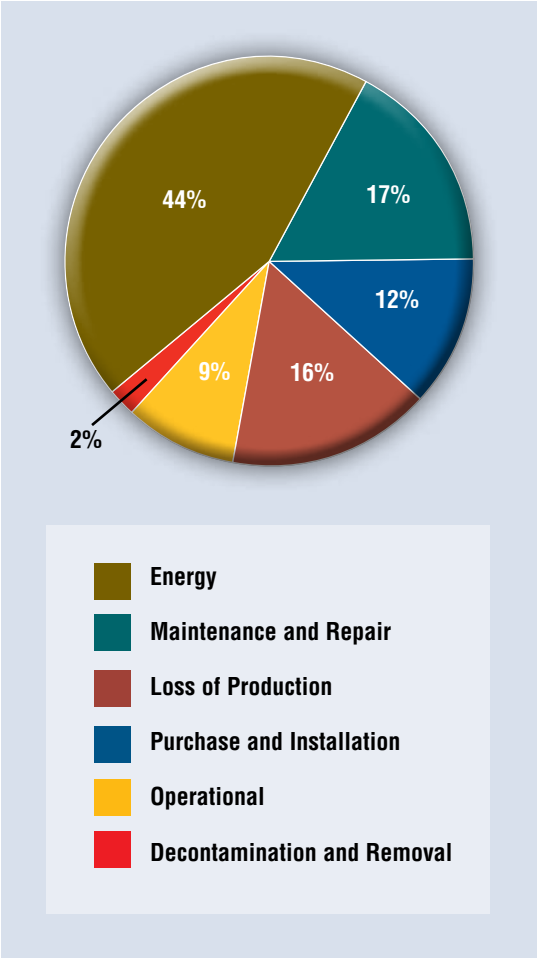

¹ While exact values may differ, these percentages are consistent with those published by leading pump manufacturers and end users, as well as industry associations and government agencies worldwide.

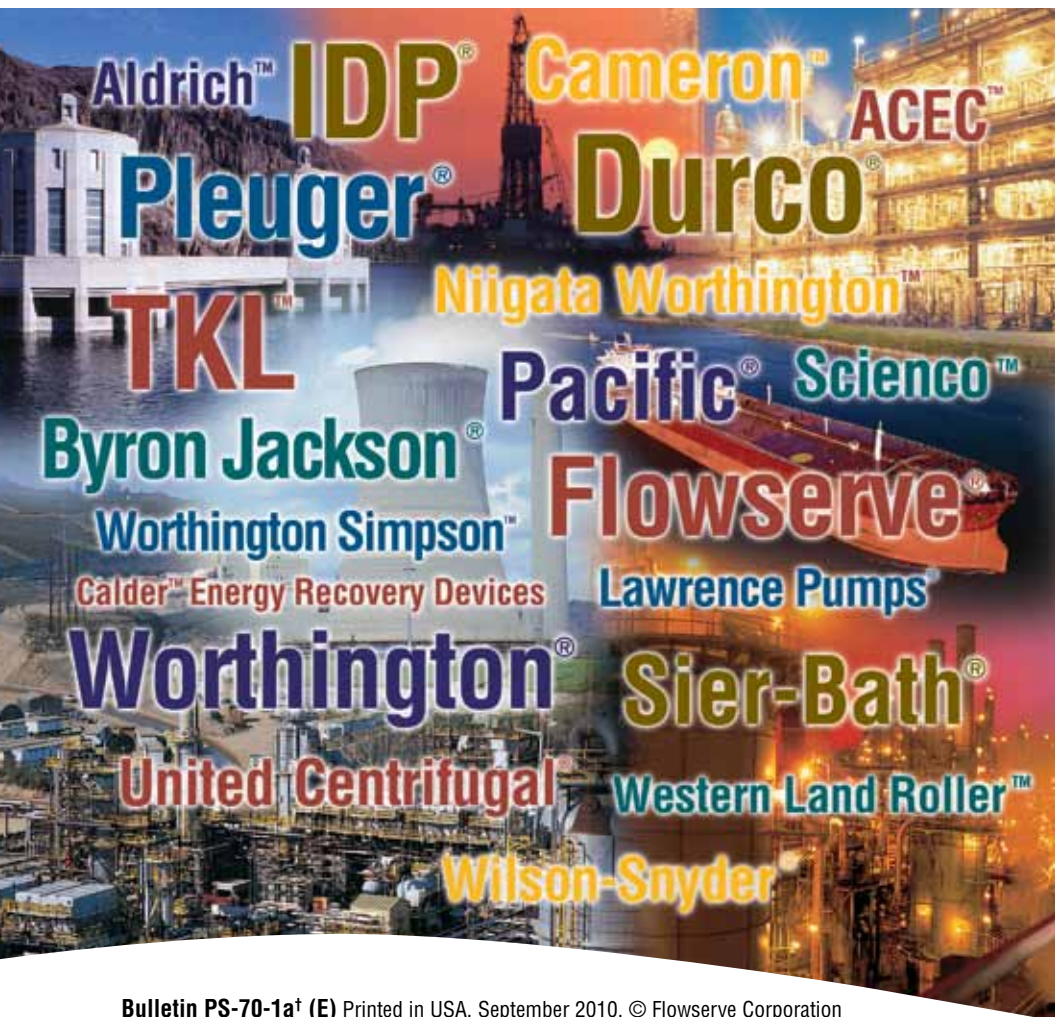

USA and Canada
Flowserve Corporation
5215 North O'Connor Blvd.
Suite 2300
Irving, Texas 75039-5421 USA
Telephone: +1 937 890 5839

Europe, Middle East, Africa
Flowserve Corporation
Gebouw Hagepoint
Westbroek 39-51
4822 ZX Breda
Netherlands
Telephone: +31 76 502 8920

Latin America
Flowserve Corporation
Martín Rodríguez 4460
B1644CGN-Victoria-San Fernando
Buenos Aires, Argentina
Telephone: +54 11 4006 8700
Telefax: +54 11 4714 1610

Asia Pacific
Flowserve Pte. Ltd.
10 Tuas Loop
Singapore 637345
Telephone: +65 6771 0600
Telefax: +65 6779 4607

Bulletin PS-70-1a† (E) Printed in USA. September 2010. © Flowserve Corporation

To find your local Flowserve representative:

For more information about Flowserve Corporation,
visit www.flowserve.com or call +1 937 890 5839