

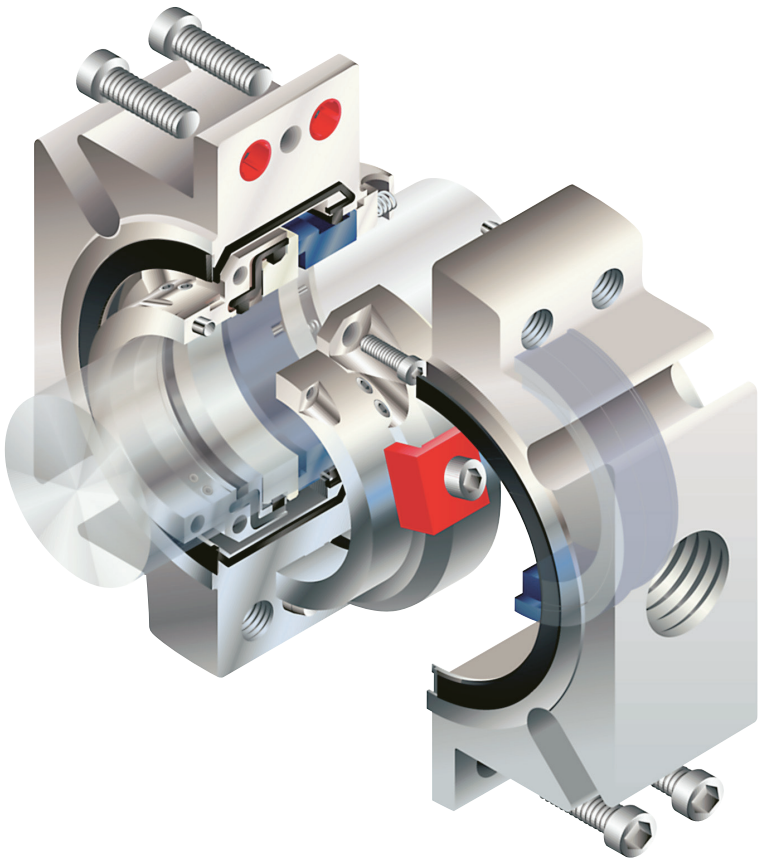

Repair Instructions

Durametallic® PSS III

Split Seal



PSS III seal reference

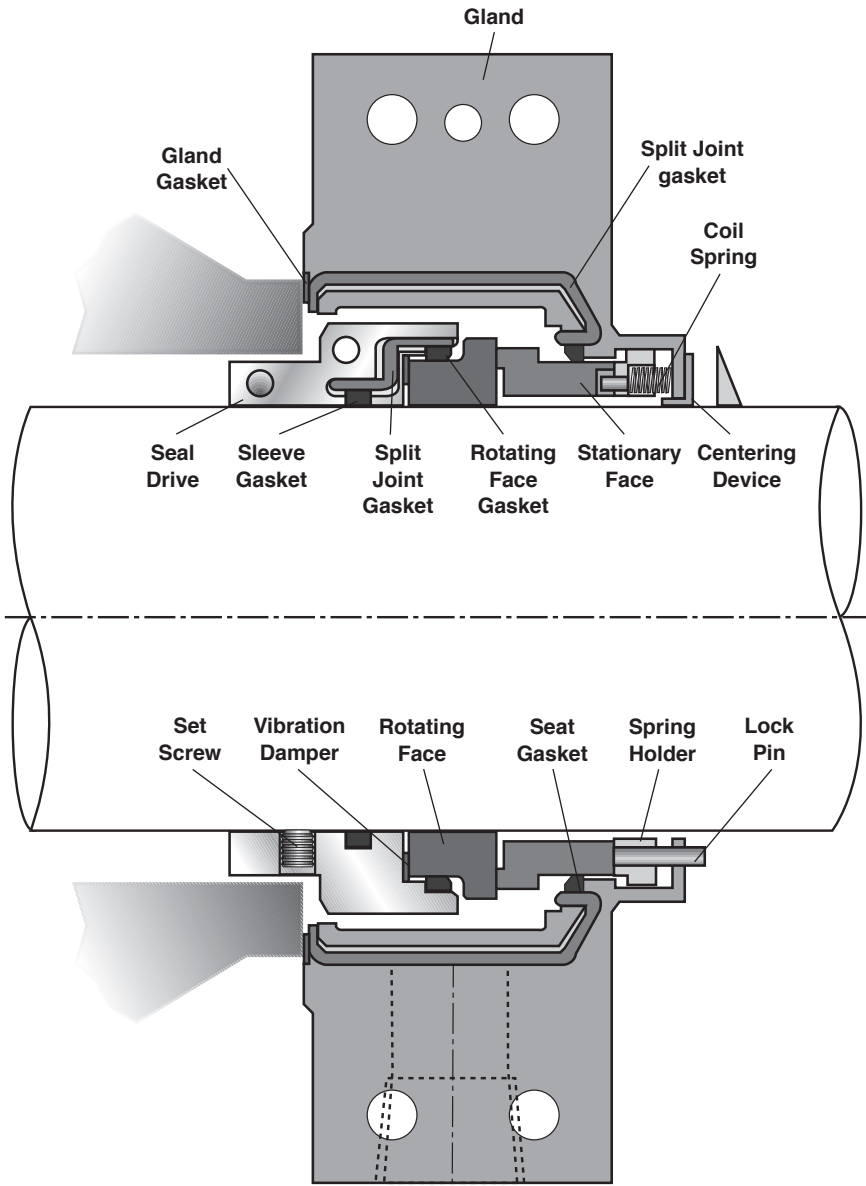

The images of parts shown in these instructions may differ visually from the actual parts due to manufacturing processes that do not affect the part function or quality.

These instructions are to be used in conjunction with the PSS III Repair Kit. The Repair Kit contains replacement seal faces, secondary seals, Loctite®¹ 430 adhesive, and Dow Corning®² 111 Silicone grease. Other small parts are shown in Figure 1. The repair should be done in a clean, well lit area. The tools you will need to do the repair include:

- Suitable solvent and rinse
- Alcohol
- Paper towels and/or swabs
- Single edged razor blade or Exacto style knife
- Common screw driver
- Hex key wrenches
- Paper clip
- Anti-seize™ thread compound

These instructions require the gluing of elastomers into position with Loctite 430. As with any cyanoacrylate, extreme care must be used when handling Loctite 430. See the enclosed Material Safety Data Sheet for details.

For special problems encountered during the repair procedure, contact your nearest Flowserve Sales and Service Representative or Authorized Distributor.

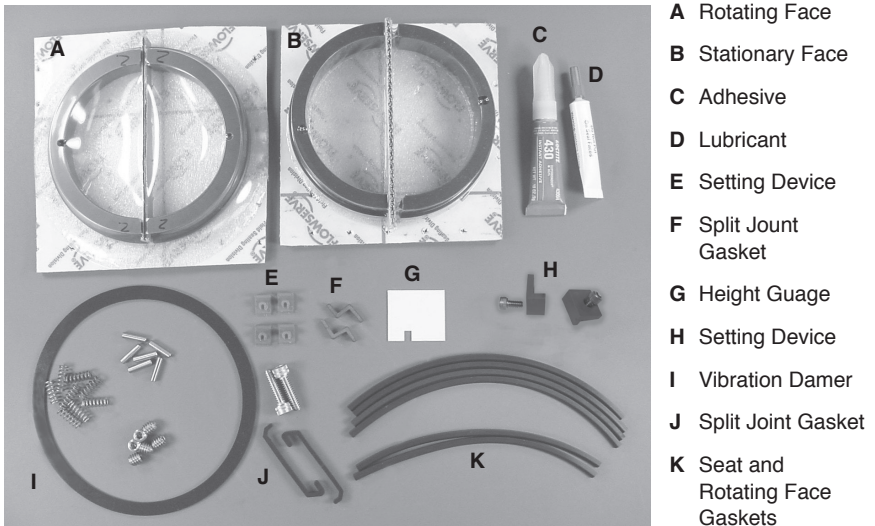

Figure 1

1 Registered Trademark of Loctite Corporation
 2 Registered Trademark of Dow Corning Corporation

1 Disassemble and Clean

- 1.1 Remove the cap screws from the seal drive and gland.
- 1.2 Remove the rotating and stationary face halves by lifting the center of each face up above their drive or lock pins and sliding the face away from the seal drive or gland.
- 1.3 Remove the spring holder by pulling out the lock pins. See Figure 2.
- 1.4 Soak the parts in a solvent to remove the secondary seals, cap screw retainers and retaining sleeves, adhesive, grease, etc. Suggested solvents include:

- Loctite X-NMS 768
- Acetone
- Trichloroethane (chloroethene)

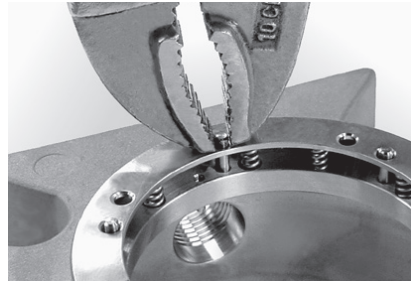

Figure 2

Note: Follow all Material Safety Data Sheet (MSDS) recommendations when handling these fluids.

- 1.5 Remove any remaining adhesive by brushing or lightly scraping.
- 1.6 Wash parts in hot soapy water. **Rinse thoroughly in clean water.** Let parts dry.

Caution: *Do not sand or bead blast gasket and joint surfaces in the seal drive and gland to avoid damaging them. Glue, rubber, or heavy deposits must be carefully scraped off these surfaces before installing the gaskets.*

2 Ongoing Inspection

During the assembly process follow these inspection procedures to avoid errors which may not be correctable later.

- 2.1 **Check Adhesion** - Gently tug at the gaskets to be sure they are properly secured. If they come loose easily, it is likely that the surfaces were not adequately cleaned or rinsed. Clean the surface again and reapply adhesive per the instructions. Apply small dots of adhesive only where specified. Dot size should be 1.00 to 2.00 mm (0.040 to 0.080 inch) in diameter.
- 2.2 **Gasket Length** - Be sure that the rotating face gasket, stationary face seat gasket, and seal drive sleeve gasket are 0.65 to 0.90 mm (0.025 to 0.035 inch) longer than the surfaces where they end. See Figure 3. If they are not, reposition them accordingly.

Note: For all standard size seals (.125 inch increments), the rotating face gasket, seat gasket and sleeve gasket are cut to the proper length at the factory and require no further trimming. These gaskets will appear to be too long for the groove. The extra length of the gasket will be compressed into the groove between the glued points at each joint during seal assembly. See Figure 7.

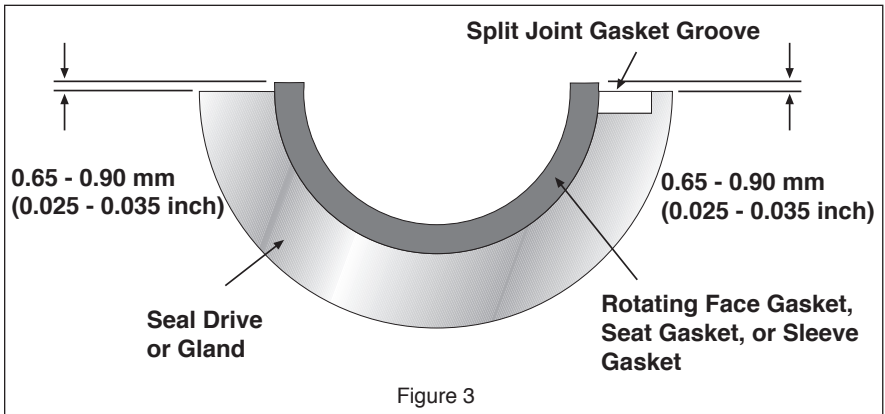

3 Seal Drive Cap Screw Retainer Installation

- 3.1 Using a sharp blade, cut the supplied 568112GU O-ring in half.
- 3.2 Apply adhesive into the 3.05 mm (0.120 inch) diameter partial hole located to the side of the cap screw hole. Push the end of one O-ring half into the hole and hold it in place for 10 seconds. When the adhesive has set up, use a sharp blade and trim the O-ring flush with the seal drive joint surface. See Figure 4.
- 3.4 Repeat this procedure for the other seal drive half.



4 Sleeve Gasket and Rotating Face Gasket Installation

- 4.1 Wipe the sleeve gasket groove clean with alcohol.

Caution: Consult material safety data sheets for proper handling of alcohol.

- 4.2 The rotating face gasket and sleeve gasket are all chamfered on one side and must be orientated as shown in Figure 5.

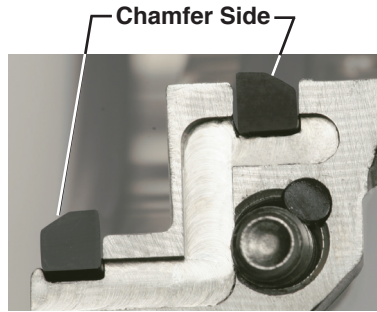

Figure 5

- 4.3 Install the sleeve gasket into the groove. Hold the gasket in the groove and adjust it so the end extends 0.65 to 0.90 mm (0.025 to 0.035 inch) past the seal drive joint surface.

- 4.4 Check the gasket extension with the height gauge. See Figure 6.

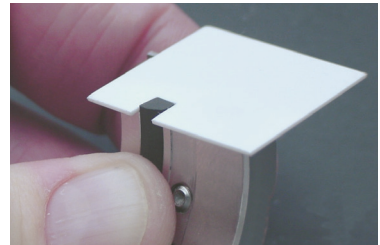

Figure 6

Note: For all standard size seals (.125 inch increments), the rotating face gasket, seat gasket, sleeve gasket are cut to the proper length at the factory and require no further trimming. These gaskets will appear to be too long for the groove. The extra length of the gasket is compressed into the groove between the glue points. See Figure 7.

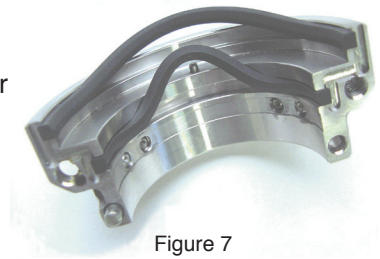

Figure 7

- 4.5 Pull back 12.7 mm (0.50 inch) of the sleeve gasket and use a paper clip to put two dots of adhesive in the groove approximately 6.35 mm (0.25 inch) and 12.7 mm (0.50 inch) from the seal drive joint surface. See Figure 8.

Note: A paper clip is recommended for applying adhesive to help control the quantity of adhesive applied



Figure 8

since too much adhesive impedes gasket flexibility and can lead to excessive leakage.

- 4.6 Push the end into the adhesive and check the gasket extension with the height gauge. Hold it in place for 10 seconds. See Figure 9.

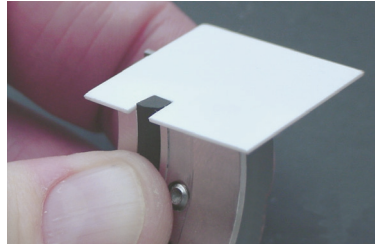

Figure 9

- 4.7 Glue the other end of the sleeve gasket in the groove using the same procedure.
- 4.8 Push the draped middle of the sleeve gasket and rotating face gasket into their grooves. Make sure these gaskets are fully seated in their grooves. **Do not** apply adhesive. See Figure 7.
- 4.9 Repeat these steps for the rotating face gasket again noting the chamfer location.
- 4.10 Repeat this procedure for the other seal drive half.

5 Seal Drive Split Joint Gasket and Cap Screw Installation

- 5.1 Each seal drive half has split gasket grooves machined into each joint surface. **The split joint gasket can be installed in either groove so long as the gaskets are located 180° apart when the seal drive is fully assembled.** See Figure 10.
- 5.2 Wipe the proper split joint gasket groove clean with alcohol.

Caution: Consult material safety data sheets for proper handling of alcohol.

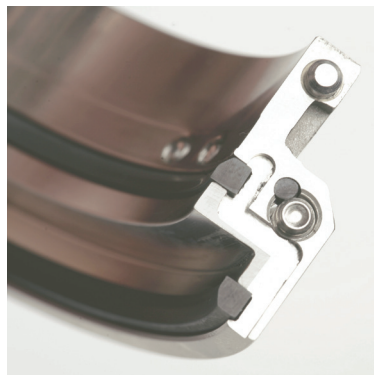

Figure 10

5.3 Put one dot of adhesive near the outer corner. See Figure 11.

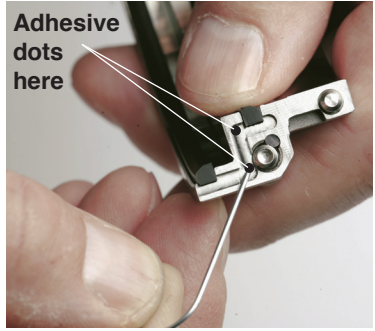

Figure 11

5.4 Put one dot of adhesive near the inner corner.

5.5 Place the split joint gasket in the groove and position it as shown in Figure 12. Hold it in place for 10 seconds. The split joint gaskets should be positioned flush with the groove surfaces as indicated.

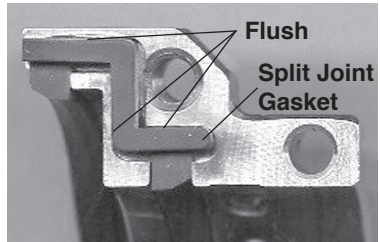

Figure 12

5.6 Coat a seal drive cap screw with anti-seize and install it through the clearance hole until it protrudes 1.02 to 1.52 mm (0.040 to 0.60 inch) past the seal drive joint. See Figure 13.

5.7 Repeat this procedure for the other seal drive half.

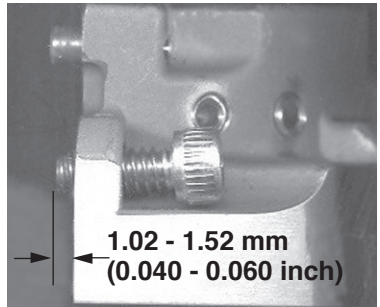

Figure 13

6 Setting Device Installation

- 6.1 Place the setting device over the locating hole and secure with the cap screw. See Figure 14.
- 6.2 Repeat this procedure for the other seal drive half.

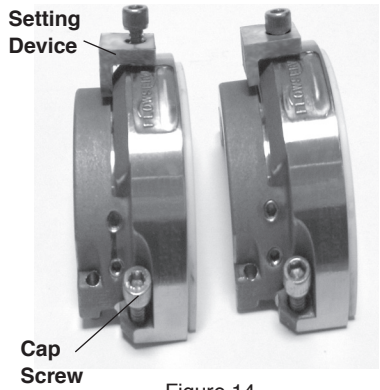

Figure 14

7 Gland Cap Screw and Retainer Sleeve Installation

- 7.1 One end of the retainer sleeve has a rib which is flush with the end of the sleeve. The end with the exposed rib is positioned to the machined side of the flange. Insert one retainer sleeve into each clearance hole. See Figure 15 and 16.



Figure 15

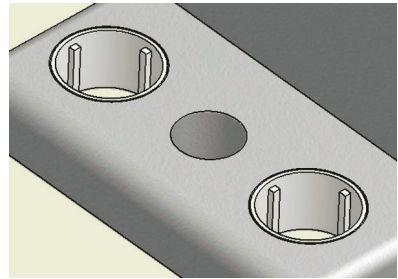

Figure 16

- 7.2 Lightly coat the gland cap screws with anti-seize and thread them through the retainer sleeves until they protrude 1.27 to 2.03 mm (0.050 to 0.080 inch) past the gland joint. See Figure 17.

- 7.3 Repeat this procedure for the other gland half.

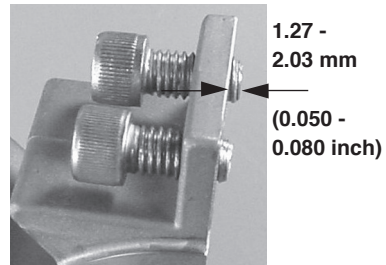

Figure 17

8 Gland Gasket Installation

- 8.1 Assemble the gland halves.
Tighten the cap screws until the gland joints are metal to metal.
- 8.2 Wipe the gland gasket groove clean with alcohol.

Caution: Consult material safety data sheets for proper handling of alcohol.

- 8.3 Using a paper clip apply a dot of adhesive in the gland gasket groove about 6.3 mm (.25 inch) from each side of the split joints, 4 dots total. Then apply dots of adhesive in the gland gasket groove, space about 12.7 to 25.4 mm (0.50 to 1 inch) apart. Do not apply adhesive closer than 6.3 mm (0.25 inch) to the split joint. See Figure 18.



Figure 18

- 8.4 Center the gland gasket in the gasket groove and hold it in place with hand pressure for 10 seconds until the adhesive sets. On larger sizes use a flat plate to ensure firm equal pressure around the entire circumference. See Figure 19.

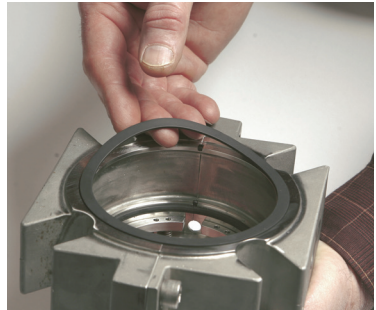

Figure 19

- 8.5 With the blade at a 20° to 30° angle from the vertical cut the gasket 3.0 to 3.8 mm (0.12 to 0.15 inch) from the one split joint. Repeat on the opposite side, 180° from the first cut. See Figure 20 and 21.

**3.18 - 3.81 mm
(0.125 - 0.150 inch)**

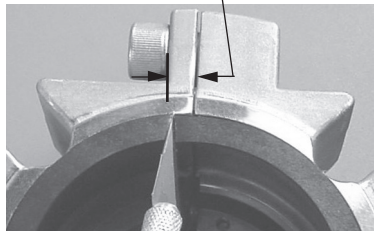

Figure 20

- 8.6 After cutting, if the overlapping gland gasket ends are stuck to the gland, use the sharp blade to gently lift them to break the bond.

9 Seat Gasket Installation

- 9.1 Wipe the gland seat gasket groove clean with alcohol.

Caution: Consult material safety data sheets for proper handling of alcohol.

- 9.2 Note the proper orientation of the chamfer and install the seat gasket into the groove. Hold the seat gasket in the groove and adjust it so the end extends 0.65 to 0.90 mm (0.025 to 0.035 inch) past the gland joint surface. See Figure 22.
- 9.3 Check the gasket extension with the height gauge. See Figure 23.
- 9.4 Pull back 12.7 mm (0.50 inch) of the seat gasket. Use a paper clip to put two dots of adhesive in the groove approximately 6.35 mm (0.25 inch) and 12.7 mm (0.50 inch) from the gland joint surface. See Figure 24.

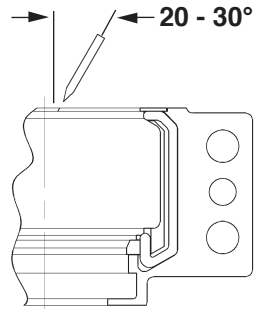

Figure 21



Figure 22

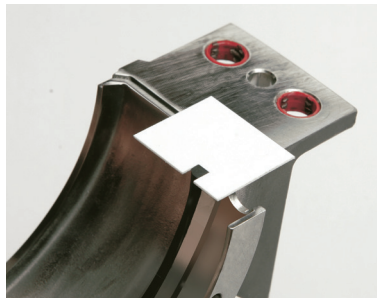

Figure 23



Figure 24

9.5 Push the end into the adhesive and check the gasket extension with the height gauge. Hold it in place for 10 seconds. See Figure 25.

9.6 Glue the other seat gasket end into the groove using the same steps.

8.7 Push the draped middle of the gasket into the groove. Make sure this gasket is fully seated in the groove. **Do not** apply adhesive.

9.8 Repeat this procedure for the other gland half.

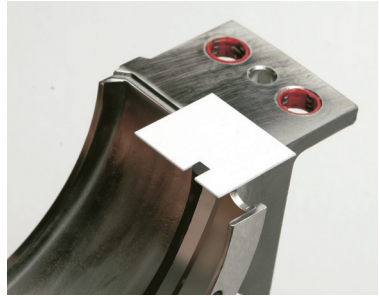

Figure 25

10 Gland Split Joint Gasket Installation

10.1 Loosen the gland cap screws and completely separate the gland halves.

10.2 Each gland half has split joint gasket grooves machined into each joint surface. **The split joint gasket should be installed in the groove of the joint surface where the threaded cap screw holes are located.**

10.3 Wipe the gland split joint gasket groove clean with alcohol.

Caution: Consult material safety data sheets for proper handling of alcohol.

Note: Care must be taken to avoid getting the adhesive too close to the seat gasket or the gland gasket. These should not be glued together.

10.4 Put three dots of adhesive in the groove as shown in Figure 26.

10.5 Place the split joint gasket in the groove. The split joint gasket should be flush with the gland gasket groove surface, top of the seat gasket, and top of the split joint gasket groove. Hold it in place for 10 seconds. See Figure 27.

10.6 Repeat this procedure for the other gland half.



Figure 26

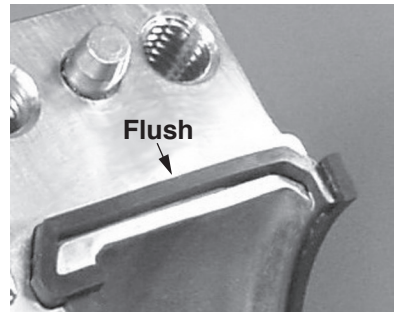

Figure 27

11 Spring Holder Installation

- 11.1 Place the coil springs in the spring holes. See Figure 28.
- 11.2 Set the gland half face down on the table and insert half of the spring holder into the gland. See Figure 29.
- 11.3 Lubricate one end of the lock pins and set them into the lock pin holes in the gland and align them with the holes in the spring holder.
- 11.4 Keep the spring holder snug in the gland bore and press the lock pins into the spring holder until the pins extend 1.5 mm (0.06 inch) out of the gland. See Figure 30.
- 11.5 Repeat this procedure for the other gland half.



Figure 28



Figure 29

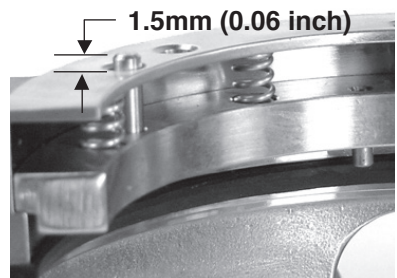

Figure 30

12 Centering Device Installation

- 12.1 Place one gland half on the table face down.
- 12.2 Position the centering devices at the gland locating holes and press their tabs into the locating holes. The locating holes are positioned 45 degrees from the split joints and are even with the bolt slots. See Figure 31.
- 12.3 Repeat this procedure for the other gland half.



Figure 31

13 Rotating Face Installation

13.1 Set the seal drive face up on the bench. Lubricate both sides of the vibration damper with silicone grease. Place the vibration damper on the seal drive rotating face support surface using the drive pin as a locator. See Figure 32.

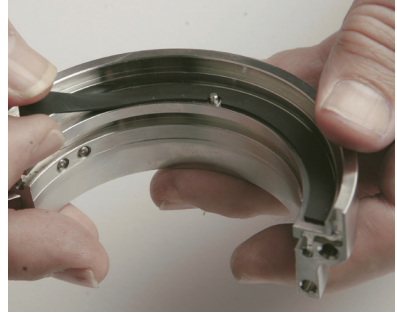

Figure 32

13.2 Lubricate the exposed surfaces of the rotating face gasket including the ends and the rotating face shoulder with silicone grease.

13.3 Position the rotating face back surface downward over the vibration damper aligning the drive pin with the pin slot.

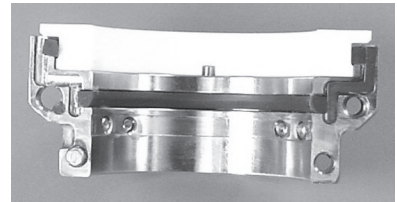

Figure 33

13.4 Push the rotating face radially into the seal drive and then down as the drive pin slips into the drive slot. The rotating face should sit flat on the vibration damper. See Figure 33.

13.5 Repeat this procedure for the other seal drive half.

13.6 Lubricate the exposed surfaces of each sleeve gasket including the ends and the split joint gaskets with silicone grease.

13.7 Wipe the rotating faces clean with alcohol.

Caution: Consult material safety data sheets for proper handling of alcohol.

14 Stationary Face Installation

14.1 Lubricate the exposed surfaces of the seat gasket including the ends, the stationary face shoulder, and the stationary face back surface that contacts the spring holder with silicon grease.

- 14.2 With the gland half sitting on the bench, position the stationary face over the spring holder as shown in Figure 34.

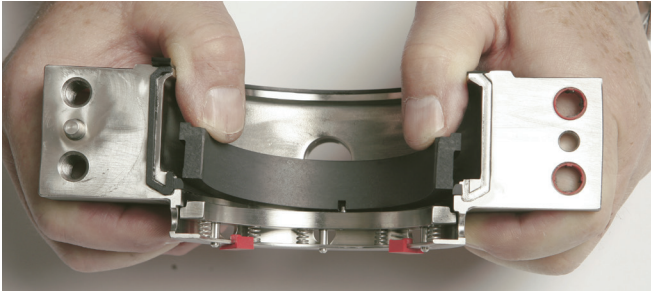

Figure 34

- 14.3 Align the lock pin a with the lock pin slot. See Figure 35.

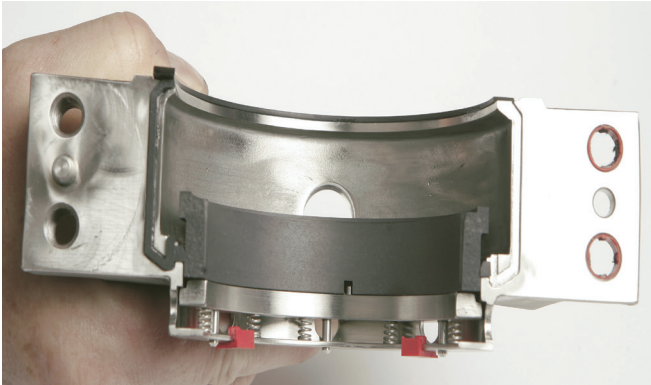

Figure 35

- 14.4 Push the stationary face radially into the gland and then down as the lock pin slips into the lock pin slot. The stationary face should sit flat on the spring holder.
- 14.5 Repeat this procedure for the other gland half.
- 14.6 Lubricate the exposed split joint gasket surfaces with silicon grease.
- 14.7 Wipe the stationary faces clean with alcohol.

Caution: Consult material safety data sheets for proper handling of alcohol.

For proper seal installation, please refer to Flowserve publication FIS175eng, PSS III Installation Instructions.



TO REORDER REFER TO
B/M # _____
F.O. _____

FIS176eng REV 09/2018 Printed in USA

***To find your local Flowserve representative
and find out more about Flowserve Corporation,
visit www.flowserve.com***

Flowserve Corporation has established industry leadership in the design and manufacture of its products. When properly selected, this Flowserve product is designed to perform its intended function safely during its useful life. However, the purchaser or user of Flowserve products should be aware that Flowserve products might be used in numerous applications under a wide variety of industrial service conditions. Although Flowserve can provide general guidelines, it cannot provide specific data and warnings for all possible applications. The purchaser/user must therefore assume the ultimate responsibility for the proper sizing and selection, installation, operation, and maintenance of Flowserve products. The purchaser/user should read and understand the Installation Instructions included with the product, and train its employees and contractors in the safe use of Flowserve products in connection with the specific application.

While the information and specifications contained in this literature are believed to be accurate, they are supplied for informative purposes only and should not be considered certified or as a guarantee of satisfactory results by reliance thereon. Nothing contained herein is to be construed as a warranty or guarantee, express or implied, regarding any matter with respect to this product. Because Flowserve is continually improving and upgrading its product design, the specifications, dimensions and information contained herein are subject to change without notice. Should any question arise concerning these provisions, the purchaser/user should contact Flowserve Corporation at any one of its worldwide operations or offices.

© 2013 Flowserve Corporation

USA and Canada

Kalamazoo, Michigan USA
Telephone: 1 269 381 2650
Telefax: 1 269 382 8726

Europe, Middle East, Africa

Etten-Leur, the Netherlands
Telephone: 31 765 028 200
Telefax: 31 765 028 487

Asia Pacific

Singapore
Telephone: 65 6544 6800
Telefax: 65 6214 0541

Latin America

Mexico City
Telephone: 52 55 5567 7170
Telefax: 52 55 5567 4224