



USER INSTRUCTIONS

Worthington® WUJ centrifugal pumps

Installation Operation Maintenance

Vertical, Multistage Wet Pit

Original Instructions

PCN=71569259, 71569260, 71569261, 71569262 05-16 (E)

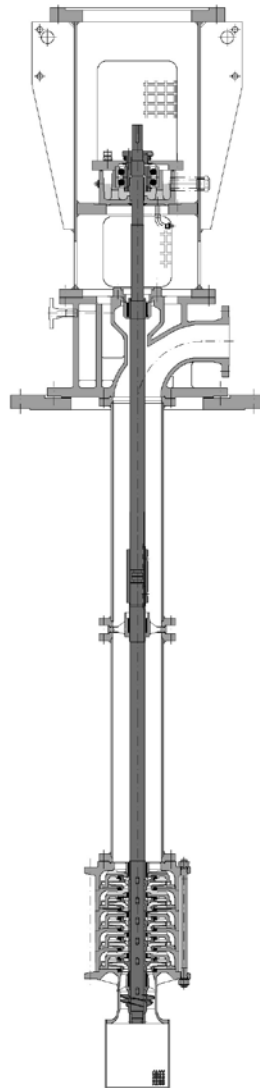

These instructions should be read prior to installing, operating, using and maintaining this equipment.

CONTENTS

	PAGE		
1.0 INTRODUCTION AND SAFETY	3	6.7 DISASSEMBLY	34
1.1 GENERAL	3	6.8 EXAMINATION OF PARTS.....	38
1.2 CE MARKING AND APPROVALS	3	6.9 ASSEMBLY	38
1.3 DISCLAIMER	3	7.0 AUXILIARIES	40
1.4 COPYRIGHT	3	7.1 SEAL AND SEAL SYSTEMS	40
1.5 DUTY CONDITIONS.....	3	8.0 FAULTS; CAUSES AND REMEDIES	43
1.6 SAFETY	4	9.0 CERTIFICATION.....	45
1.7 WARNING LABEL	9	10.0 OTHER RELEVANT DOCUMENTATION AND	
1.8 SPECIFIC MACHINE PERFORMANCE.....	10	MANUALS	45
1.9 NOISE LEVEL.....	10	10.1 SUPPLEMENTARY USER INSTRUCTIONS.....	45
1.10 CE DECLARATION	12	10.2 CHANGE NOTES.....	45
2.0 TRANSPORT AND STORAGE.....	13	10.3 ADDITIONAL SOURCES OF INFORMATION.....	45
2.1 CONSIGNMENT RECEIPT AND UNPACKING.....	13	10.4 ABBREVIATIONS	46
2.2 HANDLING	13		
2.3 LIFTING	13		
2.4 STORAGE	13		
2.5 RECYCLING AND END OF PRODUCT LIFE	13		
3.0 DESCRIPTION.....	13		
3.1 CONFIGURATION.....	13		
3.2 NOMENCLATURE.....	14		
3.3 DESIGN OF MAJOR PARTS	14		
3.4 PERFORMANCE AND OPERATING LIMITS	14		
4.0 INSTALLATION.....	15		
4.1 LOCATION	15		
4.2 PART ASSEMBLIES	15		
4.3 FOUNDATION	15		
4.4 INITIAL ALIGNMENT.....	18		
4.5 PIPING.....	19		
4.6 ELECTRICAL CONNECTIONS.....	20		
4.7 FINAL SHAFT ALIGNMENT CHECK.....	20		
4.8 PROTECTION SYSTEMS.....	20		
5.0 COMMISSIONING START-UP, OPERATION			
AND SHUTDOWN	20		
5.1 PRECOMMISSIONING PROCEDURE	20		
5.2 PUMP LUBRICANTS.....	21		
5.3 IMPELLER CLEARANCE	26		
5.4 DIRECTION OF ROTATION	27		
5.5 GUARDING	27		
5.6 PRIMING AND AUXILIARY SUPPLIES	27		
5.7 STARTING THE PUMP	28		
5.8 OPERATION.....	28		
5.9 STOPPING AND SHUTDOWN	28		
5.10 HYDRAULIC, MECHANICAL AND ELECTRICAL DUTY			
.....	29		
6.0 MAINTENANCE	29		
6.1 GENERAL	29		
6.2 MAINTENANCE SCHEDULE	30		
6.3 SPARE PARTS	30		
6.4 RECOMMENDED SPARES.....	32		
6.5 TIGHTENING TORQUE & TIGHTENING SEQUENCE..	32		
6.6 SETTING IMPELLER CLEARANCE.....	34		

1.0 INTRODUCTION AND SAFETY

1.1 General



These Instructions must always be kept close to product's operating location or directly with the product.

Flowserve's products are designed, developed and manufactured with state-of-the-art technologies in modern facilities. The unit is produced with great care and commitment to continuous quality control, utilising sophisticated quality techniques, and safety requirements.

Flowserve is committed to continuous quality improvement and being at service for any further information about the product in its installation and operation or about its support products, repair and diagnostic services.

These instructions are intended to facilitate familiarization with the product and its permitted use. Operating the product in compliance with these instructions is important to help ensure reliability in service and avoid risks. The instructions may not take into account local regulations; ensure such regulations are observed by all, including those installing the product. Always coordinate repair activity with operations personnel, and follow all plant safety requirements and applicable safety and health laws/regulations.



These instructions must be read prior to installing, operating, using and maintaining the equipment in any region worldwide. The equipment must not be put into service until all the conditions relating to safety, noted in the instructions, have been met. Failure to follow and apply the present user instructions is considered to be misuse. Personal injury, product damage, delay or failure caused by misuse are not covered by the Flowserve warranty.

1.2 CE marking and approvals

It is a legal requirement that machinery and equipment put into service within certain regions of the world shall conform with the applicable CE Marking Directives covering Machinery and, where applicable, Low Voltage Equipment, Electromagnetic Compatibility (EMC), Pressure Equipment Directive (PED) and Equipment for Potentially Explosive Atmospheres (ATEX).

Where applicable the Directives, and any additional Approvals, cover important safety aspects relating to machinery and equipment and the satisfactory provision of technical documents and safety instructions. Where applicable this document incorporates information relevant to these Directives.

To establish Approvals and if the product itself is CE Marked check the serial number plate and the Certification.

1.3 Disclaimer

Information in these User Instructions is believed to be reliable. In spite of all the efforts of Flowserve Corporation to provide sound and all necessary information the content of this manual may appear insufficient and is not guaranteed by Flowserve as to its completeness or accuracy.

Flowserve manufactures products to exacting International Quality Management System Standards as certified and audited by external Quality Assurance organisations. Genuine parts and accessories have been designed, tested and incorporated into the products to help ensure their continued product quality and performance in use. As Flowserve cannot test parts and accessories sourced from other vendors the incorrect incorporation of such parts and accessories may adversely affect the performance and safety features of the products. The failure to properly select, install or use authorised Flowserve parts and accessories is considered to be misuse. Damage or failure caused by misuse is not covered by Flowserve's warranty. In addition, any modification of Flowserve products or removal of original components may impair the safety of these products in their use.

1.4 Copyright

All rights reserved. No part of these instructions may be reproduced, stored in a retrieval system or transmitted in any form or by any means without prior permission of Flowserve.

1.5 Duty conditions

This product has been selected to meet the specifications of your purchaser order. The acknowledgement of these conditions has been sent separately to the Purchaser. A copy should be kept with these instructions.



The product must not be operated beyond the parameters specified for the application. If there is any doubt as to the suitability of the product for the application intended, contact Flowserve for advice, quoting the serial number.

If the conditions of service on your purchase order are going to be changed (for example liquid pumped, temperature or duty) it is requested that the user seeks Flowserve's written agreement before start up.

1.6 Safety

1.6.1 Summary of safety markings

These user instructions contain specific safety markings where non-observance of an instruction would cause hazards. The specific safety markings are:



DANGER

This symbol indicates electrical safety instructions where non-compliance will involve a high risk to personal safety or the loss of life.



This symbol indicates safety instructions where non-compliance would affect personal safety and could result in loss of life.



This symbol indicates "hazardous and toxic fluid" safety instructions where non-compliance would affect personal safety and could result in loss of life.



CAUTION

This symbol indicates safety instructions where non-compliance will involve some risk to safe operation and personal safety and would damage the equipment or property.



This symbol indicates "strong magnetic field" safety instructions where non-compliance would affect personal safety, pacemakers, instruments or stored data sensitive to magnetic fields.



This symbol indicates explosive atmosphere marking according to ATEX. It is used in safety instructions where non-compliance in the hazardous area would cause the risk of an explosion.



This symbol is used in safety instructions to remind not to rub non-metallic surfaces with a dry cloth; ensure the cloth is damp. It is used in safety instructions where non-compliance in the hazardous area would cause the risk of an explosion.

Note:

The sign is not a safety symbol but indicates an important instruction in the assembly process.



This symbol indicates potential risks connected with extremely high temperatures.



This symbol indicates potential risks connected with extremely low temperatures.

1.6.2 Personnel qualification and training

All personnel involved in the operation, installation, inspection and maintenance of the unit must be qualified to carry out the work involved. If the personnel in question do not already possess the necessary knowledge and skill, appropriate training and instruction must be provided. If required the operator may commission the manufacturer / supplier to provide applicable training.

Always co-ordinate repair activity with operations and health and safety personnel, and follow all plant safety requirements and applicable safety and health laws/regulations.

1.6.3 Safety action

This is a summary of conditions and actions to help prevent injury to personnel and damage to the environment and to equipment. For products used in potentially explosive atmospheres section 1.6.4 also applies.



CAUTION

PREVENT EXCESSIVE EXTERNAL PIPE LOAD

Do not use pump as a support for piping. Do not mount expansion joints so that their force, due to internal pressure, acts on the pump flange.



CAUTION

ONLY CHECK DIRECTION OF MOTOR ROTATION WITH COUPLING ELEMENT/ PINS REMOVED

Starting in reverse direction of rotation will damage the pump.



CAUTION

ENSURE CORRECT LUBRICATION

(See section 5 *Commissioning, startup, operation and shutdown.*)

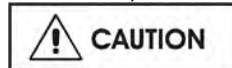

CAUTION

START THE PUMP WITH OUTLET VALVE PART OPENED

(Unless otherwise instructed at a specific point in the user instructions.)

This is recommended to avoid the risk of overloading and damaging the pump motor at full or zero flow. Pumps may be started with the valve further open only on installations where this situation cannot occur. Pump outlet valve shall be adjusted to comply with the duty following the run-up process (See section 5 *Commissioning, startup, operation and shutdown.*)

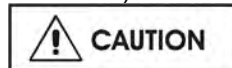

CAUTION

START THE PUMP WITH OUTLET VALVE FULLY OPEN

This is recommended to avoid the risk of overloading and damaging the pump motor where greater power is taken at low or shut off flow. Pump outlet valve shall be adjusted to comply with the duty following the

run-up process (See section 5 *Commissioning, startup, operation and shutdown*).

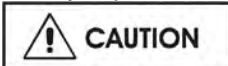

NEVER RUN THE PUMP DRY



INLET VALVES TO BE FULLY OPEN WHEN PUMP IS RUNNING

Running the pump at zero flow or below the recommended minimum flow continuously will cause damage to the seal.



DO NOT RUN THE PUMP AT ABNORMALLY HIGH OR LOW FLOW RATES

Operating at a flow rate higher than normal or at a flow rate with no back pressure on the pump may overload the motor and cause cavitation. Low flow rates may cause a reduction in pump/bearing life, overheating of the pump, instability and cavitation/vibration.

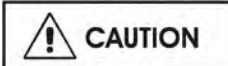

When ambient temperatures are likely to drop below freezing point, the pump and any cooling and flushing arrangements must be drained or otherwise protected.



HANDLING COMPONENTS

Many precision parts have sharp corners and the wearing of appropriate safety gloves and equipment is required when handling these components. To lift heavy pieces above 25 kg (55 lbs) use a crane corresponding to the mass and in accordance with current local regulations.



DANGER

NEVER DO MAINTENANCE WORK WHILST THE UNIT IS CONNECTED TO POWER



HAZARDOUS LIQUIDS

When the pump is handling hazardous liquids care must be taken to avoid exposure to the liquid by appropriate siting of the pump, limiting personnel access and by operator training. If the liquid is flammable and/or explosive strict safety procedures must be applied.

Gland Packing must not be used when pumping hazardous liquids.



DRAIN PUMP AND ISOLATE PIPEWORK BEFORE DISMANTLING THE PUMP

The appropriate safety precautions should be taken where the pumped liquids are hazardous.



FLUORO-ELASTOMERS (When fitted)

When a pump has experienced temperatures over 250 °C (482 °F), partial decomposition of fluoro-elastomers (example: Viton) will occur. In this

condition these are extremely dangerous and skin contact must be avoided.



GUARDS MUST NOT BE REMOVED WHILE PUMP IS OPERATIONAL



THERMAL SHOCK

Rapid changes in the temperature of the liquid within the pump can cause thermal shock, which can result in damage or breakage of components and should be avoided.



NEVER APPLY HEAT TO REMOVE IMPELLER

Trapped lubricant or vapour could cause an explosion.



HOT AND COLD PARTS

If hot or freezing components or auxiliary heating supplies can present a danger to operators, they must be shielded to avoid accidental contact. If complete protection is not possible, the machine access must be limited to maintenance staff only. Note: bearing housings must not be insulated and drive motors and bearings may be hot.

If the temperature is greater than 68 °C (155 °F) or below 5 °C (41 °F) in a restricted zone, or exceeds local regulations, action as above shall be taken.

1.6.4 Products used in potentially explosive atmospheres



Measures are required to:

- Avoid excess temperature
- Prevent build up of explosive mixtures
- Prevent the generation of sparks
- Prevent leakages
- Maintain the pump to avoid hazard

The following instructions for pumps and pump units when installed in potentially explosive atmospheres must be followed to help ensure explosion protection. Both electrical and non-electrical equipment must meet the requirements of European Directive 94/9/EC.

1.6.4.1 Scope of compliance



Use equipment only in the zone for which it is appropriate. Always check that the driver, drive coupling assembly, seal and pump equipment are suitably rated and/or certified for the classification of the specific atmosphere in which they are to be installed.

Where Flowserve has supplied only the bare shaft pump, the Ex rating applies only to the pump. The party responsible for assembling the pump set shall

select the coupling, driver and any additional equipment, with the necessary CE Certificate/ Declaration of Conformity establishing it is suitable for the area in which it is to be installed.

The motor, coupling, pump thrust bearing and seal can be made compliant with 2014/34/EU ATEX Directive for Equipment Categories 2 and 3 as required by the duty conditions.

See the pump nameplate and Declaration of Conformity for the pump classification. The pump column below soleplate will also generally be to the same category however in some applications the section of the pump below soleplate and above liquid will have been designed to Category 1, whereas above soleplate Category 2 or 3 will apply. (See section 1.6.4.2.).

The pump will then be supplied with a copy of the Certificate of Approval by a Notified Body and marked with both categories. Users must pay particular attention to pump operation and maintenance instructions because of the hazard of the explosive atmosphere.

The output from a variable frequency drive (VFD) can cause additional heating affects in the motor and so, for pump sets with a VFD, the ATEX Certification for the motor must state that it covers the situation where electrical supply is from the VFD. This is particular requirement still applies even if the VFD is in a safe area.

1.6.4.2 Marking

An example of ATEX equipment marking is shown below. The actual classification of the pump will be engraved on the nameplate or in the case of Category 1, below the soleplate on a special ATEX marking plate.

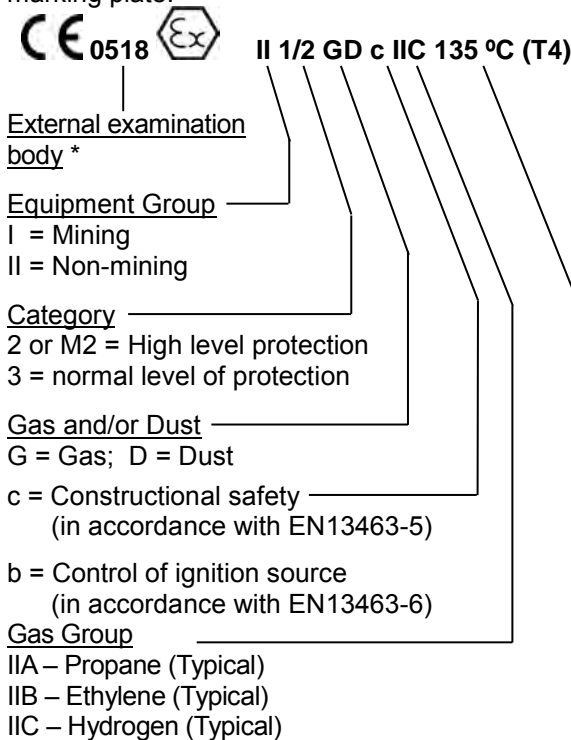

(see section 1.6.4.3.)

Note: *The external ATEX examination body reference is included in the pump marking when the Category is 1/2 or 1/3. In that situation, the 1 before the /2 or /3 identifies the special case where the pump is Category 1 below the soleplate and 2 or 3 above the soleplate. For ATEX Group II Category 1 below the soleplate a special ATEX marking plate is used. An example of this is shown below.

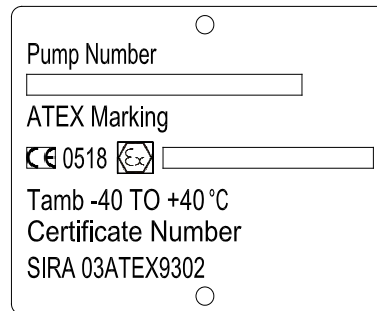

1.6.4.3 Avoiding excessive surface temperatures

Ex ENSURE THE EQUIPMENT TEMPERATURE CLASS IS SUITABLE FOR THE HAZARD ZONE

Pumps have a temperature class as stated in the ATEX Ex rating on the nameplate. These are based on an ambient in the range of -80 to +55 °C (-112 to +131 °F); refer to Flowserve for ambient temperatures outside this range for this product.

The surface temperature on the pump is influenced by the temperature of the liquid handled. The maximum permissible liquid temperature depends on the ATEX temperature class and must not exceed the values in the table that follows.

Temperature class to EN 13463-1	Maximum surface temperature permitted	Temperature limit of liquid handled (* depending on material and construction variant - check which is lower)
T6	85 °C (185 °F)	Consult Flowserve
T5	100 °C(212 °F)	Consult Flowserve
T4	135 °C (275 °F)	115 °C (239 °F) *
T3	200 °C (392 °F)	180 °C (356 °F) *
T2	300 °C (572 °F)	275 °C (527 °F) *
T1	450 °C (842 °F)	400 °C (752 °F) *

* The table only takes the ATEX temperature class into consideration. Pump design or material, as well as component design or material, may further limit the maximum working temperature of the liquid.

The temperature rise at the seals and bearings and due to the minimum permitted flow rate is taken into account in the temperatures stated.

The responsibility for compliance with the specified maximum liquid temperature is with the plant operator.

Temperature classification “Tx” is used when the liquid temperature varies and when the pump is required to be used in differently classified potentially explosive atmospheres. In this case the user is responsible for ensuring that the pump surface temperature does not exceed that permitted in its actual installed location.

Do not attempt to check the direction of rotation with the coupling element/pins fitted due to the risk of severe contact between rotating and stationary components.

Where there is any risk of the pump being run against a closed valve generating high liquid and casing external surface temperatures it is recommended that users fit an external surface temperature protection device.

Avoid mechanical, hydraulic or electrical overload by using motor overload trips or a Power Monitor and make routine vibration monitoring.

In dirty or dusty environments, regular checks must be made and dirt removed from areas around close clearances, bearing housings and motors.

The equipment utilises polymer based seals and bearing surfaces that could be corroded if they are in contact with unsuitable liquids or gases. These surfaces are important for the operation of the pump. Contact Flowserve if you are uncertain about the performance of these materials with respect to aggressive substances that may be present in the hazardous area.

The pump casing must be flooded with liquid to the minimum level on the dimensional General Arrangement (GA) drawing, at any time that the pump is operated. On pumps furnished to Group II Category 1 below the soleplate, monitoring of the level with a pump cut out on low level is required.

For pumps furnished to Category 1/2 and 1/3, if the pump is operating remotely without regular checking, it must be installed with continuous monitoring of vibration level, set to shut down the pump at high vibration levels, see also section 5.8.1.

1.6.4.4 Preventing the build up of explosive mixtures



ENSURE THE PUMP IS PROPERLY FILLED AND VENTED AND DOES NOT RUN DRY

Ensure the pump and relevant suction and discharge pipeline system is totally filled with liquid at all times

during the pump operation, so that an explosive atmosphere is prevented. In addition it is essential to make sure that seal chambers, auxiliary shaft seal systems and any heating and cooling systems are properly filled.

If the operation of the system cannot avoid this condition the fitting of an appropriate Dry Run protection device is recommended (eg liquid detection or a Power Monitor).

To avoid potential hazards from fugitive emissions of vapour or gas to atmosphere the surrounding area must be well ventilated.

1.6.4.5 Preventing sparks



To prevent a potential hazard from mechanical contact the coupling guard must be non-sparking and anti-static.

To avoid the potential hazard from random induced current generating a spark the earth contact on the baseplate must be used.



Avoid electrostatic charge: do not rub non-metallic surfaces with a dry cloth; ensure cloth is damp.

The coupling must be selected to comply with 94/9/EC and correct alignment must be maintained.

1.6.4.6 Preventing leakage



The pump must only be used to handle liquids for which it has been approved to have the correct corrosion resistance.

Avoid entrapment of liquid in the pump and associated piping due to closing of suction and discharge valves, which could cause dangerous excessive pressures to occur if there is heat input to the liquid. This can occur if the pump is stationary or running.

Bursting of liquid containing parts due to freezing must be avoided by draining or protecting the pump and ancillary systems.

Where there is the potential hazard of a loss of a seal barrier fluid or external flush, the fluid must be monitored.

If leakage of liquid to atmosphere can result in a hazard, the installation of a liquid detection device is recommended.

1.6.4.7 Maintenance to the centrifugal pump to avoid the hazard



CORRECT MAINTENANCE IS REQUIRED TO AVOID POTENTIAL HAZARDS WHICH GIVE A RISK OF EXPLOSION

The responsibility for compliance with maintenance instructions is with the plant operator.

To avoid potential explosion hazards during maintenance, the tools, cleaning and painting materials used must not give rise to sparking or adversely affect the ambient conditions. Where there is a risk from such tools or materials, maintenance must be conducted in a safe area.

It is recommended that a maintenance plan and schedule is adopted (see section 6, *Maintenance*).to include the following.

- a) Any auxiliary systems installed must be monitored, if necessary, to ensure they function correctly.
- b) Gland packings must be adjusted correctly to give visible leakage and concentric alignment of the gland follower to prevent excessive temperature of the packing or follower.
- c) Check for any leaks from gaskets and seals. The correct functioning of the shaft seal must be checked regularly
- d) Check bearing lubricant level, and if the hours run show a lubricant change is required.
- e) Check that the duty condition is in the safe operating range for the pump.
- f) Check vibration, noise level and surface temperature at the bearings to confirm satisfactory operation.
- g) Check dirt and dust is removed from areas around close clearances, bearing housings and motors.
- h) Check coupling alignment and re-align if necessary.

1.7 Warning label





WARNING

ESSENTIAL PROCEDURES BEFORE STARTING:



INSTALL AND OPERATE EQUIPMENT ONLY IN ACCORDANCE WITH THE INSTRUCTION MANUAL SUPPLIED SEPERATELY!







ENSURE GUARDS ARE SECURELY IN PLACE!



ENSURE ALL EXTERNAL CONNECTIONS TO THE PUMP / SHAFT SEALING AND DRIVER ARE CONNECTED AND OPERATIONAL!







FILL PRIME UNIT AND SYSTEMS. DO NOT RUN DRY!
ENSURE UNIT ON A FIRM FOUNDATION!



COUPLING FACES ARE IN CORRECT ALIGNMENT PRIOR TO AND AFTER BOLTING BASEPLATE DOWN AND FIXING PIPEWORK!



SEE MANUAL FOR TOLERANCES!



ENSURE CORRECT DRIVER DIRECTION OF ROTATION WITH COUPLING ELEMENT / PINS REMOVED. OTHERWISE SERIOUS DAMAGE MAY RESULT!



CAUTION



THIS MACHINE MUST BE FILLED WITH OIL BEFORE STARTING!



FAILURE IN FOLLOWING THESE PROCEDURES MAY RESULT IN PERSONAL INJURY / OR EQUIPEMENT DAMAGE!



AK-WARN-(en)-05/00

1.8 Specific machine performance

For performance parameters see section 1.5, *Duty conditions*. When the Contract requirement specifies these to be incorporated into user instructions these are included here. Where performance data has been supplied separately to the purchaser these should be obtained and retained with these user instructions if required.

1.9 Noise level

Attention must be given to the exposure of personnel to the noise, and local legislation will define when guidance to personnel on noise limitation is required, and when noise exposure reduction is mandatory. This is typically 80 to 85 dBA.

The usual approach is to control the exposure time to the noise or to enclose the machine to reduce emitted sound. You may have already specified a limiting noise level when the equipment was ordered, however if no noise requirements were defined, then attention is drawn to the following table to give an indication of equipment noise level so that you can take the appropriate action in your plant.

Pump noise level is dependent on a number of operational factors, flow rate, pipework design and acoustic characteristics of the building, and so the values given are subject to a 3 dBA tolerance and cannot be guaranteed.

Similarly the motor noise assumed in the “pump and motor” noise is that typically expected from standard and high efficiency motors when on load directly driving the pump. Note that a motor driven by an inverter may show an increased noise at some speeds.

If a pump unit only has been purchased for fitting with your own driver then the “pump only” noise levels in the table should be combined with the level for the driver obtained from the supplier. Consult Flowserve or a noise specialist if assistance is required in combining the values.

It is recommended that where exposure approaches the prescribed limit, then site noise measurements should be made.

The values are in sound pressure level L_{pA} at 1 m (3.3 ft) from the machine, for “free field conditions over a reflecting plane”.

For estimating sound power level L_{WA} (re 1 pW) then add 14 dBA to the sound pressure value.

	dB(A) Value	Octave MID BAND frequency [Hz]							
		63	125	250	500	1 K	2 K	4 K	8 K
Motorstand 0									
1450 rpm	57	48	52	52	50	50	50	48	43
1760 rpm	59	50	54	54	52	52	52	50	45
2900 rpm	61	52	56	56	54	54	54	52	47
3600 rpm	63	54	58	58	56	56	56	54	49
Motorstand 1									
3000 rpm	70	60	64	64	62	62	62	60	55
1500 rpm	64	54	58	58	56	56	56	54	49
3600 rpm	72	62	66	66	64	64	64	62	57
1800 rpm	64	54	58	58	56	56	56	54	49
Motorstand 3									
3000 rpm	72	62	66	66	64	64	64	62	57
1500 rpm	66	56	60	60	58	58	58	56	51
3600 rpm	74	64	68	68	66	66	66	64	59
1800 rpm	67	57	61	61	59	59	59	57	52
Motorstand 4									
3000 rpm	73	63	67	67	65	65	65	63	58
1500 rpm	68	58	62	62	60	60	60	58	53
1800 rpm	69	59	63	63	61	61	61	59	54
Motorstand 5									
3000 rpm	74	64	68	68	66	66	66	64	59
1500 rpm	69	59	63	63	61	61	61	59	54
1800 rpm	70	60	64	64	62	62	62	60	55
Motorstand 6									
1500 rpm	70	60	64	64	62	62	62	60	55
1800 rpm	71	61	65	65	63	63	63	61	56
Motorstand 7									
1500 rpm	71	61	65	65	63	63	63	61	56
1800 rpm	72	62	66	66	64	64	64	62	57
Motorstand 8									
1500 rpm	73	63	67	67	65	65	65	63	59
1800 rpm	74	64	68	68	66	66	66	64	60

Sound pressure readings are for information only and are not subject to guarantee by Flowserve/IDP.

Decibel readings do not include driver or system noise.

Pump tested at 100% of the best efficiency point at max. impeller diameter with water.

dB correction for combining noises (pump+motor)

Difference between two levels to be combined, dB	0	1	2	4	6	9	10
Add to the higher level to obtain the combined noise level, dB	3	2.5	2	1.5	1	0.5	0





Note :

- 1) The values showed are measured at a distance of 1 mt. (horizontally) from major pump surfaces and 1.5 mt. above the floor.
- 2) The values shown are expressed in dB (A)
- 3) For Noise Test Procedure refer to Works Standard L-109
- 4) The values shown have been derived from actual noise-test data and are based on the following conditions:
 - Equipment is located in a free field above a reflecting plane in which the reduction in noise level in all directions is 6db in each octave band for each doubling of distance.
 - Background noise is 10dB minimum below all noise levels in each octave band.
 - The values shown are at a distance of 1 meter (horizontally) from the major pump surface and 1,5 meters above the floor, using a standard pressure reference of 0,00002 newton per square meter.
 - Overall noise level, dB(A) is determined at points of maximum noise level and the values of all mid-band frequencies are basis A scale readings.

When the required condition flow is outside the range of 75 to 125% BEP, a part load correction (PLC) must be added to the noise level as follows:

Percent of BEP @ required impeller diameter	PLC in dB
74 to 62 or 126 to 136	+1
61 to 50 or 137 to 150	+2
49 to 38	+3
37 to 25	+4

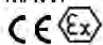
1.10 CE Declaration

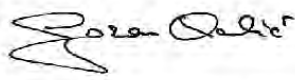
	
<p>Austria , A-2345 Brunn am Geb., Industriestraße B Nr. 6, Tel:++43 2236 31530, Fax: ++43 2236 33430</p>	
<p>DECLARATION OF CONFORMITY</p>	
<p>Section 1.0 MACHINE DESCRIPTION</p> <p>Serial No Equipment/Item Purchase Order Model / Type MAWP  Hydro. Pressure Material Date DD/MM/YY Flow Head Speed Min-1 / RPM Motor kW Hz Volts Amps Connection Country of Destination</p>	
<p>Section 2.0 APPLICABLE DIRECTIVES / REGULATIONS</p> <ul style="list-style-type: none"> - Machinery Directive 2006/42/EC Annex IIA - EMC Directive 2014/30/EU - Explosive Atmospheres Directive 2014/34/EU (ATEX). Only applicable when the  marking appears in section 1.0 Equipment without the  marking must not be used in potentially explosive atmospheres. - Notified Body holding the ATEX Technical Dossier - SIRA (518) Eccleston, ChesterCH4 9JN, United Kingdom 	
<p>Section 3.0 APPLICABLE STANDARDS / SPECIFICATIONS</p> <ul style="list-style-type: none"> - EN809:1998+A1:2009, EN953:1997+A1:2009, ISO 13857:2008, ISO 12100:2010 - EN13463-1:2009, EN13463-5:2011, EN13463-6:2005 - API 610 8th, 9th, 10th or 11th ed. as applicable - API 682 1st, 2nd or 3rd ed. as applicable 	
<p>Section 4.0 DECLARATION</p> <p>We, Flowserve (Austria) GmbH, at the above address, declare that under our sole responsibility for the supply of the machinery defined in SECTION 1.0 above, the said machinery complies with all the applicable Directives and Regulations set out in SECTION 2.0 above and with all the essential health and safety requirements applying to it when installed, operated and maintained in accordance with the applicable User Instruction manual(s).</p> <div style="text-align: center; margin-top: 20px;">  </div> <div style="display: flex; justify-content: space-between; margin-top: 10px;"> <div style="text-align: center;"> <p>Signed: Dipl.Ing.Goran Rakic Authorised Techn.Manager</p> </div> <div style="text-align: right;"> <p>Date: 03.05.2016</p> </div> </div>	

2.0 TRANSPORT AND STORAGE

2.1 Consignment receipt and unpacking

Immediately after receipt of the equipment it must be checked against the delivery and shipping documents for its completeness and that there has been no damage in transportation.

Any shortage and or damage must be reported immediately to Flowserve and received in writing within one month of receipt of the equipment. Later claims cannot be accepted.

Check any crates, boxes and wrappings for any accessories or spare parts, which may be packed separately with the equipment or attached to side walls of the box or equipment.

Each product has a unique serial number. Check that this number corresponds with that advised and always quote this number in correspondence as well as when ordering spare parts or further accessories.

2.2 Handling

Boxes, crates, pallets or cartons may be unloaded using fork lift vehicles or slings dependent on their size and construction.

2.3 Lifting



To avoid distortion, the pump unit should be lifted as shown.

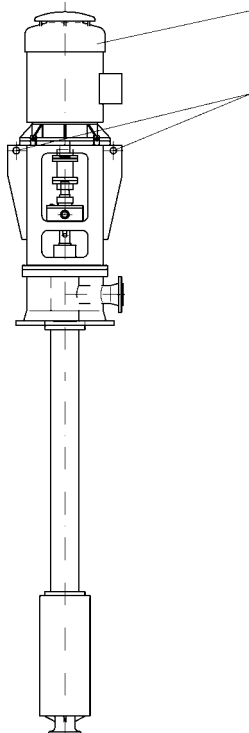

For lifting the driver refer to the dimension drawing of driver

2 holes Ø 45mm (1.77 in.) for lifting the pump without driver

Depended on the pump size the pump unit is packed separately from the driver.



A crane must be used for all pump sets in excess of 25 kg (55 lb). Fully trained personnel must carry out lifting, in accordance with local regulations. The driver and pump

weights are recorded on their respective nameplates.

Note:

In some cases the pumps are not complete assembled (refer to section 4, *Installation*).

2.4 Storage

If the pump will not be put immediately into service, it should be stored in a dry room. To avoid any damage during the storage period, the influence of any low or high frequency vibration must be totally inhibited. If the pump is delivered sealed in a plastic-wrapper, it is of max. importance to avoid any damage of that wrapper, because this will protect the pump against humidity. Therefore it must be checked if this wrapper has become cracked and if so, the wrapper must be renewed. If a vertical pump will be stored in horizontal position, be sure to support the pump sufficiently to avoid any deformation or bending of the pump. To avoid the presence of dust and humidity on the driver, it shall also be wrapped in the same way.

2.4.1 Long period storage

If the pump is delivered in a plastic bag, the preservations stands up for one year. If the storage period exceeds this time, the preservation must be checked and renewed. Also the air tight plastic bag must be changed. Moreover we recommend to order a Flowserve Service Engineer for checking the pump before the first start up.

2.5 Recycling and end of product life

At the end of the service life of the product or its parts, the relevant materials and parts should be recycled or disposed of using an environmentally acceptable method and local regulations. If the product contains substances, which are harmful to the environment, these should be removed and disposed of in accordance with current regulations. This also includes the liquids and or gases in the "seal system" or other utilities.



Make sure that hazardous substances are disposed of safety and that the correct personal protective equipment is used. The safety specifications must be in accordance with the current regulations at all times.

3.0 DESCRIPTION

3.1 Configuration

The model WUJ covers the highly engineered specialty end of the Flowserve family of wet pit vertically suspended pumps. The pump line is based on a modular system, thus providing maximum design and operating flexibility. This is combined with specific design features, including stiff shaft construction, a self-contained axial thrust bearing housing and special materials (Superduplex,

Titanium, ..) for various kind of services. Altogether, this makes the WUJ the pump of choice for the most critical applications, like seawater, crude oil, ect..The pump can be manufactured up to a length of 30m (98.4 ft) and is therefore very often used on off shore platforms.

Liquid is surged from pit or a tank and the last stage impeller is discharging the liquid via the column pipes, to the discharge flange. The thrust is balanced by back wearing rings and balancing holes. A vent connection for the suction is optional.



The sense of rotation of the pump is counter clockwise (CCW), looking from the coupling to the shaft end of the pump.

3.2 Nomenclature

Example:

200WUJ-2M-5+I

200	Flow at BEP
WUJ	Pump type - Can WUJ = without Can
2	indicates speed 2–poles 4 = 4-poles
M	indicates hydraulic Medium Head L = Low Head H = High Head R = Radial Flow
5	Number of stages
I	indicates Inducer as option
D	Dummy stage as option
DS	double suction
P	high pressure

3.3 Design of major parts

3.3.1 Motor stool

The motor stool supports the thrust bearing. On top the driver is mounted.

3.3.2 Discharge head

The discharge head has a rectangular baseplate for open pit installations, or a mounting flange according to ISO/ANSI standards for installation on a tank. It consists of discharge nozzle, including all the necessary vent and drain connections. It is a major part of the pump unit, which supports the column pipes with the hydraulics as well as the motor stool and driver.

3.3.3 Hydraulics

3.3.3.1 Radial flow hydraulics

This are ring section type hydraulics. Suction, stage and discharge casing are hold together by strong tie bolts, which allows a very compact and short design. The radial impellers are hydraulically balanced by back wear rings and balancing holes. The diffusers are designed with 7 to 11 vanes to minimize the radial forces at part load operation. All impellers are slipped on the shaft and axially fixed by the impeller nut. The shaft is supported in the suction casing, in every diffuser and in the discharge casing. Optional the hydraulics can be fitted with an inducer for low NPSH requirement.

3.3.3.2 Mixed flow hydraulics

The hydraulics consists of flanged bowls and a suction casing. The impellers are hydraulically balanced by back wear rings and balancing holes. The diffusers are designed with 7 to 11 vanes to minimize the radial forces at part load operation. All impellers are slipped on the shaft and axially fixed by the impeller nut. The shaft is supported in the suction casing and in each bowl. Optional the hydraulics can be fitted with an inducer for low NPSH requirement.

3.3.3.3 10WUJ-2H

The hydraulic consists of bowls, which are pushed together and hold by strong tie bolts. The impellers are secured to the shaft by split rings. Due to the small size, the impellers are only equipped with front wear rings and therefore unbalanced.

Optional the hydraulics can be fitted with an inducer for low NPSH requirement.

3.3.3.4 20WUJ-2L, 45WUJ-2L, 80WUJ-2L

The hydraulics consists of flanged bowls and a suction casing. The impellers are secured to the shaft by split rings. Due to the small size, the impellers are only equipped with front wear rings and therefore unbalanced.

Optional the hydraulics can be fitted with an inducer for low NPSH requirement.

3.4 Performance and operating limits

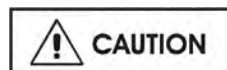

In the interest of operator safety the unit must not be operated above the nameplate conditions. Such operation could result in unit failure causing injury to operating personnel. Consult instruction book for correct operation and maintenance of the pump and its supporting components.

4.0 INSTALLATION



Equipment operated in hazardous locations must comply with the relevant explosion protection regulations, see section 1.6.4, *Products used in potentially explosive atmospheres*.

4.1 Location

The pump should be located to allow room for access, ventilation, maintenance and inspection with ample headroom for lifting and should be as close as practicable to the supply of liquid to be pumped.

Refer to the general arrangement drawing for the pump set.

4.2 Part Assemblies

Usually the pumps are delivered completely mounted and adjusted; also the shaft seal is in the correct position. So no further axial alignment of the rotor is necessary. If drivers and/or seal systems are delivered separately, follow the assembly procedure in section 6.9.

Note:

Axial alignment and rotor setting axial adjustment need to be distinguished. For correct axial adjustment of the rotor refer to 5.3.1 *Adjusting of the rotor*.

4.3 Foundation

The foundation shall be located on a place that allows a minimum of pipe work and that is easily accessible for inspection during operation. According to the environment the foundation may consist of concrete or of steel. It must be rigid and heavy enough to absorb normal vibrations and shocks. The baseplate must be supported on the whole surface. It should be at least 20 - 30 mm (0.8 – 1.2 in) higher than the surrounding to avoid the deposit of dust and humidity.

4.3.1 Vertical alignment

Vertical alignment is done with levelling screws. Use a spirit level for correct horizontal alignment of the baseplate.



The max. vertical misalignment is 0.5 mm/m pump length.

4.3.2 Steel foundation

When the pump unit is mounted directly on structural steel frame, it shall be well supported by constructional beams. It is recommended to check the natural frequency of the steel frame, because it shall not coincide with the pump speed. The baseplate has to be fixed on a flat surface with studs or hex screws, the exact horizontal alignment is very important!

4.3.3 Concrete foundation

A concrete foundation must have an exact horizontal alignment and must be placed on solid ground. First a basic foundation shall be built with square shaped holes for embedding the foundation bolts. After putting the baseplate in the foundation the proper alignment can be obtained by adjusting it with shims. Now insert the foundation bolts and grout the space between the basic foundation and the baseplate with grouting cement (refer to illustration) It is very helpful to use a properly made and stable wooden frame around the baseplate. So the grouting cement will not flow a side. When the grouting is totally set and hardened the foundation bolts shall be tightened in a firm and symmetrical way.

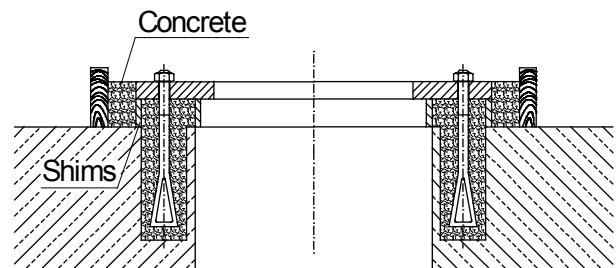

4.3.4 Final assembly for not complete assembled pumps

Pumps exceeding a total length of approximately 6 m (19.7 ft) are delivered in various components and must be assembled on site. The main parts are: hydraulic bowls section - various line shafts and column pipes - discharge head and thrust bearing. To install the pump in the pit, clamps for the column pipes are delivered with the pump.

- 1) Mount the first rising main column pipe [1350.3] and line shaft to the already assembled hydraulic section.

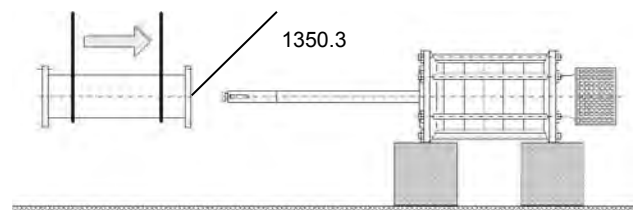

- 2) Mount a clamp to the column pipe. The clamp has lifting lugs, which allow to use a crane for lowering this assembly into the pit (see picture).

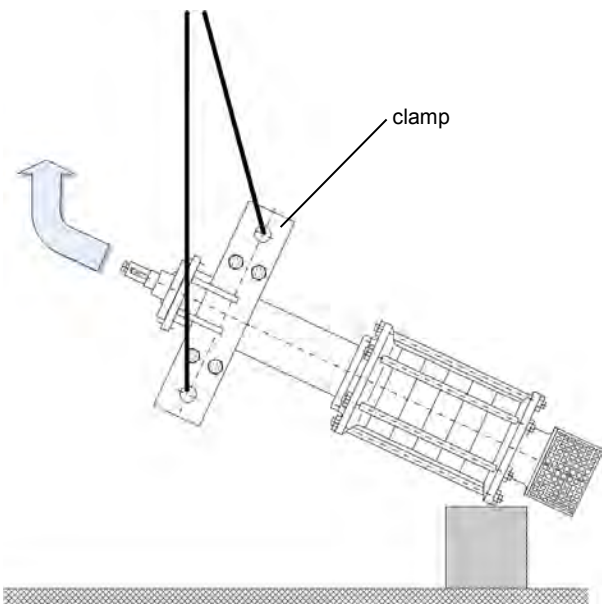

- 3) Connect the next line shaft (refer to section 6, *Maintenance*) and put on the next rising main column pipes [1350.2] (see picture) by using a second clamp.
- 4) Now the assembly consists of the hydraulic section and two column sections. This assembly is taken by a crane using the second clamp.
- 5) Take off the first clamp and lowering down the assembly until the clamp is supported by the wooden frame (see picture).

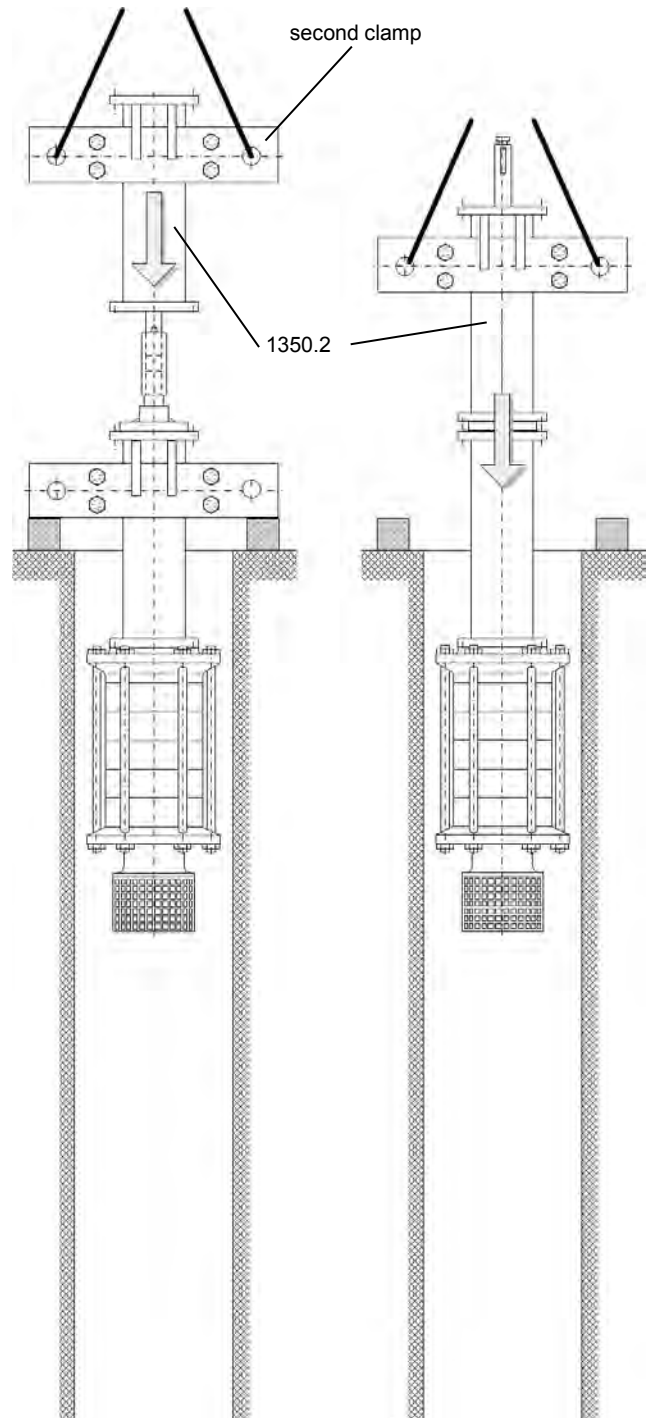

Repeat step 1 to 5 until the pump is completely assembled.

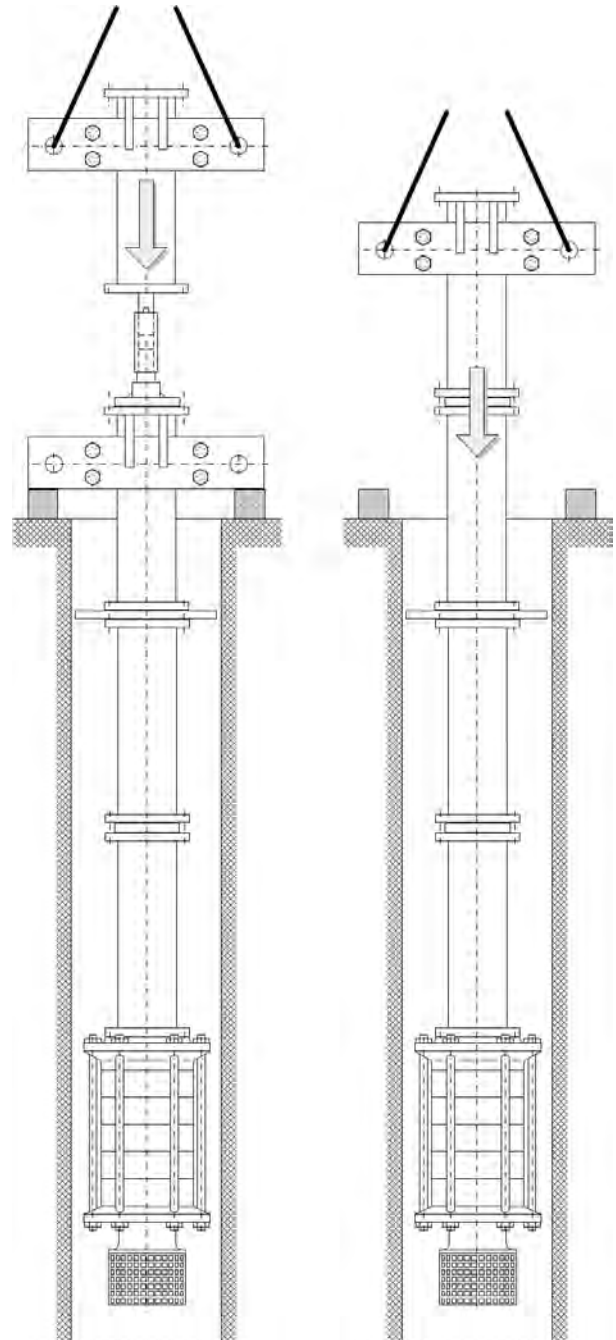
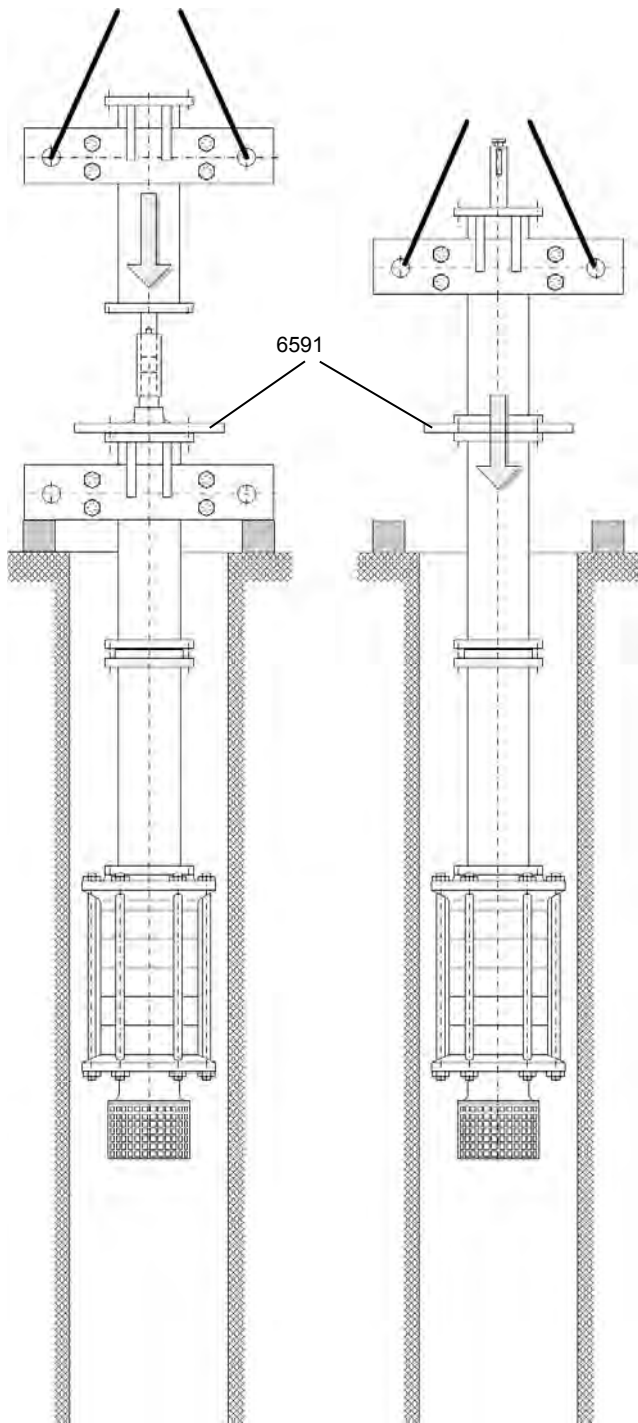

Note: Correct sequence of column pipe:
 Refer to the corresponding assembling drawing where the different lengths of column pipes and the position of the various column pipes are indicated. The first rising main column pipe (above the bowls assembly) [1350.3] has a special flange dimension on the lower end for fitting on the bowls assembly. All following rising main column pipes [1350.2] are of equal design on top and lower end so that these pipes can be used either way. The last one or two rising main column pipes [1350.1] are of different length to reach the required total pump setting. The same special attention must be given to the various intermediate shafts [2120.1] which are all equal between bowl section and last standard rising main

column pipe length [1350.2]. Like the top two rising main column pipes [1350.1] also the corresponding intermediate shafts [2120.2] are different from the standard intermediate shafts [2120.1]. With the top rising main column pipes [1350.1] the top shaft [2130.1] is assembled. Now you can put on the discharge head [1370] and hexagon head bolt [6577.4] it to the top column pipe.

Tight the flange bolts crosswise by using a torque wrench. (For torques refer to section 6, *Maintenance*)

4.4 Initial alignment

The adjustment of motor and pump must be checked (if necessary, make a new adjustment) before first start up of the unit. The motor flange is equipped with adjustment-screws on the motorstand. (Values for adjustment are specified in the coupling instruction manual).

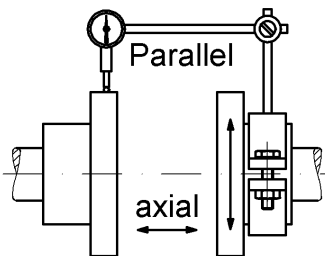

Ensure pump and driver are isolated electrically and the half couplings are disconnected. Align the motor to the pump, not the pump to the motor. Alignment of the motor is achieved by using the adjustment screws.

Note: If the pump is equipped with a hydrodynamic thrust bearing, pump shaft shall be centered in the thrust pot prior to driver alignment (refer to "Pump alignment for hydrodynamic thrust bearings"). Pump shaft has to remain in the centered position until the pump and driver shafts alignment is completed.

4.4.1 Permissible misalignment limits at working temperature

When checking parallel alignment, the total indicator read-out (TIR) shown is twice the value of the actual shaft displacement.

The pump is only pre-aligned! Carefully check and readjust alignment before start of the unit. Take out the spacer of the coupling and check the alignment of shafts end of pump and driver. The maximum parallel offset should not exceed 0.05 mm (0.002 in.) and the axially offset can be ± 2.5 mm (0.10 in.). The coupling spacer gap length shall be ± 0.25 mm (0.01 in.).

For more details refer to the manufacturer's instruction manual of coupling.

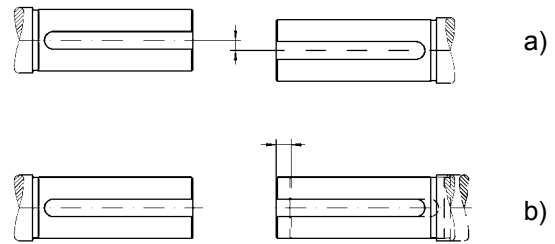

- a) Parallel Offset: The median lines run parallel. The maximum allowable parallel offset depends on the size of coupling and is indicated in the instruction manual of manufacturer of coupling
- b) Axially Offset: Another offset is the displacement of one or both of the shafts. A typical example is thermal expansion.

Note: The DBSE (distance between shaft ends) is shown on the General Arrangement Drawing and is larger than the length of the coupling spacer. This is necessary to compensate all manufacturing tolerances of line shafts and column pipes and to allow correct axial adjustment of the rotor (refer to 5.3.1 *Adjusting of the rotor*).

For installation of the coupling spacer the coupling hub on the pump shaft must be axially moved to match the spacer. This results in an axial clearance "x" between coupling hub and shaft end, which is taken into account by the coupling selection.

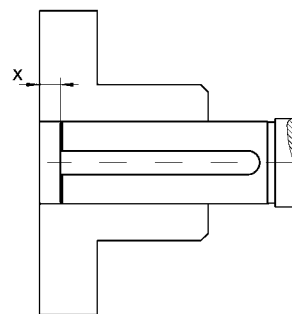

How the alignment of the coupling should be done you can see on the sketches and explanations below!

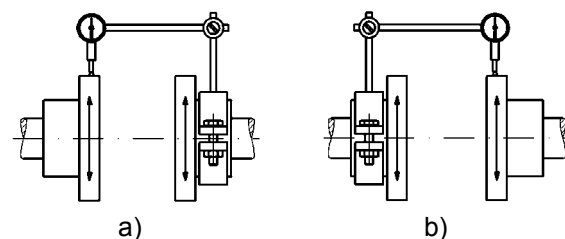

- a) Fix the dial gauge on the driven shaft and check the concentricity by turning of both hubs; correct it if necessary.
- b) Fix the dial gauge on the driving shaft and check the concentricity by turning of both hubs; correct it if necessary.

If the pump is handling hot liquid, the alignment must be rechecked in warm condition of the unit.

4.5 Piping

4.5.1 General

Protective covers are fitted to the pipe connections to prevent foreign particles entering during transportation and installation. Ensure that these covers are removed from the pump before connecting any pipes.

Maximum forces and moments allowed on the pump flanges vary with the pump size and type. To minimize these forces and moments which may cause misalignment, hot bearings, worn couplings, vibration and a possible failure of the pump, the following points shall be strictly followed:

- a) Prevent excessive external pipe load.
- b) Do not connect piping by applying external force (use of wrenches, crane,...). Piping shall be aligned without residual stress.
- c) Do not mount expansion joints so that their force, due to internal pressure, acts on the pump flange.

Fitting an isolator and non-return valve can allow easier maintenance.

A non-return valve shall be located in the discharge pipework to protect the pump from excessive back pressure and hence reverse rotation when the unit is stopped.



If sludge can build up in the sump it is recommended to use a strainer with a maximum opening size of 6 mm (0.024 in.) and a free surface area greater than three times the pump suction area.

Piping for corrosive liquids shall be arranged to allow pump flushing before removal of a unit.

4.5.2 Prelubrication System

A prelubrication system is required if rubber type (Viton) bearing bushings are used. Before the pump is started the prelubrication line must be switched on to flush the column pipes with water. The necessary connection is provided in the discharge head [1370].

Note:

The prelub system is not scope of Flowserve's supply.

4.6 Electrical connections



Electrical connections must be made by a qualified Electrician in accordance with the relevant local national and international regulations.



It is important to be aware of the EUROPEAN DIRECTIVE on hazardous areas where compliance with IEC60079-14 is an additional requirement for making electrical connections.

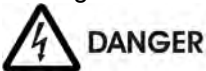

It is important to be aware of the EUROPEAN DIRECTIVE on electromagnetic compatibility when wiring up and installing equipment on site. Attention must be paid to ensure that the techniques used during wiring/installation do not increase electromagnetic emissions or decrease the electromagnetic immunity of the equipment, wiring or any connected devices. If in any doubt contact Flowserve for advice.



The motor must be wired up in accordance with the motor manufacturer's instructions (normally supplied within the terminal box) including any temperature, earth leakage, current and other protective devices as appropriate. The identification nameplate should be checked to ensure the power supply is appropriate.



A device to provide emergency stopping must be fitted.

If not supplied pre-wired to the pump unit the controller/starter electrical details will also be supplied within the controller/starter.

For electrical details on pump sets with controllers see the separate wiring diagram.



See section 5.4, *Direction of rotation* before connecting the motor to the electrical supply.

4.7 Final shaft alignment check

After connecting piping to the pump, rotate the shaft several times by hand to ensure there is no seizure and all parts are free.

Recheck the coupling alignment, as previously described, to ensure no pipe strain. If pipe strain exists, correct piping.

4.8 Protection systems



The following protection systems are recommended particularly if the pump is installed in a hazardous environment or is handling a hazardous liquid. If in doubt consult Flowserve.

If there is any possibility of the system allowing the pump to run against a closed valve or below minimum continuous safe flow a protection device should be installed to ensure the temperature of the liquid does not rise to an unsafe level.

If there are any circumstances in which the system can allow the pump to run dry, or start up empty, a power monitor should be fitted to stop the pump or prevent it from being started. This is particularly relevant if the pump is handling a flammable liquid.

If leakage of product from the pump or its associated sealing system can cause a hazard. It is recommended that an appropriate leakage detection system is installed.

To prevent excessive surface temperatures at bearings it is recommended that temperature or vibration monitoring are carried out.

5.0 COMMISSIONING START-UP, OPERATION AND SHUTDOWN



These operations must be carried out by fully qualified personnel.

5.1 Precommissioning procedure

- a) The bearing housing must be filled with the indicated oil. Check also the oil level.
- b) If required open the prelubrication line (refer to section 4.5.2, *Prelubrication System*), to ensure proper lubrication of the line bearings for start up. It can be closed after start up.
- c) For hot service ($T > 100^{\circ}\text{C}$ (212°F)) the pump shall be preflushed with the pump liquid.
- d) Check the sense of rotation of the pump (Coupling spacer dismantled). Sense of rotation is counter clockwise viewed to the drive end of the pump.
- e) The pump rotor and the shaft seal must be in correct axial position. Mounting plates of mechanical seal must be locked at the seal gland in open position. Drive-collar of the mechanical seal sleeve must be tightened.
- f) Check the readiness of all auxiliary systems (seal sys., lubrication sys.,...) for start up.
- g) All pipe work, including the internal and the auxiliary pipe work, must be connected correctly and must be absolutely tight. Check the tightness of all connections of the auxiliary pipe work. The

suction valve must be open, the discharge valve shall be closed.

- h) Turn the pump by hand, if required with the help of a lever, to check the free rotation of the rotor. The rotor must turn uniformly and noiselessly. Some resistance may be felt due to friction in bearings and seals.
- i) Check the readiness of the driver for start up. Refer to the manual of the driver (preheating for explosion proof E-motor).

5.2 Pump Lubricants

5.2.1 Lubrication

The bearing housing shall be filled with proper lubricating oil prior to start up. If the pump will be started after a longer storage period, the bearing housing should be first flushed and cleaned with gasoline. It is not necessary to remove the preservation oil as this will mix up thoroughly with the lubrication oil.

Lubrication is provided by the pumping effect of the rotating ball bearings. Maintaining the correct oil level (middle of the oil sight glass) ensures that the lower ball bearing is covered with oil.

For recommended lubricating oils refer to the lubrication table 5.2.6

5.2.2 Oil change

After first start up, the oil shall be changed after 200 service hours.

Every further oil change shall take place after about 2000 service hours or at least every 6 month.

5.2.3 Oil level

The correct oil level is in the middle of the oil sight glass and shall be checked when pump is not in operation. Periodically check if the lubricating oil is mixed with any condensed water. Careful opening of the oil drain during a stop of the pump will show any water.

Note:

During operation the level will decrease due to circulation of the oil through the bearings.



A too high oil level will result in higher bearing temperatures and therefore poorer lubrication.

5.2.4 Oil quality

Oil used for lubrication should only be of high quality. The viscosity of the oil at working temperature must be at least 10 cSt. The pouring point of the oil must be in accordance with the lowest expected temperature of the bearing housing during a stop of the pump. For recommended lubricating oils refer to the lubrication table.

Having selected the corresponding oil quality the actual oil temperature at the bearing housing must be checked after two service hours of the pump.

Considering this measured oil temperature the actual viscosity must be determined by using the data sheet of the oil, to verify the minimum required viscosity of 10 cSt. Do not forget, the oil temperature in the bearing itself is about 10 °C (Δ 18 °F) higher than the oil temperature at the bearing housing. On the following table the oil viscosity is given at 40 °C (104 °F). Determining the correct lubricating oil one must take into consideration that all bearings will have higher temperatures during the first 20 service hours. In constant operation the bearing temperature will decrease about 10 °C (50 °F). The oil temperature shall be lower than 85 °C (185 °F) after this running-in time. The bearing outer race temperature should not exceed 95°C (203°F). If the temperature is higher, the reason may be a wrong oil quality, wrong oil level or overload of the pump because of excessive wear.

If the humidity at the site is high, the roller bearings become easily rusty during stand still periods. To avoid that, we recommend to mix the lubricating oil with a corrosion inhibitor contact your lubrication oil supplier for proper additives inhibitors.

5.2.5 Oil quantity

Bearing size is shown on the nameplate of the pump, and with this the correct thrust bearing frame can be selected according to the following table.

Thrust bearing No.	Oil quantity l (Fl.oz.)	Bearing size
0 N	0.5 (16.9)	7210 BECBJ (M)
1 N	1.5 (50.7)	7313 BECBJ (M)
3 N	2 (67.6)	7315 BECBJ (M)
4 N	2.5 (84.5)	7317 BECBJ (M)
5 N	3 (101.4)	7318 BECBJ (M)
6 N	5 (169)	7322 BECBM
7 N	6.5 (219.8)	7326 BCBM
8 N	6.5 (219.8)	7232 BCBM 7330 BCBM

5.2.6 Lubrication Table

Centrifugal Pump Lubrication	Oil	Oil Bath and Purge Oil Mist Lubrication			Pure Oil Mist Lubrication
	Lubrication service	Ball bearing			
	Type	Mineral Oil (Petroleum Based)			Mineral Oil (Petroleum Based)
	Ambient temperature °C (°F)	-20 to 35 (-4 to 95)		35 to 60 (95 to 140)	-5 to 60 (23 to 140)
	Oil temperature range* °C (°F)	-5 to 65 (23 to 149)	up to 85 (up to 185)	up to 100 (up to 212)	15 and above (59 and above)
	Viscosity mm ² /s 40°C [cSt]	32	46	68	100
	First Oil Change	200 hours	200 hours	200 hours	200 hours
	Further Oil Changes	2000 hours or at least every 6 months	2000 hours or at least every 6 months	2000 hours or at least every 6 months	2000 hours or at least every 6 months
	Designation according to DIN51502 ISO VG	32	46	68	100
Oil Companies and Lubricants	BP	BP Energol HL32 BP Energol HLP32	BP Energol HL46 BP Energol HLP46	BP Energol HL68 BP Energol HLP68	-
	CASTROL	Perfecto T32**	Perfecto T46**	Perfecto T68	-
	OMV	OMV turb HTU 32**	OMV turb HTU 46**	OMV turb HTU 68	-
	Aral	Aral Vitam GF 32	Aral Vitam GF 46	Aral Vitam GF 68	-
	Esso	NUTO H32	NUTO H46	NUTO H68	-
	LSC (for oil mist)	LSO 32 Synthetic oil	LSO 46 Synthetic oil	LSO 68 Synthetic oil	LSO 100 Synthetic oil
	Mobil	Mobil Nuto H32 Mobil DTE13M Mobil DTE24	Mobil Nuto H46 Mobil DTE15M Mobil DTE25	Mobil Nuto H68 Mobil DTE16M Mobil DTE26	-
	Shell	Shell Tellus 32 Shell Turbo T32**	Shell Tellus 46 Shell Turbo T46**	Shell Tellus 68 Shell Turbo T68	-
	Texaco	Rando HD 32	Rando HD 46	Rando HD 68	-
	Total	Azolla ZS32	Azolla ZS46	Azolla ZS68	-
	Wintershall (BASF Group)	Wiolan HN32 Wiolan HS32	Wiolan HN46 Wiolan HS46	Wiolan HN68 Wiolan HS68	-

* Note that it normally takes 2 hours for bearing temperature stabilize and the final temperature will depend on the ambient, r/min, pumpage temperature and pump size. Viscosity index shall be at least 95.

** For ambient temperature from -12°C (10 °F) upwards

For temperatures below -5 °C (-23 °F) use lubrication oil class SAE 5W-50 or API-SJ.

	Seal System / Pumped Liquid	Quench-Oil	General Features
Barrier/Buffer Fluid for Mech. Seal	Tandem Seal to -40 °C (-40 °F) Back to back Seal with gascoffer-dam Conventional back to back Seal	- Raffinated Hydraulic Oil - Synthetic Oil - Mixture of water / glykol ATTENTION: <u>Do not use Methanol</u>	appr. 10-15 cSt at 40°C (104 °F) below -40°C (-40 °F) Pourpoint vaporization above 80°C (176 °F)
	Tandem Seal to -60°C (-76 °F)	Ethanol/Propanol	

The sequence of the suppliers of the lubricants does not represent any indication of their superiority.

¹ Viscosity at 40 °C (104 °F) in cSt [mm²/s] DIN 51562

5.2.7 Hydrodynamic thrust bearing lubrication

If the pump is equipped with a hydrodynamic thrust bearing refer to bearing manufacturer's IOM for all data related to the thrust bearing lubrication.

5.2.8 Lubrication

The bearing housing shall be filled with proper lubricating oil prior to start up. If the pump will be started after a longer storage period, the bearing housing should be first flushed and cleaned with gasoline. It is not necessary to remove the preservation oil as this will mix up thoroughly with the lubrication oil.

Lubrication is provided by the pumping effect of the rotating ball bearings. Maintaining the correct oil level (middle of the oil sight glass) ensures that the lower ball bearing is covered with oil.

For recommended lubricating oils refer to the lubrication table 5.2.6

5.2.9 Oil change

After first start up, the oil shall be changed after 200 service hours.

Every further oil change shall take place after about 2000 service hours or at least every 6 month.

To change the oil, use the following procedure:

- a) Remove the reservoir (for some type of oilers you must loose a fixing screw or lock nut, refer to section 5.2.3 Oil level).
- b) Open the oil drain on the bearing housing to remove the oil.
- c) Close the oil drain and fill in Oil through the oiler until the oil level reaches the bottom of the sight glass.
- d) Fill the reservoir and put it quickly to the body of the oiler. Observe the level in the reservoir. It will decrease until the required oil level is reached (middle of the sight glass). Ensure that enough oil remains in the reservoir.
- e) If necessary, the oil level can be adjusted by referring to section 5.2.3 Oil level.

5.2.10 Oil level

The correct oil level is in the middle of the oil sight glass and shall be checked when pump is not in operation. Periodically check if the lubricating oil is mixed with any condensed water. Careful opening of the oil drain during a stop of the pump will show any water.

Note: During operation the level will decrease due to circulation of the oil through the bearings.

A too high oil level will result in higher bearing temperatures and therefore poorer lubrication.

5.2.10.1 Adjusting of TRICO Constant Level Oiler

If the pump is fitted with a Constant Level Oiler type „TRICO“, the correct oil level has to be checked after fitting the pump!

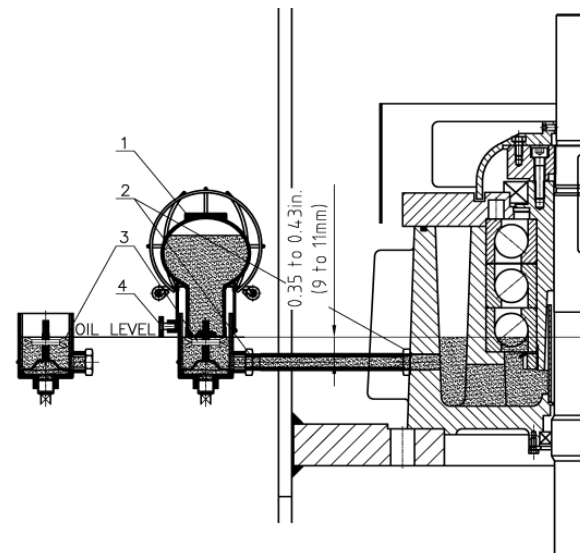
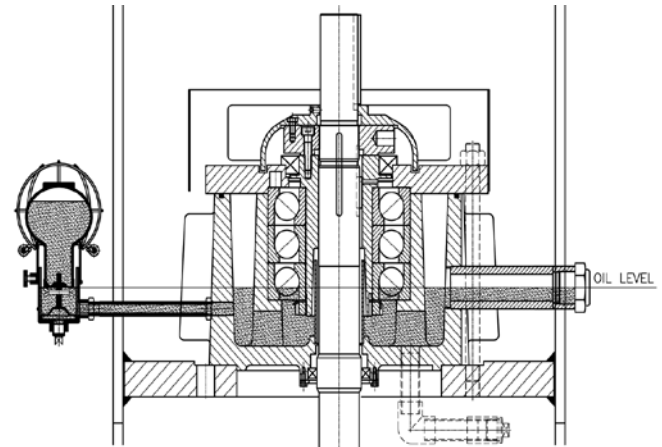

- | | | | |
|---|----------------|---|--------------|
| 1 | Trico-Oiler | 2 | Counter nut |
| 3 | Leveling screw | 4 | Fixing screw |

- a) To check quickly the correct oiler adjustment, loosen the thumb screw and remove the reservoir. Turn the adjusting nut until you reach 0.35 to 0.43 in. (9 to 11mm) distance from the top of the adjusting nut to the centerline of the side port.
- b) Additionally you can check the correct oiler adjustment by an oil sight glass (minimum oil level is the middle of the oil sight glass).
- c) After a correct oiler adjustment, reinstall the reservoir and the oiler body and tighten the thumb screw.

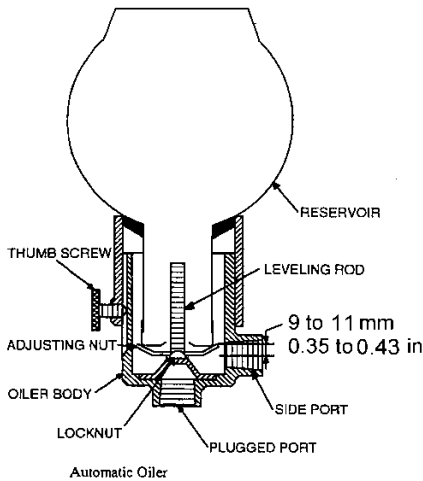

5.2.11 Lubrication

The bearing housing shall be filled with proper lubricating oil prior to start up. If the pump will be started after a longer storage period, the bearing housing should be first flushed and cleaned with gasoline. It is not necessary to remove the preservation oil as this will mix up thoroughly with the lubrication oil.

Lubrication is provided by the pumping effect of the rotating ball bearings. Maintaining the correct oil level (middle of the oil sight glass) ensures that the lower ball bearing is covered with oil.

For recommended lubricating oils refer to the lubrication table 5.2.6

5.2.12 Oil change

After first start up, the oil shall be changed after 200 service hours.

Every further oil change shall take place after about 2000 service hours or at least every 6 month.

To change the oil, use the following procedure:

- a) Remove the reservoir (for some type of oilers you must loose a fixing screw or lock nut, refer to section 5.2.3 *Oil level*).
- b) Open the oil drain on the bearing housing to remove the oil.
- c) Close the oil drain and fill in Oil through the oiler until the oil level reaches the bottom of the sight glass.
- d) Fill the reservoir and put it quickly to the body of the oiler. Observe the level in the reservoir. It will decrease until the required oil level is reached (middle of the sight glass). Ensure that enough oil remains in the reservoir.
- e) If necessary, the oil level can be adjusted by refering to section 5.2.3 *Oil level*.

5.2.13 Oil level

The correct oil level is in the middle of the oil sight glass and shall be checked when pump is not in operation. Periodically check if the lubricating oil is mixed with any condensed water. Careful opening of the oil drain

during a stop of the pump will show any water.

Note:

During operation the level will decrease due to circulation of the oil through the bearings.



A too high oil level will result in higher bearing temperatures and therefore poorer lubrication.

5.2.13.1 Adjusting of WATCHDOG Constant Level Oiler

This design of Watchdog Oiler prevents the flooding of the bearing by means of the positive setting in the Oiler, thus maintaining the correct oil level at all times. When these Oilers are used on Ball or Roller bearings, the installation is the same as described below, excepting that the oil level in the bearing should never cover more than maximum above inside diameter of the outer race at its lowest point.

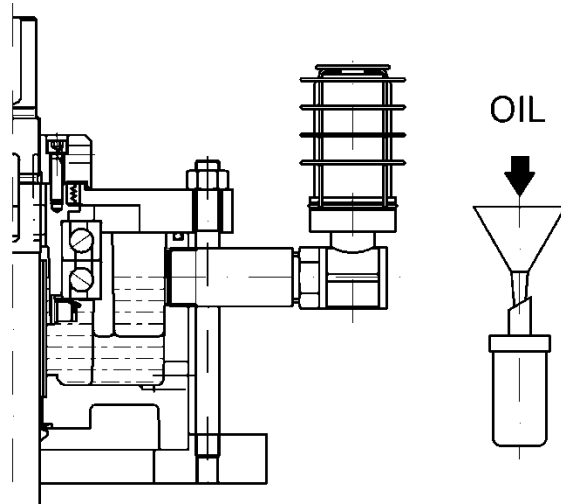

Note:

If the pump is fitted with a Constant Level Oiler type "WATCHDOG", no adjustment of the oil level is possible.

5.2.14 Pure oil mist Lubrication

Pure oil mist system utilize a continuous oil mist flow through the bearing housing to deliver clean oil directly to the bearings and to maintain an outward flow of air from the housing to prevent the ingress of moisture and other corrosive contaminants. If the pump will be started after a longer storage period, the bearing housing should be first flushed and cleaned with gasoline. It is not necessary to remove the preservation oil.

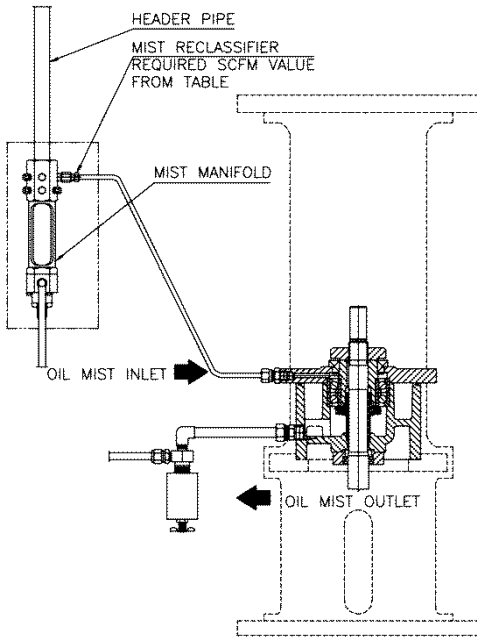

The supplied air must be dry and clean. The cleanness must be $< 5\mu\text{m}$.

The bearing housing requires a minimum SCFM value as follows:

Bearing Frame	Reclassifier at Manifold
0N	1 x 0.18 SCFM
1N	1 x 0.30 SCFM
3N	2 x 0.30 SCFM
4N	2 x 0.30 SCFM
5N	2 x 0.30 SCFM
6N	2 x 0.30 SCFM
7N	2 x 0.45 SCFM
8N	2 x 0.30 SCFM



The pressure in the bearing housing shall be 0,05 bar (0,74 psi) (20 inches of water column). A continuous lubrication should be occur during operation and standby. Pre Lubrication shall be performed at least 1h before first start up.



After start up the bearing temperature must be observed carefully. The temperature at the bearing housing should not exceed 85°C.



Refer to the General Arrangement drawing regarding the connections for the oil mist lubrication.

5.2.15 Oil quality

Oil used for lubrication should only be of high quality. Flowserve recommend that quality synthetic oil are used where ambient temperatures fall below 4°C; the oil used must be paraffin free to prevent plugging of the reclassifier.

Oil with a viscosity class ISO VG100 shall be used, refer also to lubrication table 5.2.6.

5.2.16 Lubrication

The bearing housing shall be filled with proper lubricating oil prior to start up. If the pump will be started after a longer storage period, the bearing housing should be first flushed and cleaned with gasoline. It is not necessary to remove the preservation oil as this will mix up thoroughly with the lubrication oil.

Lubrication is provided by the pumping effect of the rotating ball bearings. Maintaining the correct oil level (middle of the oil sight glass) ensures that the lower ball bearing is covered with oil.

For recommended lubricating oils refer to the lubrication table 5.2.7.

5.2.17 Purge oil mist Lubrication

Purge oil mist system utilize a continuous oil mist flow through the bearing housing to deliver clean oil directly to the bearing housing to maintain an outward flow of air from the housing to prevent the ingress of moisture and other corrosive contaminants.

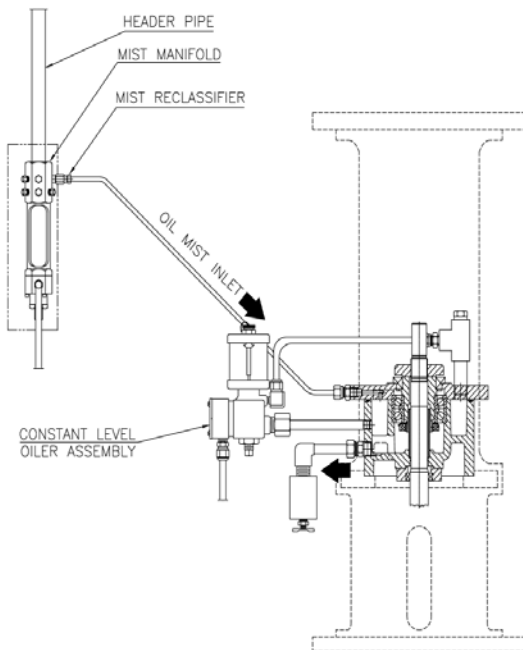

The supplied air must be dry and clean. The cleanness must be < 5µm.

For Purge Oil Mist Lubrication, a Reclassifier with a Value of 0.09 SCFM should be used at the Manifold. The bearing housing is equipped with a constant level oiler with included overflow device. The Overflow connection (3/8" tube) shall be connected to a collection container. Check overflow setting as per Oiler IOM.

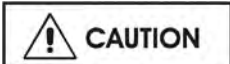

The pressure in the bearing housing shall be 0,05 bar (0,74 psi) (20 inches of water column). A continuous oil mist lubrication should be occur

during operation and stand by.

Note: After start up the bearing temperature must be observed carefully. The temperature at the bearing housing should not exceed 85°C.

Note: Refer to the GA-drawing regarding the connections to the supply systems.

5.2.18 Oil change

After first start up, the oil shall be changed after 200 service hours.

Every further oil change shall take place after about 2000 service hours or at least every 6 month. To change the oil use the following procedure:

- a) Open the oil drain on the bearing housing to remove the oil.
- b) Close the oil drain and fill in Oil through the vent connection on the bearing cover until the oil level reaches the middle of the sight glass.
- c) Fill the reservoir of the constant level oiler.
- d) If necessary, the oil level can be adjusted by referring to section 5.2.4 *Oil level*.

5.2.19 Oil level

The correct oil level is in the middle of the oil sight glass and shall be checked when pump is not in operation. Periodically check if the lubricating oil is mixed with any condensed water. Careful opening of the oil drain during a stop of the pump will show any water.

During operation a small increase of the oil level can occur due to the oil mist supply.

A too high oil level will result in higher bearing temperatures and therefore poorer lubrication.

5.3 Impeller clearance

Correct axial rotor setting is essential for trouble free operation of the pump.

5.3.1 Adjusting of the rotor

- a) Remove coupling spacer, coupling hub on pump shaft and fan [8161] (when delivered).

Note: Use an anaerobic adhesive for securing the socket set screw for reassembly.

- b) Fix the position of the mechanical seal by putting the assembly jigs, mounted on the seal end plate, into the groove in the shaft sleeve.
- c) Open screws from the clamping unit, located on the end of the shaft sleeve (refer to shaft seal drawing).
- d) Loose and remove socket head cap screws [6579.1] from the shaft nut [2910].

- e) Turn shaft nut upside till the rotor moves in the lowest position and cannot turned by hand.
- f) Measure the dimension from the shaft nut to the end of the shaft.
- g) Now lift the rotor by turning the shaft nut in the other direction till it is in the highest position.

Note:

For heavy pumps (rotor weight > 150 kg (331 lb.)) we recommend the following practice. The rotor is already in its lowest position. Screw in an Eyebolt into the thread at the top of the shaft. Use a lever or a crane to lift the shaft (do it slowly, the axial clearance is only a few millimeters).

- h) Measure again the dimension from the shaft nut to the end of the shaft.
- i) Take the mean value of the two dimensions and adjust the rotor to this value by turning the shaft nut.
- j) Fix the shaft nut with the socket head cap screws.
- k) Fix the shaft sleeve with the clamping unit and turn the assembling jigs out of the groove from the shaft sleeve and fix them on the seal end plate.
- l) Check if the shaft can be turned easy by hand
- m) Mount fan (when delivered) coupling hub and spacer again.

Note:

If the pump is fitted with a rigid spacer type coupling ensure that the coupling is completely assembled and all screws are fixed.

CAUTION

For pumps with a setting length above 5 m (16.4 ft) (distance between centerline discharge and pump suction) all the tolerances of the line shafts must be considered. Therefore put rotor to its lowest position. Then lift rotor to its highest position. Now lower the rotor 3 mm (0.12 in.) to its final axial position. 3 mm (0.12 in.) axial setting applies also for rigid spacer type couplings.

Note:

If the pump is delivered disassembled or if the fluid temperature is below -100°C (-148°F) or above 150 °C (302°F), adjusting of the rotor is necessary prior to the first start up. Rotor adjusting is necessary after each pump maintenance.

5.3.2 Adjusting of the rotor for pump type 10 WUJ-2H, 20, 45 & 80 WUJ – 2L

- a) Remove coupling spacer, coupling hub on pump shaft and fan [8161] (when delivered).

Note:

Use an anaerobic adhesive for securing the socket set screw for reassembly.

- b) Fix the position of the mechanical seal by putting the assembly jigs, mounted on the seal end plate, into the groove in the shaft sleeve.
- c) Open screws from the clamping unit, located on the end of the shaft sleeve (refer to shaft seal drawing).
- d) Loose and remove socket head cap screws [6579.1] from the shaft nut [2910].
- e) Turn shaft nut upside till the rotor moves in the lowest position and cannot turned by hand.
- f) Now lift the rotor by turning the shaft nut in the other direction till it is in the highest position.

Note:

For heavy pumps (rotor weight > 150 kg (331 lb.)) we recommend the following practice. The rotor is already in its lowest position. Screw in an Eyebolt into the thread at the top of the shaft. Use a lever or a crane to lift the shaft (do it slowly, the axial clearance is only a few millimeters).

- g) Turn the shaft nut 180° in opposite direction to slip down the shaft 1mm (0.04 in) from its highest position.
- h) Fix the shaft nut with the socket head cap screws.
- i) Fix the shaft sleeve with the clamping unit and turn the assembling jigs out of the groove from the shaft sleeve and fix them on the seal end plate.
- j) Check if the shaft can be turned easy by hand
- k) Mount fan (when delivered) coupling hub and spacer again.

5.4 Direction of rotation

CAUTION

The sense of rotation of the pump is counter clockwise (CCW); looking from the coupling to the shaft end of the pump.



The rotation of the driver shall be checked.

5.5 Guarding

Be sure that the coupling guards are mounted correctly at the thrust motor stool prior to start up.

5.6 Priming and auxiliary supplies

Ensure that the minimum liquid level is maintained.

Note:

The minimum liquid level is shown on the General Arrangement Drawing. Open external flushing line, if provided. (refer to section 4.5.2 *Prelubrication System*. Auxiliary systems, e.g. barrier /buffer fluid systems, cooling circuits, shall be filled according to the user instructions.

5.7 Starting the pump

- a) Start the driver according to the specification. (Refer to driver IOM)

Note: Pumps are usually started against closed discharge valve

- b) Check the discharge and suction pressure gauge to verify the pumps delivered head. Open the discharge valve slowly, until the pump reaches the specified operation point. The pump must operate smoothly, and the vibration must be below 5 mm/s (0.2 in./sec) (API 610 vibration limits).

The discharge valve must be opened within 30 sec. after start up. Longer operation against closed discharge valve will damage the pump. If a minimum flow valve is installed, take pressure gauge readings to verify the correct operation.

Note: If the backpressure of the discharge pipe is sufficient, pumps can be started against open valve.

Ensure that your driver is capable deliver the higher torque required by starting against open valve.

To prevent the pump from reverse rotation after shut down, the installation of a check valve is recommended.

Although the pump is not affected by reverse rotation because of special coupling design, it can be an issue with the driver. Check the discharge and suction pressure gauge to verify the pumps delivered head.

The pump must operate smoothly, and the vibration must be below 5 mm/s (0.2 in./sec) (API 610 vibration limits).

If a minimum flow valve is installed, take pressure gauge readings to verify the correct operation.

- c) Check the pipe system against any leakage.
- d) Check the mechanical seal against any leakage.

Note: Right after start up a minor leakage of the mechanical seal is quite normal. Normally this leakage disappears after few minutes of operation.

5.8 Operation

- a) Verify that the pump is operating within the specified limits, min/max flow, pressure, temperature, vibration, power
- b) The bearing housing temperature shall not exceed 80 °C (176 °F). If higher bearing temperature are observed, check the viscosity grade of the used lubrication oil.

Note: If the pump is equipped with hydrodynamic thrust bearing refer to bearing manufacturer's IOM and to recommendation for maximum bearing temperature.

CAUTION The minimum viscosity is 10 cSt at the expected oil temperature. (Oil temperature = bearing gland temperature + 10 °C (50 °F))

- c) From time to time check the pump shaft seal. Leakage of 5 ml/hour is also with a mechanical shaft seal unavoidable.
- d) Observe the power consumption of the pump to detect excessive wear.

5.8.1 Normal vibration levels, alarm and trip

For guidance, pumps generally fall under a classification for rigid support machines within the International rotating machinery standards and the recommended maximum levels below are based on those standards.

CAUTION Alarm and trip values for installed pumps should be based on the actual measurements (N) taken on the pump in the fully commissioned as new condition.

Regular monitoring of the pump vibration is recommended to show any deterioration in pump or system operating conditions. The vibration is measured adjacent to the pump thrust bearing. For remote installations continuous monitoring and automatic alert and shutdown is recommended.

Vibration velocity – unfiltered mm/sec (in./sec) r.m.s.		
Normal	N	≤ 3.4 (0.14)
Alarm	N x 1.25	≤ 4.25 (0.17)
Shutdown trip	N x 2.0	≤ 6.8 (0.27)

5.9 Stopping and Shutdown

- a) Close the outlet valve, but ensure that the pump runs in this condition for no more than a few seconds.
- b) Stop the pump.
- c) Switch off flushing and/or cooling/ heating liquid supplies at a time appropriate to the process.
- d) For prolonged shut-downs and especially when ambient temperatures are likely to drop below freezing point, the pump and any cooling and flushing arrangements must be drained or otherwise protected.

Note: For automatic start/stop operation of the pump, ensure that all steps described in chapter 5.6, 5.7, 5.8 and 5.9 are implemented in the control logic.

5.10 Hydraulic, mechanical and electrical duty

This product has been supplied to meet the performance specifications of your purchase order, however it is understood that during the life of the product these may change. The following notes will help the user to decide how to evaluate the implications of any change. If in doubt contact your nearest Flowserve office.

5.10.1 Specific gravity (SG)

Pump capacity and total head in meters (feet) do not change with SG, however pressure displayed on a pressure gauge is directly proportional to SG. Power absorbed is also directly proportional to SG. It is therefore important to check that any change in SG will not overload the pump driver or over-pressurize the pump.

5.10.2 Viscosity

For a given flow rate the total head reduces with increased viscosity and increases with reduced viscosity. Also for a given flow rate the power absorbed increases with increased viscosity, and reduces with reduced viscosity. It is important that checks are made with your nearest Flowserve office if changes in viscosity are planned.

5.10.3 Pump speed

Changing pump speed effects flow, total head, power absorbed, NPSHR, noise and vibration. Flow varies in direct proportion to pump speed. Head varies as speed ratio squared. Power varies as speed ratio cubed. If increasing speed it is important therefore to ensure the maximum pump working pressure is not exceeded, the driver is not overloaded, $NPSHA > NPSHR$, and that noise and vibration are within local requirements and regulations.

5.10.4 Net positive suction head (NPSHA)

NPSH available (NPSHA.) is a measure of the energy available in the pumped liquid, above its vapour pressure, at the pump suction branch. NPSH required (NPSHR.) - is a measure of the energy required in the pumped liquid, above its vapour pressure, to prevent the pump from cavitating. It is important that $NPSHA > NPSHR$. The margin between $NPSHA > NPSHR$ should be as large as possible. If any change in NPSHA is proposed, ensure these margins are not significantly eroded. Refer to the pump performance curve to determine exact requirements particularly if flow has changed. If in doubt please consult your nearest Flowserve office for advise and details of the minimum allowable margin for your application.

5.10.5 Pumped flow

Flow must not fall outside the minimum and maximum continuous safe flow shown on the pump performance curve and/or data sheet.

6.0 MAINTENANCE

6.1 General



It is the plant operator's responsibility to ensure that all maintenance, inspection and assembly work is carried out by authorized and qualified personnel who have adequately familiarized themselves with the subject matter by studying this manual in detail. (See also section 1.6.2.)

Any work on the machine must be performed when it is at a standstill. It is imperative that the procedure for shutting down the machine is followed, as described in section 5.9.

On completion of work all guards and safety devices must be re-installed and made operative again.

Before restarting the machine, the relevant instructions listed in section 5, *Commissioning, start up, operation and shut down* must be observed.

Oil and grease leaks may make the ground slippery. Machine maintenance must always begin and finish by cleaning the ground and the exterior of the machine.

If platforms, stairs and guard rails are required for maintenance, they must be placed for easy access to areas where maintenance and inspection are to be carried out. The positioning of these accessories must not limit access or hinder the lifting of the part to be serviced.

When air or compressed inert gas is used in the maintenance process, the operator and anyone in the vicinity must be careful and have the appropriate protection.

Do not spray air or compressed inert gas on skin.

Do not direct an air or gas jet towards other people.

Never use air or compressed inert gas to clean clothes.

Before working on the pump, take measures to prevent an uncontrolled start. Put a warning board on the starting device with the words:

"Machine under repair: do not start".

With electric drive equipment, lock the main switch open and withdraw any fuses. Put a warning board on the fuse box or main switch with the words: **"Machine under repair: do not connect"**.

Never clean equipment with inflammable solvents or carbon tetrachloride. Protect yourself against toxic fumes when using cleaning agents.

6.2 Maintenance schedule



It is recommended that a maintenance plan and schedule is adopted, in line with these User Instructions, to include the following:

- Any auxiliary systems installed must be monitored, if necessary, to ensure they function correctly.
- Gland packings must be adjusted correctly to give visible leakage and concentric alignment of the gland follower to prevent excessive temperature of the packing or follower.
- Check for any leaks from gaskets and seals. The correct functioning of the shaft seal must be checked regularly.
- Check bearing lubricant level, and if the hours run show a lubricant change is required.
- Check that the duty condition is in the safe operating range for the pump.
- Check vibration, noise level and surface temperature at the bearings to confirm satisfactory operation.
- Check dirt and dust is removed from areas around close clearances, bearing housings and motors.
- Check coupling alignment and re-align if necessary.

Our specialist service personnel can help with preventative maintenance records and provide condition monitoring for temperature and vibration to identify the onset of potential problems.

If any problems are found the following sequence of actions should take place:

- Refer to section 8, *Faults; causes and remedies*, for fault diagnosis.
- Ensure equipment complies with the recommendations in this manual.
- Contact Flowserve if the problem persists.

6.2.1 Routine Inspection (daily/weekly)

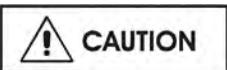

The following checks should be made and the appropriate action taken to remedy any deviations.

- Check operating behaviour; ensure noise, vibration and bearing temperatures are normal.
- Check that there are no abnormal fluid or lubricant leaks (static and dynamic seals) and

that any sealant systems (if fitted) are full and operating normally.

- Check that shaft seal leaks are within acceptable limits.
- Check the level and condition of lubrication oil. On grease lubricated pumps, check running hours since last recharge of grease or complete grease change.
- Check any auxiliary supplies eg. heating/cooling (if fitted) are operating correctly.
- Refer to the manuals of any associated equipment if routine checks needed.

6.2.2 Periodic Inspection (every 6 Month)



- Check foundation bolts for security of attachment and corrosion.
- Check pump operation hours to determine if bearing lubricant shall be changed.
- The coupling should be checked for correct alignment and worn driving elements.



Refer to the manuals of any associated equipment for periodic checks needed.

6.3 Spare parts

6.3.1 Ordering of spares

When ordering spare parts we need the following information:

- pump type and pump size
- serial number of the pump
- number of the required spare parts
- reference number and name of the part as listed in the part list or in the sectional drawing

Example: for Wet pit pump:

10 WUJ-2H, serial number G202222/01
1 piece impeller Pos. 2200.1

The serial number of each pump is indicated on the name plate. If the material should be changed from the original delivered one, additionally indicate the exact material specification. If ordered impellers shall have smaller or larger outer diameter, indicate also with your order. Without a special remark the spare impellers will be delivered with the diameter of the original impellers.

If you need the wear rings oversized or undersized, please indicate, otherwise the wear rings will be delivered with standard size.

To ensure continuous satisfactory operation, replacement parts to the original design specification should be obtained from Flowserve. Any change to the original design specification

(modification or use of a non-standard parts) will invalidate the pump's safety certification.

6.3.2 Storage of spares

Spares should be stored in a clean dry area away from vibration. Inspection and retreatment of metallic surfaces (if necessary) with preservative is recommended at a 6 monthly interval.

6.4 Recommended spares

Part	Spares Recommended						
	Start up			Normal Maintenance			
No.of identical pumps	1 - 3	4 - 6	7+	1 - 3	4 - 6	7 - 9	10+
Element (if unspared)				1	1	1	1
Rotor				1	1	1	1
Case							1
Head (case cover and stuffing box)							1
Motor stool							1
Shaft (w/key)				1	1	2	1
Impeller				1	1	2	3
Wear rings (set)	1	1	1	1	1	2	3
Bearings complete (antifriction,radial)	1	2	3	1	2	3	3
Bearings complete (antifriction,thrust)	1	2	3	1	2	3	3
Bearing pads only (hydrodynamic,thrust)	1	1	1	1	1	1	5
Mechanical seal complete (Cartridge)	1	2	3	1	2	3	3
Shaft sleeve	1	2	3	1	2	3	3
Gaskets, O-rings (set)	1	2	3	1	2	3	3
Bearing bushings and sleeves (set)	1	1	2	1	1	3	3
Stage bushings and sleeves (set)	1	1	2	1	1	3	3

(1) Vital service pumps are generally unspared, partially spared or multistage. When a vital machine is down, production loss or violation of environmental permits results. Element consist of assembled rotor plus stationary hydraulic parts (diffuser(s) or volute(s)).

6.5 Tightening torque & tightening sequence

6.5.1 Tightening torque

Tightening Torque M _A Nm (lbf.ft)										
Size of Screw	Carbon Steel									
	A193 B7M, A320 L7M (NACE) (1)		A193 B7, A320 L7, 8.8, 1.7225 (1)		3.6		4.6		10.9	
	[Nm]	[lbf.ft]	[Nm]	[lbf.ft]	[Nm]	[lbf.ft]	[Nm]	[lbf.ft]	[Nm]	[lbf.ft]
M4	4.2	(3.1)	3	(2.2)	0.8	(0.6)	1.1	(0.8)	4.6	(3.4)
M5	8.3	(6.1)	5.9	(4.4)	1.6	(1.2)	2.2	(1.6)	8.6	(6.3)
M6	14.2	(10.5)	10.1	(7.4)	2.8	(2.1)	3.7	(2.7)	14.9	(11)
M8	35	(26)	24.6	(18.1)	6.8	(5)	9.1	(6.7)	36	(27)
M10	68	(50)	48	(35)	13.7	(10.1)	18.3	(13)	71	(52)
M12	118	(87)	84	(62)	23	(17)	31	(23)	123	(91)
M14	187	(138)	133	(98)	37	(27)	50	(37)	195	(144)
M16	290	(214)	206	(152)	57	(42)	76	(56)	302	(223)
M18	335	(247)	295	(218)	80	(59)	106	(78)	421	(311)
M20	472	(348)	415	(306)	112	(83)	150	(111)	592	(437)
M22	644	(475)	567	(418)	151	(111)	202	(149)	807	(595)
M24	811	(598)	714	(527)	193	(142)	257	(190)	1017	(750)
M27	1193	(880)	1050	(774)	284	(209)	379	(280)	1496	(1103)
M30	1614	(1190)	1420	(1047)	386	(285)	515	(380)	2033	(1500)
M33	2191	(1616)	1928	(1422)	523	(386)	697	(514)	2747	(2026)

M36	2820	(2080)	2482	(1831)	672	(496)	897	(662)	3535	(2607)
M39	3645	(2689)	3208	(2366)	870	(642)	1160	(856)	4569	(3370)
M42	3920	(2891)	3980	(2936)	1146	(845)	1447	(1067)	5670	(4182)
M45	4875	(3596)	4950	(3651)	1425	(1051)	1800	(1328)	7050	(5200)
M48	5899	(4351)	5990	(4418)	1724	(1272)	2178	(1606)	8530	(6292)
M64	14083	(10388)	14300	(10548)	4117	(3037)	5201	(3836)	20370	(15025)
M68	16998	(12538)	17260	(12731)	4969	(3665)	6277	(4630)	24580	(18130)
M76			25230	(18610)	8270	(6100)				

Tightening Torque M _A Nm (lbf.ft)										
Size of Screw	Duplex SS		Austenitic SS					other alloys		
	S32760, S31803, 1.4462		A193 B8M Cl2		A4-70, A2-70		A193 B8/B8M, A193 B8MA (NACE) A2-50, A4-50		N08825	
	[Nm]	[lbf.ft]	[Nm]	[lbf.ft]	[Nm]	[lbf.ft]	[Nm]	[lbf.ft]	[Nm]	[lbf.ft]
M4	2.1	(1.5)	3.2	(2.4)	1.9	(1.4)	0.9	(0.7)	1.1	(0.8)
M5	4.1	(3)	6.4	(4.7)	3.6	(2.7)	1.6	(1.2)	2.2	(1.6)
M6	7.1	(5.2)	10.9	(8)	6.3	(4.6)	2.9	(2.1)	3.7	(2.7)
M8	17	(12.5)	27	(19.9)	15	(11.2)	7.1	(5.2)	9.1	(6.7)
M10	34	(25)	52	(38)	30	(22)	14	(10.3)	18.3	(13)
M12	59	(44)	91	(67)	51	(38)	24	(17.7)	31	(23)
M14	94	(69)	143	(105)	82	(60)	38	(28)	50	(37)
M16	145	(107)	222	(164)	126	(93)	58	(43)	76	(56)
M18	201	(148)	308	(227)	176	(130)	82	(60)	106	(78)
M20	283	(209)	434	(320)	247	(182)	115	(85)	150	(111)
M22	387	(285)	473	(349)	337	(249)	157	(116)	202	(149)
M24	487	(359)	595	(439)	426	(314)	198	(146)	257	(190)
M27	716	(528)	716	(528)	602	(444)	292	(215)	379	(280)
M30	968	(714)	968	(714)	817	(603)	397	(293)	515	(380)
M33	1315	(970)	1008	(744)	1112	(820)	536	(395)	697	(514)
M36	1692	(1248)	1297	(957)	1428	(1053)	690	(509)	897	(662)
M39	2187	(1613)			1849	(1364)	890	(656)	1160	(856)
M42	2714	(2002)			2287	(1687)	1067	(787)	1447	(1067)
M45	3375	(2489)							1800	(1328)
M48	4084	(3012)							2178	(1606)
M64	9750	(7192)							5201	(3836)
M68	11768	(8680)							6277	(4630)
M76										

Above mentioned torques are for all screwed unions, which works under dynamical load. For all other connections you can use a corresponding smaller torque.

Note:

Exceptions have to be taken for the following position numbers:

PN 6571: for tie bolts made of material marked with (1) the torque value has to be reduced by 50%.

PN 6572.4: for all material classes the torque value has to be reduced by 40%.

Anchor bolts are usually made of 4.6 material. Tightening torques indicated in above table shall not be exceeded.

6.5.2 Tightening sequence

Stage 1: Torque the bolts, following the illustrated sequence below, using 30% of the tightening torque indicated in chapter 6.5.1.
 Stage 2: Torque the bolts, following the illustrated sequence below, using 60% of the tightening torque indicated in chapter 6.5.1.
 Stage 3: Torque the bolts, following the illustrated sequence below, using 100% of the tightening torque indicated in chapter 6.5.1.

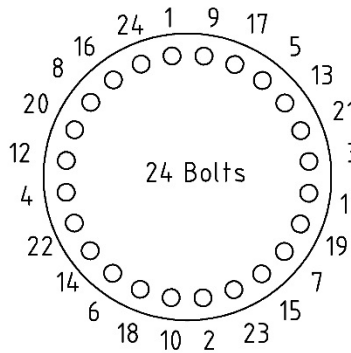
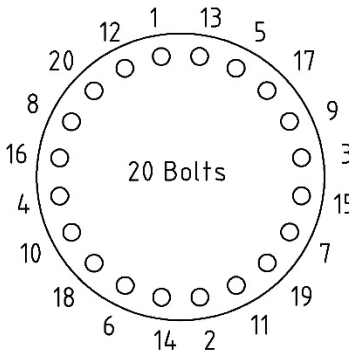
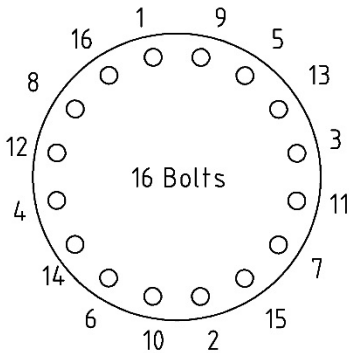
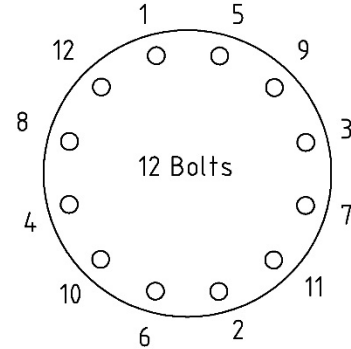
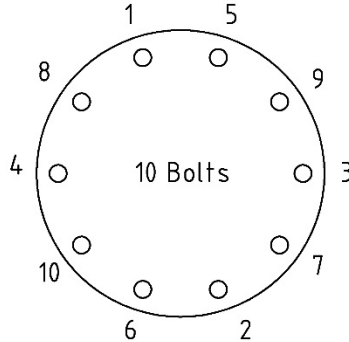
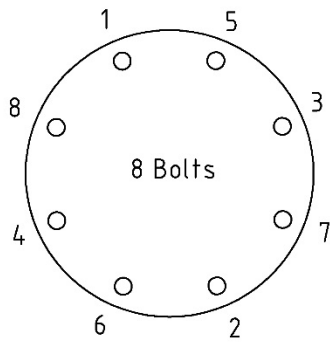

6.6 Setting impeller clearance

For axial rotor setting see section 5 *Commissioning startup, operation and shutdown*.

6.7 Disassembly



Refer to section 1.6, *Safety*, before dismantling the pump.



Before dismantling the pump for overhaul, ensure genuine Flowserve replacement parts are available. Refer to sectional drawings for part numbers and identification.

6.7.1 Dismantling of radial flow impeller pump types

- 1) If the pump is mounted on a tank, ensure that explosive or toxic gases are drained completely. By pumping explosive or toxic media, flush the tank with Nitrogen.

- 2) Uncouple the pump from the motor and remove the motor after disconnecting it from the electrical net.
- 3) Pull off the coupling hub from the pump shaft [2110] and take out the key [6700.1].
- 4) Secure the mechanical seal by putting the tool into the groove of the shaft sleeve. Loose the shrunk ring, and disconnect the seal piping.



Drain the seal system, if applicable.

- 5) Drain the oil from the bearing housing using the plug [6569.1]. Loose the studs [6572.4] and pull out the pump from it's can.
- 6) Loose the socket head cap screw [6579.1] and slip down the rotor by turning the shaft nut [2910] and remove it.

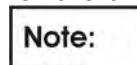

If applicable pull off the fan [8161] after loosing the grub screw [6814.3]. Use an anaerobic adhesive for securing the socket set screw for reassembly.

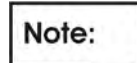

If the pump is equipped with a rigid spacer coupling open the socket head cap screws

[6579.3] move the coupling half [7200], remove the intermediate coupling [7021], coupling ring splits [7415], coupling half [7200] and keys [6700.8].

- 7) Loosen the studs [6572.1], take off the bearing cover [3260.1] and remove key [6700.2].

Note:

Take care of the springs [4260]. Pull off the bearing housing [3200]. Loosen the studs [6572.2] and pull off the mechanical seal cartridge.

Note:

To disassemble only the hydraulic section, start with point 11.

- 8) Open the hexagon head bolt [6577.4] and disconnect the first column pipe from the discharge head [1370].
- 9) Pull out the complete bowl assembly together with shafts and column pipes. Disconnect the first column pipe.
- 10) Open the socket head cap screws [6579.2] and slip upwards the shaft coupling [7020]. Remove the coupling shell split [7240]. Now the shafts are uncoupled and you can proceed the same way with the next column pipe until the bowl assembly can be disconnected from the intermediate or top shaft [2120.1 or 2130.1].
- 11) Remove the grub screw [6814.2] and open the impeller nut [2912]. Pull off the distance sleeve [2460] and take out the key [6700.6].

Note:

If the pump is fitted with an inducer [2215], it has to be pulled off instead of the spacer sleeve.

- 12) Open the tie bolt and hexagon nut [6571, 6581.10] and remove the suction casing [1130] and suction bell [1310].

Note:

Take care of the O-ring [4610.5].

- 13) Pull off the impeller [2200.1] from the pump shaft and remove the key [6700.3].
- 14) Pull off the pump bowl [1170.1], including the diffuser [1410.1]. Now you can take off the interstage sleeve [2410.1] and the next stage impeller [2200.1].

Note:

Take care of the O-ring [4610.5].

- 15) Proceed with the next stage by repeating step 13 and 14, until the hydraulic section is completely dismantled. For disassembly of column sections proceed with step 8 – 10.

6.7.2 Dismantling of mixed flow impeller pump types (Francis type)

- 1) If the pump is mounted on a tank, ensure that explosive or toxic gases are drained completely. By pumping explosive or toxic media, flush the tank with Nitrogen.

- 2) Uncouple the pump from the motor and remove the motor after disconnecting it from the electrical net.
- 3) Pull off the coupling hub from the pump shaft [2110] and take out the key [6700.1].
- 4) Secure the mechanical seal by putting the tool into the groove of the shaft sleeve. Loosen the shrunk ring, and disconnect the seal piping.



Drain the seal system, if applicable.

- 5) Drain the oil from the bearing housing using the plug [6569.1]. Loosen the studs [6572.4] and pull out the pump from its can.
- 6) Loosen the socket head cap screw [6579.1] and slip down the rotor by turning the shaft nut [2910] and remove it.

Note:

If applicable pull off the fan [8161] after loosening the grub screw [6814.3]. Use an anaerobic adhesive for securing the socket set screw for reassembly.

Note:

If the pump is equipped with a rigid spacer coupling open the socket head cap screws [6579.3] move the coupling half [7200], remove the intermediate coupling [7021], coupling ring splits [7415], coupling half [7200] and keys [6700.8].

- 7) Loosen the studs [6572.1], take off the bearing cover [3260.1] and remove key [6700.2].

Note:

Take care of the coupling shell splits [7240]. Pull off the bearing housing [3200]. Loosen the studs [6572.2] and pull off the mechanical seal cartridge.

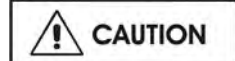

To disassemble only the hydraulic section start with point 11.

Note:

If the pump is fitted with double suction impeller steps 16) till 19) have to be followed first.

- 8) Open the hexagon head bolts [6577.4] and disconnect the first column pipe from the discharge head [1370].
- 9) Pull out the complete bowl assembly together with shafts and column pipes. Disconnect the first column pipe.
- 10) Open the socket head cap screws [6579.2] and slip upwards the shaft coupling [7020]. Remove the coupling shell splits [7240]. Now the shafts are uncoupled and you can proceed the same way with the next column pipe until the bowl assembly can be disconnected from the top or intermediate shaft [2130.1 or 2120.1].
- 11) Remove the grub screw [6814.2] and open the impeller nut [2912]. Pull off the distance sleeve [2460] and take out the key [6700.6].

Note:

If the pump is fitted with an inducer [2215], it has to be pulled off instead of the spacer sleeve.

- 12) Open the hexagon head bolts [6577.7] and pull off the stage casing [1160].

Note:

Take care of the O-ring [4610.5]. Now you can pull off the interstage sleeve [2410.1] from the pump shaft [2110].

- 13) Pull off the impeller [2200.1] from the pump shaft and remove the key [6700.3].
- 14) Open the hexagon head bolts [6577.7] and pull off the pump bowl [1170.1].

Note:

Take care of the O-ring [4610.5]. Pull off the second intermediate bearing sleeve [3400.2] from the pump shaft [2110].

- 15) Proceed with the next stage by repeating step 13 and 14, until the hydraulic section is completely dismantled. For disassembly of column sections proceed with step 8 – 10.
- 16) Remove the grub screw [6814.2] and open the impeller nut [2912.2]. Pull off the distance sleeve [2460] and take out the key [6700.12]. Open the hexagon head bolts [6577.11] and pull off the suction casing [1130].

Note:

Take care of the O-ring [4610.7]. Now you can pull off the bearing sleeve [3400.3] from the pump shaft [2110].

- 17) Pull off the impeller [2200.3] from the pump shaft and remove the key [6700.11].
- 18) Open the hexagon head bolts [6577.7] and pull off the diffuser suction casing [1410].
- 19) Remove the grub screw [6814.2] and open the impeller nut [2912.1].
- 20) Follow the steps 11) to 15) to disassembly the rest of the hydraulic.

6.7.3 Dismantling of 10WUJ-2H

- 1) If the pump is mounted on a tank, ensure that explosive or toxic gases are drained completely. By pumping explosive or toxic media, flush the tank with Nitrogen.
- 2) Uncouple the pump from the motor and remove the motor after disconnecting it from the electrical net.
- 3) Pull off the coupling hub from the pump shaft [2110] and take out the key [6700.1].
- 4) Secure the mechanical seal by putting the tool into the groove of the shaft sleeve. Loose the shrunk ring, and disconnect the seal piping.

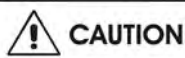

Drain the seal system, if applicable.

- 5) Drain the oil from the bearing housing using the plug [6569.1]. Loose the studs [6572.4] and pull out the pump from it's can.

- 6) Loose the socket head cap screw [6579.1] and slip down the rotor by turning the shaft nut [2910] and remove it.

Note:

If applicable pull off the fan [8161] after loosing the grub screw [6814.3]. Use an anaerobic adhesive for securing the socket set screw for reassembly.

Note:

If the pump is equipped with a rigid spacer coupling open the socket head cap screws [6579.3] move the coupling half [7200], remove the intermediate coupling [7021], coupling ring splits [7415], coupling half [7200] and keys [6700.8].

- 7) Loose the studs [6572.1], take off the bearing cover [3260.1] and remove key [421].

Note:

Take care of the springs [4260]. Pull off the bearing housing [3200]. Loose the studs [6572.2] and pull off the mechanical seal cartridge.

Note:

To disassemble only the hydraulic section start with point 11.

- 8) Open the hexagon head bolts [6577.4] and disconnect the first column pipe from the discharge head [1370].
- 9) Pull out the complete bowl assembly together with shafts and column pipes. Disconnect the first column pipe.
- 10) Open the socket head cap screws [6579.2] and slip upwards the shaft coupling [7020]. Remove the coupling shell splits [7240]. Now the shafts are uncoupled and you can proceed the same way with the next column pipe until the bowl assembly can be disconnected from the top or intermediate shaft [2130.1 or 2120.1].
- 11) Open the tie bolt and hexagon nut [6571, 6581.10] and remove the suction casing [1130].
- 12) Remove the circlip [6544.2] and pull off the impeller [2200.1].

Note:

If the pump is fitted with an inducer [2215], it has to be pulled off instead of the spacer sleeve.

- 13) Remove now the key [6700.3] and the next retaining ring.

Note:

Take care of the O-ring [4610.5]. Pull off the pump bowl [1170.1], so you have access to the next stage impeller.

- 15) Repeat step 12, 13 and 14 until you reach the last stage.
- 16) Open the hexagon head bolts [6577.6], which connects the column pipe with the pump bowl [1170.2] and remove it.

Note: Pump bowl [1170.1] can be splitted in the stage casing [1160] and the diffuser [1410.1]. Refer to sectional drawing.

6.7.4 Dismantling of 20, 45 & 80WUJ-2L

- 1) Completely drain the pump by using the drain connection. By pumping explosive or toxic media, flush it with Nitrogen.
- 2) Uncouple the pump from the motor and remove the motor after disconnecting it from the electrical net.
- 3) Pull off the coupling hub from the pump shaft [2110] and take out the key [6700.1].
- 4) Secure the mechanical seal by putting the tool into the groove of the shaft sleeve. Loose the shrunk ring, and disconnect the seal piping.



Drain the seal system, if applicable.

- 5) Drain the oil from the bearing housing using the plug [6569.1]. Loose the studs [6572.4] and pull out the pump from it's can.
- 6) Loose the socket head cap screw [6579.1] and slip down the rotor by turning the shaft nut [2910] and remove it.

Note: If applicable pull off the fan [8161] after loosing the grub screw [6814.3]. Use an anaerobic adhesive for securing the socket set screw for reassembly.

Note: If the pump is equipped with a rigid spacer coupling open the socket head cap screws [6579.3] move the coupling half [7200], remove the intermediate coupling [7021], coupling ring splits [7415], coupling half [7200] and keys [6700.8].

- 7) Loose the studs [6572.1], take off the bearing cover [3260.1] and remove the key [6700.2].

Note: Take care of the springs [4260]. Pull off the bearing housing [3200]. Loose the studs [6572.2] and pull off the mechanical seal cartridge.

Note: To disassemble only the hydraulic section start with point 11.

- 8) Open the hexagon head bolts [6577.4] and disconnect the first column pipe from the discharge head [1370].
- 9) Pull out the complete bowl assembly together with shafts and column pipes. Disconnect the first column pipe.
- 10) Open the socket head cap screws [6579.2] and slip upwards the shaft coupling [7020]. Remove the coupling shell splits [7240]. Now the shafts are uncoupled and you can proceed the same way with the next column pipe until the bowl assembly

can be disconnected from the top or intermediate shaft [2130.1 or 2120.1].

Note: For 20 WU pump the pump shaft [2110] is especially coupled to the first intermediate shaft [2120.2] by a screwed coupling. Unscrew the intermediate shaft [2120.2] from the coupling sleeve [7250]. Now unscrew the coupling sleeve [7250] from the pump shaft [2110].

Note: Both shafts have a left hand thread.
11) Open the hexagon head bolts [6577.7] and pull off the suction casing [1130].

Note: Take care of the O-ring [4610.5].
12) Remove the circlip [6544.2] and pull off the impeller [2200.1].

Note: If the pump is fitted with an inducer [2215], it has to be pulled off instead of the spacer sleeve.

- 13) Remove now the key [67003.3] and the next retaining ring.
- 14) Open the hexagon head bolts [6577.7] and pull off the pump bowl [1170.1], so you have access to the next stage impeller.

Note: Take care of the O-ring [4610.5].
15) Repeat step 12,13 and 14 until you reach the last stage.
16) Open the hexagon head bolts [6577.6], which connects the column pipe with the last pump bowl [1170.2] and remove it. Pull off the second intermediate bearing sleeve [3400.2] from the pump shaft [2110].

6.7.5 Dismantling of the thrust bearing

Thrust bearing No.	Bearing size
0 N	7210 BECBJ (M)
1 N	7313 BECBJ (M)
3 N	7315 BECBJ (M)
4 N	7317 BECBJ (M)
5 N	7318 BECBJ (M)
6 N	7322 BECBM
7 N	7326 BCBM
8 N	7232 BCBM
	7330 BCBM

6.7.5.1 Bearing housing 3N – 8N

- 1) Remove the bearing assembly consisting of the thrust ball bearing [3013.1], bearing adaptor sleeve [2471], spacer ring [2510] and the bearing lock nut [3712] as a cartridge.

- Open the bearing lock nut [3712] and pull off the thrust ball bearing [3013.1]

6.7.5.2 Bearing housing 0N – 1N

- Remove the bearing assembly consisting of the thrust ball bearing [3013.1], bearing adaptor sleeve [2471] and the bearing lock nut [3712] as a cartridge.
- Open the bearing lock nut [3712] and pull off the thrust ball bearing [3013.1].

Note: For the hydrodynamic thrust bearing dismantling, refer to bearing manufacturer’s IOM.

6.8 Examination of parts

- Check the intermediate bearing sleeves and bushings against any wear. The diametrical clearance between sleeves and bushings must not exceed twice the value in new condition.
- Check the casing wear ring and the impeller wear ring against any wear. The diametrical clearance between the rings must not exceed twice the value in new condition.
- Check all parts against corrosion and erosion.
- Carefully check the coupling against any wear.
- Rotate the angular contact bearing by hand, to check against abnormal sound. Check the bearing cages against any wear and the outer and inner race against running marks. Check the runout of the shafts. TIR (Total Indicated Runout) shall not exceed 0.04 mm/m (0.0005 in./ft) of length. TIR shall not exceed 0.08 mm (0.003 in.) over total shaft length.

Pump size	Wear ring diameter mm (in)	Radial clearances mm (in)
10 WU-2H	64 (2.5)	0.3 - 0.5 (0.012-0.020)
20 WU-2L	64 (2.5)	0.3 - 0.5 (0.012-0.020)
20 WU-2R	112 (4.4)	0.4 - 0.6 (0.016-0.024)
25 WU-2R	115 (4.5)	0.4 - 0.6 (0.016-0.024)
30 WU-2R	112 (4.4)	0.4 - 0.6 (0.016-0.024)
35 WU-2R	112 (4.4)	0.4 - 0.6 (0.016-0.024)
40 WU-2H	95 (3.7)	0.4 - 0.6 (0.016-0.024)
45 WU-2L	87 (3.4)	0.3 - 0.5 (0.012-0.020)
45 WU-2R	112 (4.4)	0.4 - 0.6 (0.016-0.024)
50 WU-2R	112 (4.4)	0.4 - 0.6 (0.016-0.024)
50 WU-2M	85 (3.3)	0.4 - 0.6 (0.016-0.024)
50 WU-2H	140 (5.5)	0.5 - 0.7 (0.020-0.028)
60 WU-2M	85(3.3)	0.4 - 0.6 (0.016-0.024)
60 WU-2R	112 (4.4)	0.4 - 0.6 (0.016-0.024)
65 WU-2R	148 (5.8)	0.5 - 0.7 (0.020-0.028)
80 WU-2L	103 (4.1)	0.4 - 0.6 (0.016-0.024)
80 WU-2H	148 (5.8)	0.5 - 0.7 (0.020-0.028)
90 WU-2R	148 (5.8)	0.5 - 0.7 (0.020-0.028)
100 WU-2R	148 (5.8)	0.5 - 0.7 (0.020-0.028)
100 WU-2M	120 (4.7)	0.5 - 0.7 (0.020-0.028)
125 WU-2L	120 (4.7)	0.5 - 0.7 (0.020-0.028)
150 WU-2R	169 (6.7)	0.5 - 0.7 (0.020-0.028)
150 WU-2M	125 (4.9)	0.5 - 0.7 (0.020-0.028)
180 WU-2L	135/171(5.3/6.7)	0.5 - 0.7 (0.020-0.028)
200 WU-2M	160 (6.3)	0.5 - 0.7 (0.020-0.028)
200 WU-2L	160 (6.3)	0.5 - 0.7 (0.020-0.028)
200 WU-2R	169 (6.7)	0.5 - 0.7 (0.020-0.028)

200 WU-2H	140/165(5.5/6.5)	0.5 - 0.7 (0.020-0.028)
200 WU-4M	180 (7.1)	0.5 - 0.7 (0.020-0.028)
250 WU-4H	200 (7.9)	0.6 - 0.8 (0.024-0.032)
275 WU-2M	160 (6.3)	0.5 - 0.7 (0.020-0.028)
300 WU-2R	183 (7.2)	0.5 - 0.7 (0.020-0.028)
300 WU-4H	230(9.1)	0.6 - 0.8 (0.024-0.032)
300 WU-4M	190/230(7.5/9.1)	0.5 - 0.7 / 0.6 - 0.8 (0.020-0.028 / 0.024-0.032)
300 WU-2L	160/190(6.3/7.5)	0.5 - 0.7 (0.020-0.028)
400 WU-4R	236 (9.3)	0.6 - 0.8 (0.024-0.032)
400 WU-4M	240 (9.5)	0.6 - 0.8 (0.024-0.032)
400 WU-4H	240 (9.5)	0.6 - 0.8 (0.024-0.032)
450 WU-2R	183 (7.2)	0.5 - 0.7 (0.020-0.028)
500 WU-2L	191 (7.5)	0.5 - 0.7 (0.020-0.028)
600 WU-4M	265 (10.4)	0.6 - 0.8 (0.024-0.032)
650 WU-2L	190/230(7.5/9.1)	0.5 - 0.7 / 0.6 - 0.8 (0.020-0.028 / 0.024-0.032)
700 WU-4H	265 (10.4)	0.6 - 0.8 (0.024-0.032)
800 WU-4M	300 (11.8)	0.6 - 0.8 (0.024-0.032)
900 WU-4M	265 (10.4)	0.6 - 0.8 (0.024-0.032)
900 WU-4H	300 (11.8)	0.6 - 0.8 (0.024-0.032)
1000 WU-4H	300 (11.8)	0.6 - 0.8 (0.024-0.032)
1200 WU-4H	330 (13.0)	0.7 - 0.9 (0.028-0.035)
1200 WU-4L	330 (13.0)	0.7 - 0.9 (0.028-0.035)
1400 WU-4M	354 (13.9)	1 - 1.2 (0.039-0.047)
1500 WU-4L	339 (13.4)	0.7 - 0.9 (0.028-0.035)
1600 WU-4M	339 (13.4)	0.7 - 0.9 (0.028-0.035)
2000 WU-4L	360 (14.2)	1 - 1.2 (0.039-0.047)
2000 WU-4M	360 (14.2)	1 - 1.2 (0.039-0.047)
2250 WU-4L	388 (15.3)	1 - 1.2 (0.039-0.047)

Bearing Sleeve Outside diameter mm (in.)	Pipe Bearing Housing Bushing Inner diameter mm (in.)	Radial clearance mm (in.)
31.9 (1.24)	32 (1.25)	0.10±0.12 (0.0039±0.0047)
51.9 (2.02)	52 (2.03)	0.10±0.12 (0.0039±0.0047)
59.9 (2.34)	60 (2.34)	0.11±0.13 (0.0043±0.0051)
71.9 (2.80)	72 (2.80)	0.11±0.13 (0.0043±0.0051)
109.9 (4.29)	110 (4.29)	0.12±0.15 (0.0047±0.0059)
119.9 (4.68)	120 (4.68)	0.12±0.15 (0.0047±0.0059)

6.9 Assembly

To assemble the pump consult the sectional drawings.

Ensure threads, gasket and O-ring mating faces are clean. Apply thread sealant to non-face sealing pipe thread fittings.

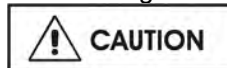

After complete assembly with discharge head and bearing housing the rotor must be lifted!, see section 5 .3 *Impeller clearance*

6.9.1 Assembly of radial flow impeller pump types

Assembly is done preferably in vertical position.

- Put the last stage diffuser [1410.2] into the discharge casing [1140]. Insert the O-ring [4610.5]. Repeat this with all the stage casings [1160], diffusers [1410.1] and O-rings [4610.5].

- 2) Put the discharge casing [1140] over the pump shaft [2110].
- 3) Put in the key [6700.3] in the keyway and slip on the interstage sleeve [2410.2], the last stage impeller [2200.1] and the interstage sleeve [2410.1] to the shaft.
- 4) Put on the next stage casing assembly. Put the key [6700.3] in the keyway and slip on the impeller [2200.1] and the interstage sleeve [2410.1] to the shaft.
- 5) Repeat step 4 until you reach the first stage. After slipping on the first stage impeller [2200.2] and the interstage sleeve [2410.2] you can put on the suction casing [1130].
- 6) Fix the hydraulic assembly by tightening the tie bolts [6571].

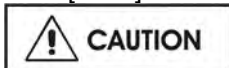

This must be done crosswise with required torques. (refer to section 6, *Maintenance*)

- 7) Put on the distance sleeve [2460], or inducer [2215] and secure the assembly by tightening the impeller nut [2912] just by hand.
- 8) Loose the impeller nut [2912] to the next location for securing it with a grub screw [6814.2].
- 9) For further pump assembly follow reverse disassembly procedure.

6.9.2 Assembly of mixed flow impeller pump types (Francis type)

Assembly is done preferably in vertical position.

- 1) Put the interstage sleeve [2410.3] and the last stage casing over the pump shaft [2110], and slip on the impeller [2200.1]. After putting the O-ring [4610.5] to the next pump bowl [1170.1], slip it on to the last pump bowl [1170.2] and tight the hexagon head bolts [6577.7].
- 2) Slip on the interstage sleeve [2410.1]. Put in the key [6700.3] and slip on the impeller [2200.1].
- 3) Repeat step 1 and 2 until you have mounted the first stage impeller. If the pump is fitted with double suction impeller, move directly to step 8) and follow procedure until step 15).
- 4) Slip on the interstage sleeve [2410.1] and put on the suction casing [1130] including the O-ring [4610.5]. Tight the hexagon head bolts [6577.7].
- 5) Put on the distance sleeve [2460] or inducer [2215] and secure the assembly by tightening the impeller nut [2912] just by hand.
- 6) Loose the impeller nut [2912] to the next location for securing it with a grub screw [6814.2].
- 7) For further pump assembly follow reverse disassembly procedure.
- 8) Secure the assembly by tightening the impeller nut [2912.1] just by hand.
- 9) Loose the impeller nut [2912.1] to the next location for securing it with a grub screw [6814.2].
- 10) Put the bearing sleeve [3400.5] over the pump shaft [2110]. Place the o-ring [4610.5] on the diffuser suction casing [1410] and put them

together over the pump shaft [2110]. Tighten the hexagonal head bolts [6577.7].

- 11) Put in the key [6700.1] and slip on the impeller [2200.3] over the pump shaft [2110].
- 12) Put the bearing sleeve [3400.3] on the pump shaft [2110] and assemble the suction casing [1130] including the o-ring [4610.7]. Tighten the hexagonal head bolts [6577.11].
- 13) Put the key [6700.12] on the pump shaft [2110]. Put on the distance sleeve [2460] and secure the assembly by tightening the impeller nut [2912.2] just by hand.
- 14) Loose the impeller nut [2912.2] to the next location for securing it with a grub screw [6814.2].
- 15) For further pump assembly follow reverse disassembly procedure.

6.9.3 Assembly of 10WUJ-2H

Assembly is done preferably in vertical position.

- 1) Put the last stage casing over the pump shaft [2110]. After putting the O-ring [4610.5] to the next pump bowl [1170.1], slip it on to the pump bowl [1170.2].
- 2) Put the circlip [6544.2] and the key [6700.3] on to the shaft and slip on the impeller [2200.1].
- 3) Secure the impeller with the retaining ring and put on the next pump bowl [1170.1] including an O-ring [4610.5].
- 4) Repeat step 2 and 3 until you have mounted the first stage impeller.
- 5) Put on the suction casing [1130] including the O-ring [4610.5] and tighten the tie bolt and hexagon nut [6571, 6581.10].
- 6) For further pump assembly follow reverse disassembly procedure.

Note:

Pump bowl [1170.1] can be splitted in the stage casing [1160] and the diffuser [1410.1]. Refer to sectional drawing.

6.9.4 Assembly of 20, 45 & 80WUJ-2L

Assembly is done preferably in vertical position.

- 1) Put the last stage casing over the pump shaft [2110]. After putting the O-ring [4610.5] to the next pump bowl [1170.1], slip it on to the last pump bowl [1170.1] and tight the hexagon head bolts [6577.7].
- 2) Put the circlip [6544.2] and the key [6700.3] on to the shaft and slip on the impeller [2200.1].
- 3) Secure the impeller with the retaining ring and put on the next pump bowl [1170.1] including an O-ring [4610.5].
- 4) Repeat step 2 and 3 until you have mounted the first stage impeller.
- 5) Put on the suction bell [1310] including the O-ring [4610.5] and tighten the hexagon head bolts [6577.7].
- 6) For further pump assembly follow reverse disassembly procedure.

Note:

For 20 WU pumps consider the screwed coupling of the pump shaft [2110] to the last intermediate shaft [2120.2]. Screw the coupling sleeve [7250] to the pump shaft [2110] until the shaft end appears in the bore of the sleeve. Now screw the intermediate shaft [2120.1] into the intermediate shaft [2120.2] until it matches the end of the pump shaft [2110]. The coupling sleeve [7250] has a tolerance fit on both shafts to ensure proper alignment. Consider the left hand thread and use Loctite 243 to secure the threaded connection.



CAUTION Due to the threaded coupling the 20 WU pump must not turn in reverse direction.

6.9.5 Assembly of the thrust bearing

Thrust bearing No.	Bearing size
0 N	7210 BECBJ (M)
1 N	7313 BECBJ (M)
3 N	7315 BECBJ (M)
4 N	7317 BECBJ (M)
5 N	7318 BECBJ (M)
6 N	7322 BECBM
7 N	7326 BCBM
8 N	7232 BCBM 7330 BCBM

6.9.5.1 Bearing housing 3N – 8N

- 1) Heat up the first angular contact bearing, and put it on the bearing adaptor sleeve [2471] as shown in the section drawing.
- 2) Install the spacer ring [2510]. Warm up the other two bearings and install it according to the section drawing. Put on the lockwasher [6541] for bearing nut and the bearing lock nut [3712]. After tightening secure the bearing lock nut [3712] with the lockwasher [6541] for bearing nut.

6.9.5.2 Bearing housing 0N – 1N

- 1) Heat up the two bearings and install it according to the section drawing.
- 2) Put on the lockwasher [6541] for bearing nut and the bearing lock nut [3712]. After tightening secure the bearing lock nut [3712] with the lockwasher [6541] for bearing nut.

Note:

For the hydrodynamic thrust bearing assembly refer to bearing manufacturer’s IOM.

7.0 AUXILIARIES

Note:

For additional accessories refer to separate Instrumentation manuals.

7.1 Seal and seal systems

7.1.1 Single Mechanical Seal with API–Plan 23+61

Note:

Refer to mechanical seal drawing and auxiliary piping drawing. The pump is equipped with a single mechanical seal. The cartridge design allows to change the mechanical seal without taking it apart.

Actions before first start up:

The pump will be delivered with correct vertical adjustment of the rotor.

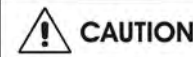

CAUTION Try to turn the rotor by hand. If the rotor cannot be turned readjust it following procedure in section 5.3.1 *Adjusting of the rotor*. The mechanical seal requires no adjustment anymore. Check if the mounting plates are already swung out.

Actions after start up:

Check all connections to the seal gland and the mechanical seal itself against leakage. It is usual that at the seal faces a small leakage occurs after start up, which decreases with the time of operation and should stop after the seal is run in. Check the temperature of the seal gland. A slight increase of temperature may be observed during the run in period. The mechanical seal is flushed by an API Plan 23 and the temperature at the seal gland should be below the pumped liquid temperature (refer to mechanical seal drawing for temperature limit).

Plan 23 is the plan of choice for all hot water services, and it is also desirable in many hydrocarbon and chemical services where it is necessary to cool the fluid establish the required margin between fluid vapour pressure (at the seal chamber temperature) and seal chamber pressure. In a Plan 23, the cooler only removes seal face-generated heat plus heat soak from the process. The seal chamber is isolated by a pump throat bushing with a bypass to suction.

API Plan 61 has tapped and plugged connections for the purchaser’s use. Typically this plan is used when the purchaser is to provide fluid (such as steam, gas, or water) to an external sealing device.



CAUTION Refer to the GA - drawing for the required quench medium, pressure and flow.

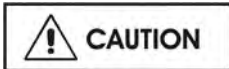

Disassembly of the seal cartridge is only allowed by authorized personal. Contact Flowserve for any service of the mechanical seal. We recommend to have a spare cartridge seal on stock for easy replacement.

7.1.2 Dual Mechanical Seal unpressurized with API-Plan 13+72+76

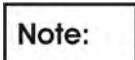

Refer to mechanical seal drawing and auxiliary piping drawing. The pump is equipped with a dual mechanical seal. The cartridge design allows to change the mechanical seal without taking it apart.

The seal cartridge consists of a contacting wet inner seal and a dry containment seal. A buffer gas is used to sweep inner seal leakage away from the outer seal into a collection system and/or provide dilution of the leakage, so that emissions from the containment seal are reduced.

The plan 72 system is intended to function as follows: The barrier gas first flows through an isolation block valve and check valve provided by the purchaser. It then enters a system, usually mounted on a plate or panel, provided by the seal vendor. An inlet block valve on the panel is followed by a 10 µm (0.0004 in.) filter coalescer (if specified) to remove any particles and liquid that might be present. The gas then flows through a back pressure regulator (if specified) which is set at least 0.5 bar (7 psi) above atmospheric pressure. Next comes an orifice to provide flow regulation followed by a flow indicator to measure flow. The pressure indicator is used to ensure the pressure is not above the seal chamber pressure. The last elements on the panel are a check valve and block valve. Buffer gas is then routed to the seal using tubing. A containment seal vent (CSV) and drain (CSD) are also located on the gland.

The inner mechanical seal is flushed by an API Plan 13.

Actions before first start up:

The pump will be delivered with correct vertical adjustment of the rotor.



Try to turn the rotor by hand. If the rotor cannot be turned readjust it following procedure in section 5.3.1 *Adjusting of the rotor*. The mechanical seal requires no adjustment anymore. Check if the mounting plates are already swung out.

Actions after start up:

Check all connections to the seal gland and the mechanical seal itself against leakage. It is usual that at the seal faces a small leakage occurs after start

up, which decreases with the time of operation and should stop after the seal is run in. Check the temperature of the seal gland. A slight increase of temperature may be observed during the run in period. The mechanical seal is flushed by an API Plan 13 and the temperature at the seal gland should be max. 10 °C (18 °F) above the pumped liquid temperature, unless otherwise specified by mechanical seal supplier.

API Plan 13 provides self venting although a blinded venting connection is foreseen. This connection shall be used by pumping flushing hydrocarbons at ambiente temperatures and above. The seal chamber is subjected to discharge pressure.

Plan 76 is suitable only for fluids, where no condensation of the inner seal leakage or from the collection system will occur.

Leakage from the inner mechanical seal is restricted from escape by the containment seal and goes out the containment seal vent. An orifice in the outlet line of the collector restricts flow such that high leakage of the inner seal will cause a pressure increase and trigger the PSH set at a gauge pressure of 0.7 bar (10 psi). The block valve in the outlet serves to isolate the system for maintenance. It may also be used to test the inner seal by closing while the pump is in operation and noting the time/pressure buildup relationship in the collector. If specified, drain connection on the piping harness may be used to inject nitrogen or other gas for the purpose of testing the containment seal as well as for checking for any liquid buildup.



Disassembly of the seal cartridge is only allowed by authorized personal. Contact Flowserve for any service of the mechanical seal. We recommend to have a spare cartridge seal on stock for easy replacement.

7.1.3 Dual Mechanical Seal pressurized with API-Plan 53a

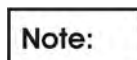

Refer to mechanical seal drawing and auxiliary piping drawing. The pump is equipped with a dual mechanical seal in face to back configuration, back to back configuration or face to face configuration.

Actions before first start up:

The pump will be delivered with correct vertical adjustment of the rotor.



Try to turn the rotor by hand. If the rotor cannot be turned readjust it following procedure in section 5.3.1 *Adjusting of the rotor*.

The mechanical seal requires no adjustment anymore. Check if the mounting plates are already swung out.

Actions after start up:

Check all connections to the seal gland and the mechanical seal itself against leakage. Check the temperature of the seal gland. A slight increase of temperature may be observed during the run in period.

Plan 53 pressurized dual seal systems are used in services where no leakage to atmosphere can be tolerated. A Plan 53a system consists of dual mechanical seals with a liquid barrier fluid between them. The barrier fluid is contained in a seal pot which is pressurized to a pressure of approximately 1.5 bar (23 psi) greater than the pump seal chamber. Inner seal leakage will be barrier fluid leakage into the product. There will always be some leakage (max.5 ml/hour).

The leakage rate is monitored by monitoring the seal pot level. The product must be able to accommodate a small amount of contamination from the barrier fluid. The seal pot pressure must be maintained at the proper level. If the seal pot pressure drops, the system will begin to operate like a Plan 52, or unpressurized dual seal, which does not offer the same level of sealing integrity. Specifically, the inner seal leakage direction will be reversed and the barrier fluid will, over time, become contaminated with the process fluid with the problems that result, including possible seal failure.

CAUTION Fill the seal system with a suitable barrier buffer fluid (refer to lubrication table).

CAUTION Open all necessary valves in the cooling and auxiliary piping and check the flow.

CAUTION Disassembly of the seal cartridge is only allowed by authorized personal. Contact Flowserve for any service of the mechanical seal. We recommend to have a spare cartridge seal on stock for easy replacement.

7.2 Changing of mechanical seal

7.2.1 Changing of mechanical seal with rigid spacer type coupling

- 1) If the pump is mounted on a tank, ensure that explosive or toxic gases are drained completely. By pumping explosive or toxic media, flush the tank with Nitrogen.
- 2) Secure the mechanical seal by putting the mounting plates into the groove of the shaft sleeve. Loose the shrunk ring, and disconnect the seal piping.

CAUTION Drain the seal system, if applicable.

- 3) Loose the socket head cap screw [6579.1] and slip down the rotor by turning the shaft nut [2910].

Note: If applicable pull off the fan [8161] after loosening the grub screw [6814.3]. Use an anaerobic adhesive for securing the socket set screw for reassembly.

- 4) Open the socket head cap screws [6579.3] move the coupling half [7200] and remove the intermediate coupling [7021].
- 5) Now remove the coupling ring split [7415], the coupling half [7200] and the key [6700.8].
- 6) Loose the studs [6572.2] and pull off the mechanical seal cartridge.
- 7) For assembly follow the reverse procedure.

7.2.2 Changing of mechanical seal without rigid spacer type coupling

- 1) If the pump is mounted on a tank, ensure that explosive or toxic gases are drained completely. By pumping explosive or toxic media, flush the tank with Nitrogen.
- 2) Pull off the coupling hub from the pump shaft [2110] and take out the key [6700.1].
- 3) Secure the mechanical seal by putting the mounting plates into the groove of the shaft sleeve. Loose the shrunk ring, and disconnect the seal piping.

CAUTION Drain the seal system, if applicable.

- 4) Drain the oil from the bearing housing using the plug [6569.1].
- 5) Loose the socket head cap screw [6579.1] and slip down the rotor by turning the shaft nut [2910] and remove it. Take off the labyrinth ring [4330.1].

Note: If applicable pull off the fan [8161] after loosening the grub screw [6814.3].

- 6) Loose the studs [6572.1] take off the bearing cover [3260.1] and remove the key [6700.2].

Note: Take care of the springs [4260]. Pull off the bearing housing [3200]. Loose the studs [6572.2] and pull off the mechanical seal cartridge.

- 7) For assembly follow reverse procedure.

Note: Adjust the rotor axially according to section 5.3 *Impeller clearance*.

8.0 FAULTS; CAUSES AND REMEDIES

FAULT SYMPTOM

Pump overheats and seizes												
↓	Bearings have short life											
	↓	Pump vibrates or is noisy										
		↓	Mechanical seal has short life									
			↓	Mechanical seal leaks excessively								
				↓	Pump requires excessive power							
					↓	Pump loses prime after starting						
						↓	Insufficient pressure developed					
							↓	Insufficient capacity delivered				
								↓	Pump does not deliver liquid			
									↓	PROBABLE CAUSES		POSSIBLE REMEDIES
										A. SYSTEM TROUBLES		
●										●	Pump not primed.	Check complete filling
	●			●	●					●	Pump or suction pipe not completely filled with liquid.	Check and complete filling
●	●			●	●					●	Suction lift too high or level too low.	Check NPSHa>NPSHr, proper submergence, losses at strainers / fittings
				●	●	●					Excessive amount of air or gas in liquid.	Check and purge from pipes
				●	●	●					Air or vapour pocket in suction line.	Check suction line design for pockets
				●	●						Air leaks into suction line.	Check airtight pipe then joints and gaskets
				●	●						Air leaks into pump through mechanical seal, sleeve joints, casing joint or pipe lugs.	Check airtight assembly then joints and gaskets
	●				●						Foot valve too small.	Investigate replacing the foot valve
	●				●						Foot valve partially clogged.	Clean foot valve
	●			●	●	●					Inlet of suction pipe insufficiently submerged.	Check cut out system design
					●	●	●				Total head of system higher than differential head of pump.	Check discharge head and head losses in discharge pipe at the valve settings. Check back pressure is not too high
				●							Total head of system lower than pump design head.	Throttle at discharge valve or ask Flowserve if the impeller can be trimmed
				●							Specific gravity of liquid different from design.	Consult Flowserve
				●	●	●					Viscosity of liquid differs from that for which designed.	Consult Flowserve
●	●										Operation at very low capacity.	Measure value and check minimum permitted
	●	●		●							Operation at high capacity.	Measure value and check maximum permitted
											B. MECHANICAL TROUBLES	
●	●	●	●	●	●						Misalignment due to pipe strain.	Check the flange connections and eliminate strains using elastic couplings or a method permitted
		●									Improperly designed foundation.	Check setting of baseplate: tighten, adjust, grout base as required
	●	●	●	●	●						Shaft bent.	Check shaft runouts within acceptable values
●	●	●		●							Rotating part rubbing on stationary part internally.	Check for signs of this and consult Flowserve if necessary
●	●	●	●	●							Bearings worn	Replace bearings
				●	●	●					Wearing ring surfaces worn.	Replace worn wear ring/ surfaces
		●				●	●				Impeller damaged or eroded.	Replace impeller and check reason
				●							Leakage under sleeve due to joint failure.	Replace joint and check for damage
		●	●	●							Mechanical seal improperly installed.	Check alignment of faces or damaged parts and assembly method used

FAULT SYMPTOM

Pump overheats and seizes													
↓												↓ Bearings have short life	
	↓											Pump vibrates or is noisy	
		↓										Mechanical seal has short life	
			↓									Mechanical seal leaks excessively	
				↓								Pump requires excessive power	
					↓							Pump loses prime after starting	
						↓						Insufficient pressure developed	
							↓					Insufficient capacity delivered	
								↓				Pump does not deliver liquid	
									↓			PROBABLE CAUSES	POSSIBLE REMEDIES
				●	●	●						Incorrect type of mechanical seal for operating conditions.	Consult Flowserve
●	●	●	●	●								Shaft running off centre because of worn bearings or misalignment.	Check misalignment and correct if necessary. If alignment satisfactory check bearings for excessive wear
●	●	●	●	●								Impeller out of balance resulting in vibration.	Check and consult Flowserve
			●	●	●							Abrasive solids in liquid pumped.	Check and consult Flowserve
			●	●								Mechanical seal was run dry.	Check mechanical seal condition and source of dry running and repair
			●	●								Internal misalignment due to improper repairs causing impeller to rub.	Check method of assembly, possible damage or state of cleanliness during assembly
●	●	●										Excessive thrust caused by a mechanical failure inside the pump.	Check wear condition of Impeller, its clearances and liquid passages
	●	●										Excessive grease in ball bearings.	Check method of regreasing
	●	●										Lack of lubrication for bearings.	Check hours run since last change of lubricant, the schedule and its basis
	●	●										Improper installation of bearings	Check method of assembly, possible damage or state of cleanliness during assembly and type of bearing used
	●	●										Damaged bearings due to contamination.	Check contamination source and replace damaged bearings
												C. ELECTRICAL TROUBLES	
		●		●	●	●						Wrong direction of rotation.	Reverse 2 phases on motor terminal box
	●	●								●		Motor running too slow,	Check motor terminal box connections

9.0 CERTIFICATION

Certificates determined from the contract requirements are provided with these instructions where applicable. Examples are certificates for CE marking, ATEX marking etc. If required, copies of other certificates sent separately to the Purchaser should be obtained from the Purchaser for retention with these User Instructions.

10.0 OTHER RELEVANT DOCUMENTATION AND MANUALS

10.1 Supplementary user instructions

Supplementary instructions determined from the contract requirements for inclusion into user Instructions such as for a driver, instrumentation, controller, sub-driver, seals, sealant system, mounting component etc are included in the Data Book. If further copies of these are required they should be obtained from the supplier for retention with these user instructions.

Where any pre-printed set of user instructions are used, and satisfactory quality can be maintained only by avoiding copying these, they are included at the end of these user instructions such as within a standard clear polymer software protection envelope.

10.2 Change notes

If any changes, agreed with Flowserve, are made to the product after its supply, a record of the details should be maintained with these User Instructions.

10.3 Additional sources of information

Reference 1:

NPSH for Rotordynamic Pumps: a reference guide, Europump Guide No. 1, Europump & World Pumps, Elsevier Science, United Kingdom, 1999.

Reference 2:

Pump Handbook, 2nd edition, Igor J. Karassik et al, McGraw-Hill Inc., New York, 1993.

Reference 3:

ANSI/HI 1.1-1.5
Centrifugal Pumps - Nomenclature, Definitions, Application and Operation.

Reference 4:

ANSI B31.3 - Process Piping.

10.4 Abbreviations

Quantity	ISO unit	ISO unit abbreviation	Multiplication Factor ¹	US unit	US unit Abbreviation
Area	square metre	m ²	10.764	square feet	ft ²
	square centimetre	cm ²	0.155	square inch	in. ²
Capacity or Flow rate	Cubic metre/hour	m ³ /h	4.4033	US Gallons/minute	US gpm
Force	Newton	N	0.2248	pound.force	lbf
Head	metre	m	3.28084	feet	ft
Heat Energy	kilojoule	kJ	0.9478	British thermal unit	Btu
Length	metre	m	3.28084	feet	ft
	millimetre	mm	0.03937	inch	in.
	micrometre	µm	0.00003937	inch	in.
Mass	kilogram	kg	2.20462	pounds	lb.
	gram	g	0.035274	ounces	oz.
Moment of Inertia	kilogram square metre	kg.m ²	23.73	pounds square feet	lb.ft ²
Noise ⁴	decibel	dBA			
Power	kilowatt	kW	1.34102	horsepower	hp
Pressure ²	bar	bar	14.5	pounds/in. ²	psi
Rotational Speed	revs per minute	r/min			
Stress	Newton/square millimetre	N/mm ²	145.0	pounds/in. ²	psi
Temperature	degrees Celsius	°C	(1.8 x °C) + 32	degrees Fahrenheit	°F
Torque	Newton.metre	Nm	0.7376	pound.feet	lbf.ft
Unbalance	gram millimetre	g.mm	0.001389	ounce-inch	oz-in.
Velocity	metre/second	m/s	3.28084	feet/second	ft/sec
	millimetre/second	mm/s	0.03937	inches/second	in./sec
Vibration ³	millimetre/second	mm/s	0.03937	inches/second	in./sec
Viscosity	square millimetre/second or centiStoke	cSt			
Volume	cubic metre	m ³	264.2	US Gallons	US gal.
	litre	l	33.81	fluid ounce	Fl.oz.

¹ multiply the ISO unit by the multiplication factor to obtain US units

² where pressure is not stated to be absolute it is gauge

³ where not stated to be peak it is r.m.s.

⁴ sound pressure level LpA, re 1m - 20microPa, or sound power level LwA re 1 pW when sound power is applicable



AFTERMARKET DIRECTORY

OUR ADDRESS

Flowserve (Austria) GmbH
Industriestraße B/6
A-2345 Brunn/Geb., AUSTRIA

Tel: +43 / 2236 / 31530
Fax: +43 / 2236 / 33430
Mail: flowserve-brunn@flowserve.com

MESSAGES CAN BE LEFT ALSO ON OUR ANSWERING MACHINE

IMPORTANT NOTES:

PLEASE NOTE, THAT WARRANTY EXPIRES:

- USE OF NON GENUINE FLOWSERVE AUSTRIA PARTS FOR MAINTENANCE AND REPAIRS
- NO USE OF OUR SERVICE PERSONAL IN CASE OF REPAIRS DURING WARRANTY PERIOD

RECOMMENDATION:

- PLEASE ASK FOR OUR SPECIAL RATES
- PLEASE ALSO ASK OUR SERVICE PERSONAL ABOUT REPAIRING AND SERVICING YOUR PUMPS AFTER THE WARRANTY PERIOD

Please quote your service:

Name of Company:

Contact person:.....

Telephone:

Fax:

e-mail:

Country:

Pumpdata:

Type:

Serialno.:

Your Flowserve factory contacts:

Flowserve (Austria) GmbH
Industriestraße B6
2345 Brunn am Gebirge
Austria

Telefon: +43 2236 31530
Fax: +43 2236 33430
E.mail: flowserve-brunn@flowserve.com

**FLOWSERVE REGIONAL
SALES OFFICES:****USA and Canada**

Flowserve Corporation
5215 North O'Connor Blvd.
Suite 2300
Irving, Texas 75039-5421, USA
Telephone: +1 937 890 5839

Europe, Middle East, Africa

Flowserve Corporation
Parallelweg 13
4878 AH Etten-Leur
The Netherlands
Telephone: +31 76 502 8100

Latin America

Flowserve Corporation
Martín Rodríguez 4460
B1644CGN-Victoria-San
Fernando
Buenos Aires, Argentina
Telephone: +54 11 4006 8700
Telefax: +54 11 4714 1610

Asia Pacific

Flowserve Pte. Ltd.
10 Tuas Loop
Singapore 637345
Telephone: +65 6771 0600
Telefax: +65 6862 2329