



USER INSTRUCTIONS

Durco® Mark 3™ ISO close coupled

Close coupled, single stage, end suction, centrifugal,
chemical process pumps

PCN= 26999985 02-14 (E). Original instructions.

***Installation
Operation
Maintenance***

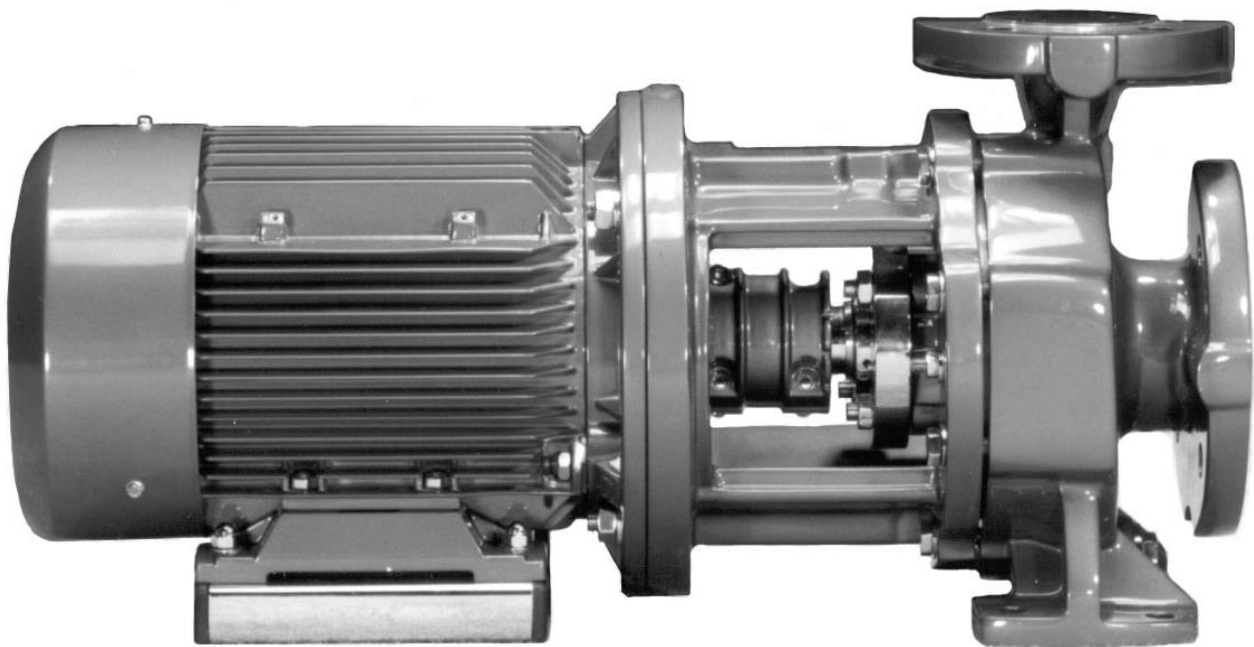

***These instructions must be read prior to installing,
operating, using and maintaining this equipment.***

Experience In Motion

CONTENTS

	Page		Page
1 INTRODUCTION AND SAFETY.....	4	6 MAINTENANCE	18
1.1 General	4	6.1 General	18
1.2 CE marking and approvals.....	4	6.2 Maintenance schedule.....	19
1.3 Disclaimer	4	6.3 Spare parts.....	19
1.4 Copyright.....	4	6.4 Recommended spares.....	20
1.5 Duty conditions.....	4	6.5 Tools required	20
1.6 Safety	5	6.6 Fastener torques.....	20
1.7 Nameplate and safety labels.....	8	6.7 Setting impeller clearance	20
1.8 Specific machine performance.....	8	6.8 Disassembly	20
1.9 Noise level.....	8	6.9 Examination of parts	21
2 TRANSPORT AND STORAGE.....	9	6.10 Assembly	21
2.1 Consignment receipt and unpacking.....	9	6.11 Seal arrangements.....	23
2.2 Handling	9	7 FAULTS; CAUSES AND REMEDIES.....	25
2.3 Lifting.....	9	8 PARTS LISTS AND DRAWINGS	27
2.4 Storage.....	9	8.1 Mark 3 ISO close coupled	27
2.5 Recycling and end of product life.....	10	8.2 Mark 3 ISO close coupled recessed impeller.....	28
3 DESCRIPTION	10	8.3 General arrangement drawing.....	29
3.1 Configurations	10	9 CERTIFICATION	29
3.2 Name nomenclature.....	10	10 OTHER RELEVANT DOCUMENTATION	
3.3 Design of major parts	10	AND MANUALS.....	29
3.4 Performance and operating limits	11	10.1 Supplementary User Instruction manuals... ..	29
4 INSTALLATION.....	11	10.2 Change notes	29
4.1 Location.....	11	10.3 Additional sources of information.....	29
4.2 Part assemblies.....	12		
4.3 Foundation	12		
4.4 Grouting	12		
4.5 Piping	13		
4.6 Electrical connections	14		
4.7 Protection systems.....	15		
5 COMMISSIONING, START-UP, OPERATION			
AND SHUTDOWN	15		
5.1 Pre-commissioning procedure	15		
5.2 Setting impeller clearance.....	15		
5.3 Direction of rotation	17		
5.4 Guarding	17		
5.5 Priming and auxiliary supplies	17		
5.6 Starting the pump	17		
5.7 Running the pump.....	17		
5.8 Stopping and shutdown.....	17		
5.9 Hydraulic, mechanical and electrical duty.....	18		

INDEX

Page	Page		
Additional sources (10.3).....	29	Receipt and unpacking (2.1).....	9
Assembly (6.10).....	21	Recommended spares (6.4).....	20
ATEX marking (1.6.4.2).....	7	Recycling (2.5).....	10
CE marking and approvals (1.2).....	4	Replacement parts (6.3 and 6.4).....	19/20
Certification (9).....	29	Running the pump (5.7).....	17
Change notes (10.2).....	29	Safety action (1.6.3).....	5
Clearances, impeller (6.7).....	20	Safety markings (1.6.1).....	5
Commissioning and operation (5).....	15	Safety, protection systems (1.6 and 4.7)	
Compliance, ATEX (1.6.4.1).....	6	Sealing arrangements (6.11).....	23
Configurations (3.1).....	10	Sectional drawings (8).....	27
Copyright (1.4).....	4	Setting impeller clearance (6.7).....	20
Design of major parts (3.3).....	10	Sound pressure level (1.9, Noise level).....	8
Direction of rotation (5.3).....	17	Sources, additional information (10.3).....	29
Disassembly (6.8).....	20	Spare parts (6.3).....	19
Disclaimer (1.3).....	4	Specific machine performance (1.8).....	8
Dismantling (6.8, Disassembly).....	20	Starting the pump (5.6).....	17
Drawings (8).....	27	Stop/start frequency (5.7.3).....	17
Duty conditions (1.5).....	4	Stopping and shutdown (5.8).....	17
Electrical connections (4.6).....	14	Storage, pump (2.4).....	9
End of product life (2.5).....	10	Storage, spare parts (6.3.2).....	19
Examination of parts (6.9).....	21	Supplementary manuals or information sources.....	29
Fastener torques (6.6).....	20	Supplementary User Instructions (10.1).....	29
Faults; causes and remedies (7).....	25	Tools required (6.5).....	18
Foundation (4.3).....	12	Torques for fasteners (6.6).....	20
General arrangement drawing (8.3).....	29	Trouble-shooting (see 7).....	25
General assembly drawings (8).....	27	Vibration (5.7.2).....	17
Grouting (4.4).....	12	Warning labels (1.7.2).....	8
Guarding (5.4).....	17		
Handling (2.2).....	9		
Hydraulic, mechanical and electrical duty (5.9).....	18		
Impeller clearance (5.2).....	15		
Inspection (6.2.1 and 6.2.2).....	19		
Installation (4).....	11		
Lifting (2.3).....	9		
Location (4.1).....	11		
Lubrication (5.1.1).....	15		
Maintenance (6).....	18		
Maintenance schedule (6.2).....	19		
Motor choices.....	11		
Name nomenclature (3.2).....	10		
Operating limits (3.4.1).....	11		
Ordering spare parts (6.3.1).....	19		
Part assemblies (4.2).....	12		
Parts lists (8).....	27		
Performance (3.4).....	11		
Piping (4.5).....	13		
Pre-commissioning (5.1).....	15		
Priming and auxiliary supplies (5.5).....	17		
Protection systems (4.7).....	15		
Re-assembly (6.10, Assembly).....	21		

1 INTRODUCTION AND SAFETY

1.1 General



These instructions must always be kept close to the product's operating location or directly with the product.

Flowserve products are designed, developed and manufactured with state-of-the-art technologies in modern facilities. The unit is produced with great care and commitment to continuous quality control, utilising sophisticated quality techniques and safety requirements.

Flowserve is committed to continuous quality improvement and being at service for any further information about the product in its installation and operation or about its support products, repair and diagnostic services.

These instructions are intended to facilitate familiarization with the product and its permitted use. Operating the product in compliance with these instructions is important to help ensure reliability in service and avoid risks. The instructions may not take into account local regulations; ensure such regulations are observed by all, including those installing the product. Always coordinate repair activity with operations personnel, and follow all plant safety requirements and applicable safety and health laws/regulations.



These instructions should be read prior to installing, operating, using and maintaining the equipment in any region worldwide. The equipment must not be put into service until all the conditions relating to safety noted in the instructions, have been met.

1.2 CE marking and approvals

It is a legal requirement that machinery and equipment put into service within certain regions of the world shall conform with the applicable CE Marking Directives covering Machinery and, where applicable, Low Voltage Equipment, Electromagnetic Compatibility (EMC), Pressure Equipment Directive (PED) and Equipment for Potentially Explosive Atmospheres (ATEX).

Where applicable, the Directives and any additional Approvals, cover important safety aspects relating to machinery and equipment and the satisfactory provision of technical documents and safety instructions. Where applicable this document incorporates information relevant to these Directives and Approvals.

To confirm the Approvals applying and if the product is CE marked, check the serial number plate markings and the Certification. (See section 9, *Certification*.)

1.3 Disclaimer

Information in these User Instructions is believed to be reliable. In spite of all the efforts of Flowserve Corporation to provide sound and all necessary information the content of this manual may appear insufficient and is not guaranteed by Flowserve as to its completeness or accuracy.

Flowserve manufactures products to exacting International Quality Management System Standards as certified and audited by external Quality Assurance organisations. Genuine parts and accessories have been designed, tested and incorporated into the products to help ensure their continued product quality and performance in use. As Flowserve cannot test parts and accessories sourced from other vendors the incorrect incorporation of such parts and accessories may adversely affect the performance and safety features of the products. The failure to properly select, install or use authorised Flowserve parts and accessories is considered to be misuse. Damage or failure caused by misuse is not covered by the Flowserve warranty. In addition, any modification of Flowserve products or removal of original components may impair the safety of these products in their use.

1.4 Copyright

All rights reserved. No part of these instructions may be reproduced, stored in a retrieval system or transmitted in any form or by any means without prior permission of Flowserve Pump Division.

1.5 Duty conditions

This product has been selected to meet the specifications of your purchaser order. The acknowledgement of these conditions has been sent separately to the Purchaser. A copy should be kept with these instructions.



The product must not be operated beyond the parameters specified for the application. If there is any doubt as to the suitability of the product for the application intended, contact Flowserve for advice, quoting the serial number.

If the conditions of service on your purchase order are going to be changed (for example liquid pumped, temperature or duty) it is requested that the user seeks the written agreement of Flowserve before start-up.

1.6 Safety

1.6.1 Summary of safety markings

These User Instructions contain specific safety markings where non-observance of an instruction would cause hazards. The specific safety markings are:

 **DANGER** This symbol indicates electrical safety instructions where non-compliance will involve a high risk to personal safety or the loss of life.

 This symbol indicates safety instructions where non-compliance would affect personal safety and could result in loss of life.

 This symbol indicates “hazardous and toxic fluid” safety instructions where non-compliance would affect personal safety and could result in loss of life.

 **CAUTION** This symbol indicates safety instructions where non-compliance will involve some risk to safe operation and personal safety and would damage the equipment or property.

 This symbol indicates explosive atmosphere zone marking according to ATEX. It is used in safety instructions where non-compliance in the hazardous area would cause the risk of an explosion.

 This symbol is used in safety instructions to remind not to rub non-metallic surfaces with a dry cloth; ensure the cloth is damp. It is used in safety instructions where non-compliance in the hazardous area would cause the risk of an explosion.

Note: This sign is not a safety symbol but indicates an important instruction in the assembly process.

1.6.2 Personnel qualification and training

All personnel involved in the operation, installation, inspection and maintenance of the unit must be qualified to carry out the work involved. If the personnel in question do not already possess the necessary knowledge and skill, appropriate training and instruction must be provided. If required the operator may commission the manufacturer/supplier to provide applicable training.

Always coordinate repair activity with operations and health and safety personnel, and follow all plant safety requirements and applicable safety and health laws and regulations.

1.6.3 Safety action

This is a summary of conditions and actions to help prevent injury to personnel and damage to the environment and to equipment. For products used in potentially explosive atmospheres section 1.6.4 also applies.

 **DANGER** NEVER DO MAINTENANCE WORK WHEN THE UNIT IS CONNECTED TO POWER

 **GUARDS MUST NOT BE REMOVED WHILE THE PUMP IS OPERATIONAL**

 **DRAIN THE PUMP AND ISOLATE PIPEWORK BEFORE DISMANTLING THE PUMP**
The appropriate safety precautions should be taken where the pumped liquids are hazardous.

 **FLUORO-ELASTOMERS (When fitted.)**
When a pump has experienced temperatures over 250 °C (482 °F), partial decomposition of fluoro-elastomers (example: Viton) will occur. In this condition these are extremely dangerous and skin contact must be avoided.

 **HANDLING COMPONENTS**
Many precision parts have sharp corners and the wearing of appropriate safety gloves and equipment is required when handling these components. To lift heavy pieces above 25 kg (55 lb) use a crane appropriate for the mass and in accordance with current local regulations.

 **DO NOT ATTEMPT TO REMOVE THE IMPELLER FROM THE STUB SHAFT; THEY ARE AN INTEGRAL ITEM ON THIS PUMP.**

 **HOT (and cold) PARTS**
If hot or freezing components or auxiliary heating supplies can present a danger to operators and persons entering the immediate area action must be taken to avoid accidental contact. If complete protection is not possible, the machine access must be limited to maintenance staff only, with clear visual warnings and indicators to those entering the immediate area. Note: bearing housings must not be insulated and drive motors and bearings may be hot.

If the temperature is greater than 80 °C (175 °F) or below -5 °C (20 °F) in a restricted zone, or exceeds local regulations, action as above shall be taken.



THERMAL SHOCK

Rapid changes in the temperature of the liquid within the pump can cause thermal shock, which can result in damage or breakage of components and should be avoided.



HAZARDOUS LIQUIDS

When the pump is handling hazardous liquids care must be taken to avoid exposure to the liquid by appropriate siting of the pump, limiting personnel access and by operator training. If the liquid is flammable and or explosive, strict safety procedures must be applied.



CAUTION PREVENT EXCESSIVE EXTERNAL PIPE LOAD

Do not use pump as a support for piping. Do not mount expansion joints, unless allowed by Flowserve in writing, so that their force, due to internal pressure, acts on the pump flange.



CAUTION ENSURE CORRECT LUBRICATION
(See section 5, *Commissioning, startup, operation and shutdown.*)



CAUTION START THE PUMP WITH OUTLET VALVE PART OPENED
(Unless otherwise instructed at a specific point in the User Instructions.)

This is recommended to minimize the risk of overloading and damaging the pump or motor at full or zero flow. Pumps may be started with the valve further open only on installations where this situation cannot occur. The pump outlet control valve may need to be adjusted to comply with the duty following the run-up process. (See section 5, *Commissioning start-up, operation and shutdown.*)



CAUTION NEVER RUN THE PUMP DRY



CAUTION INLET VALVES TO BE FULLY OPEN WHEN PUMP IS RUNNING

Running the pump at zero flow or below the recommended minimum flow continuously will cause damage to the pump and mechanical seal.



CAUTION DO NOT RUN THE PUMP AT ABNORMALLY HIGH OR LOW FLOW RATES

Operating at a flow rate higher than normal or at a flow rate with no back pressure on the pump may overload the motor and cause cavitation. Low flow rates may cause a reduction in pump/bearing life, overheating of the pump, instability and cavitation/vibration.

1.6.4 Products used in potentially explosive atmospheres



Measures are required to:

- Avoid excess temperature
- Prevent build up of explosive mixtures
- Prevent the generation of sparks
- Prevent leakages
- Maintain the pump to avoid hazard

The following instructions for pumps and pump units when installed in potentially explosive atmospheres must be followed to help ensure explosion protection. Both electrical and non-electrical equipment must meet the requirements of European Directive 94/9/EC.

1.6.4.1 Scope of compliance



Use equipment only in the zone for which it is appropriate. Always check that the driver, drive coupling assembly, seal and pump equipment are suitably rated and/or certified for the classification of the specific atmosphere in which they are to be installed.

Where Flowserve has supplied only the bare shaft pump, the Ex rating applies only to the pump. The party responsible for assembling the pump set shall select the driver and any additional equipment, with the necessary CE Certificate/ Declaration of Conformity establishing it is suitable for the area in which it is to be installed.

The output from a variable frequency drive (VFD) can cause additional heating effects in the motor and so, for pumps sets with a VFD, the ATEX Certification for the motor must state that it covers the situation where electrical supply is from the VFD. This particular requirement still applies even if the VFD is in a safe area.

1.6.4.2 Marking

An example of ATEX equipment marking is shown below. The actual classification of the pump will be engraved on the nameplate.

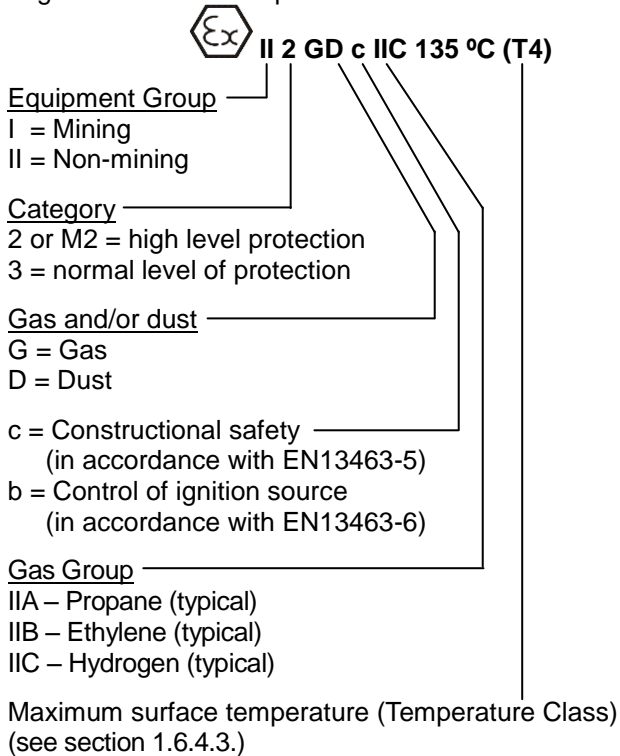

1.6.4.3 Avoiding excessive surface temperatures

ENSURE THE EQUIPMENT TEMPERATURE CLASS IS SUITABLE FOR THE HAZARD ZONE

Pumps have a temperature class as stated in the ATEX Ex rating on the nameplate. These are based on a maximum ambient of 40 °C (104 °F); refer to Flowserve for higher ambient temperatures.

The surface temperature on the pump is influenced by the temperature of the liquid handled. The maximum permissible liquid temperature depends on the temperature class and must not exceed the values in the table that follows.

The temperature rise at the seals and bearings and due to the minimum permitted flow rate is taken into account in the temperatures stated.

Temperature class to EN13463-1	Maximum surface temperature permitted	Temperature limit of liquid handled (* depending on material and construction variant - check which is lower)
T6	85 °C (185 °F)	Consult Flowserve
T5	100 °C (212 °F)	Consult Flowserve
T4	135 °C (275 °F)	115 °C (239 °F) *
T3	200 °C (392 °F)	180 °C (356 °F) *
T2	300 °C (572 °F)	275 °C (527 °F) *
T1	450 °C (842 °F)	400 °C (752 °F) *

The responsibility for compliance with the specified maximum liquid temperature is with the plant operator.

Temperature classification “Tx” is used when the liquid temperature varies and when the pump is required to be used in differently classified potentially explosive atmospheres. In this case the user is responsible for ensuring that the pump surface temperature does not exceed that permitted in its actual installed location.

Where there is any risk of the pump being run against a closed valve generating high liquid and casing external surface temperatures it is recommended that users fit an external surface temperature protection device.

Avoid mechanical, hydraulic or electrical overload by using motor overload trips, temperature monitor or a power monitor and make routine vibration monitoring checks.

In dirty or dusty environments, regular checks must be made and dirt removed from areas around close clearances, bearing housings and motors.

1.6.4.4 Preventing the build up of explosive mixtures

ENSURE THE PUMP IS PROPERLY FILLED AND VENTED AND DOES NOT RUN DRY

Ensure the pump and relevant suction and discharge pipeline system is totally filled with liquid at all times during the pump operation, so that an explosive atmosphere is prevented. In addition it is essential to make sure that seal chambers, auxiliary shaft seal systems and any heating and cooling systems are properly filled.

If the operation of the system cannot avoid this condition the fitting of an appropriate dry run protection device is recommended (for example liquid detection or a power monitor).

To avoid potential hazards from fugitive emissions of vapour or gas to atmosphere the surrounding area must be well ventilated.

1.6.4.5 Preventing sparks

To avoid the potential hazard from random induced current generating a spark, the earth contact on the baseplate must be used.

Avoid electrostatic charge: do not rub non-metallic surfaces with a dry cloth; ensure cloth is damp.

Additional requirement for metallic pumps on non-metallic baseplates

When metallic components are fitted on a non-metallic baseplate they must be individually earthed.

1.6.4.6 Preventing leakage

The pump must only be used to handle liquids for which it has been approved to have the correct corrosion resistance.

Avoid entrapment of liquid in the pump and associated piping due to closing of suction and discharge valves, which could cause dangerous excessive pressures to occur if there is heat input to the liquid. This can occur if the pump is stationary or running.

Bursting of liquid containing parts due to freezing must be avoided by draining or protecting the pump and ancillary systems.

Where there is the potential hazard of a loss of a seal barrier fluid or external flush, the fluid must be monitored.

If leakage of liquid to atmosphere can result in a hazard, the installation of a liquid detection device is recommended.

1.6.4.7 Maintenance to avoid the hazard

CORRECT MAINTENANCE IS REQUIRED TO AVOID POTENTIAL HAZARDS WHICH GIVE A RISK OF EXPLOSION

The responsibility for compliance with maintenance instructions is with the plant operator.

To avoid potential explosion hazards during maintenance, the tools, cleaning and painting materials used must not give rise to sparking or adversely affect the ambient conditions. Where there is a risk from such tools or materials, maintenance must be conducted in a safe area.

It is recommended that a maintenance plan and schedule is adopted. (See section 6, *Maintenance*.)

1.7 Nameplate and safety labels

1.7.1 Nameplate

For details of nameplate, see the *Declaration of Conformity*, or separate documentation included with these User Instructions.

1.7.2 Safety labels

		WARNING	J218JZ250
ESSENTIAL PROCEDURES BEFORE STARTING:			
INSTALL AND OPERATE EQUIPMENT IN ACCORDANCE WITH THE INSTRUCTION MANUAL SUPPLIED SEPARATELY. ENSURE GUARDS ARE SECURELY IN PLACE. ENSURE CORRECT DIRECTION OF ROTATION.	ENSURE ALL EXTERNAL CONNECTIONS TO THE PUMP / SHAFT SEALING AND DRIVER ARE CONNECTED AND OPERATIONAL. FULLY PRIME UNIT AND SYSTEM. DO NOT RUN UNIT DRY.	FAILURE TO FOLLOW THESE PROCEDURES MAY RESULT IN PERSONAL INJURY AND / OR EQUIPMENT DAMAGE	

1.8 Specific machine performance

For performance parameters see section 1.5, *Duty conditions*. Where performance data has been supplied separately to the purchaser these should be obtained and retained with these User Instructions if required.

1.9 Noise level

Attention must be given to the exposure of personnel to the noise, and local legislation will define when guidance to personnel on noise limitation is required, and when noise exposure reduction is mandatory. This is typically 80 to 85 dBA.

The usual approach is to control the exposure time to the noise or to enclose the machine to reduce emitted sound. You may have already specified a limiting noise level when the equipment was ordered, however if no noise requirements were defined, then attention is drawn to the following table to give an indication of equipment noise level so that you can take the appropriate action in your plant.

Pump noise level is dependent on a number of operational factors, flow rate, pipework design and acoustic characteristics of the building, and so the values given are subject to a 3 dBA tolerance and cannot be guaranteed.

Similarly the motor noise assumed in the “pump and motor” noise is that typically expected from standard and high efficiency motors when on load directly driving the pump. Note that a motor driven by an inverter may show an increased noise at some speeds.

Motor size and speed kW (hp)	Typical sound pressure level L_{pA} at 1 m reference 20 μ Pa, dBA							
	3 550 r/min		2 900 r/min		1 750 r/min		1 450 r/min	
	Pump only	Pump and motor	Pump only	Pump and motor	Pump only	Pump and motor	Pump only	Pump and motor
<0.55(<0.75)	72	72	64	65	62	64	62	64
0.75 (1)	72	72	64	66	62	64	62	64
1.1 (1.5)	74	74	66	67	64	64	62	63
1.5 (2)	74	74	66	71	64	64	62	63
2.2 (3)	75	76	68	72	65	66	63	64
3 (4)	75	76	70	73	65	66	63	64
4 (5)	75	76	71	73	65	66	63	64
5.5 (7.5)	76	77	72	75	66	67	64	65
7.5 (10)	76	77	72	75	66	67	64	65
11(15)	80	81	76	78	70	71	68	69
15 (20)	80	81	76	78	70	71	68	69
18.5 (25)	81	81	77	78	71	71	69	71
22 (30)	81	81	77	79	71	71	69	71
30 (40)	83	83	79	81	73	73	71	73
37 (50)	83	83	79	81	73	73	71	73

Note: for 1 180 and 960 r/min reduce 1 450 r/min values by 2 dBA. For 880 and 720 r/min reduce 1 450 r/min values by 3 dBA.

If a pump unit only has been purchased for fitting with your own driver then the “pump only” noise levels in the table should be combined with the level for the driver obtained from the supplier. Consult Flowserve or a noise specialist if assistance is required in combining the values.

It is recommended that where exposure approaches the prescribed limit, then site noise measurements should be made.

The values are in sound pressure level L_{pA} at 1 m (3.3 ft) from the machine, for “free field conditions over a reflecting plane”.

For estimating sound power level L_{WA} (re 1 pW) then add 14 dBA to the sound pressure value.

2 TRANSPORT AND STORAGE

2.1 Consignment receipt and unpacking

Immediately after receipt of the equipment it must be checked against the delivery/shipping documents for its completeness and that there has been no damage in transportation. Any shortage and/or damage must be reported immediately to Flowserve Pump Division and must be received in writing within one month of receipt of the equipment. Later claims cannot be accepted.

Check any crate, boxes or wrappings for any accessories or spare parts that may be packed separately with the equipment or attached to side walls of the box or equipment.

Each product has a unique serial number. Check that this number corresponds with that advised and always quote this number in correspondence as well as when ordering spare parts or further accessories.

2.2 Handling

Boxes, crates, pallets or cartons may be unloaded using fork lift vehicles or slings dependent on their size and construction.

2.3 Lifting

A crane must be used for all pump sets in excess of 25 kg (55 lb). Fully trained personnel must carry out lifting, in accordance with local regulations.

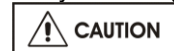

No specific lifting points are provided for this complete machine (unless so specified). Any lifting points that can be seen are provided only for dismantling parts for servicing. Slings, ropes and other lifting gear should be positioned where they cannot slip and where a balanced lift is obtained.

Before lifting the driver alone, refer to the manufacturer’s instructions.

2.4 Storage



Store the pump in a clean, dry location away from vibration. Leave piping connection covers in place to keep dirt and other foreign material out of pump casing. Turn pump at intervals to prevent brinelling of the bearings and the seal faces, if fitted, from sticking.

The pump may be stored as above for up to 6 months. Consult Flowserve for preservative actions when a longer storage period is needed.

2.5 Recycling and end of product life

At the end of the service life of the product or its parts, the relevant materials and parts should be recycled or disposed of using an environmentally acceptable method and local requirements. If the product contains substances that are harmful to the environment, these should be removed and disposed of in accordance with current regulations. This also includes the liquids and/or gases that may be used in the "seal system" or other utilities.



Make sure that hazardous substances are disposed of safely and that the correct personal protective equipment is used. The safety specifications must be in accordance with the current regulations at all times.

3 DESCRIPTION

3.1 Configurations

The pump is a modular designed centrifugal pump that can be built to achieve almost all chemical liquid pumping requirements. (See 3.2 and 3.3 below.)

3.2 Name nomenclature

The pump size will be engraved on the nameplate typically as below:

CK80-50-200A-OP

- C = Close Coupled Identification Letter
- K = Durco Mark 3 family
- 80 = Nominal suction size in mm
- 50 = Nominal discharge size in mm
- Configuration modifier:
Blank or no letter = standard frame mounted
P = Self priming casing
R = Recessed impeller, low shear design
- 200 = Nominal impeller diameter
- A = Extended flow hydraulic (B = standard hydraulic)
- RV = Impeller design (RV = Reverse vane, OP = Open)

The typical nomenclature above is the general guide to the Mark 3 ISO Close Coupled configuration description. Identify the actual pump size and serial number from the pump nameplate. Check that this agrees with the applicable certification provided.

3.3 Design of major parts

3.3.1 Pump casing

The pump casing is designed with a horizontal centerline end inlet and a vertical centerline top outlet which makes it self venting.

For ease of maintenance, the pump is constructed so that pipe connectors do not have to be disturbed when internal maintenance is required.

3.3.2 Adjustment stud

The adjustment stud is screwed into the end of the motor shaft. Adjustment of impeller front clearance is achieved by rotating the stub shaft on this stud.

3.3.3 Muff coupling

The muff coupling is investment cast in two halves (WCB steel). Notches at 30 degree increments around the circumference of the coupling assist in setting the impeller face clearance.

3.3.4 Pump bearings and lubrication

The pump uses the motor bearings to support and position the pump shaft. See motor instruction book for lubrication details.

3.3.5 Seal housing

The seal housing has spigots between the motor pedestal and bearing housing for optimum concentricity.

A fully confined gasket forms the seal between the pump casing and the seal housing.

The seal housings designs provide improved performance of mechanical seals.

The design enables one of a number of sealing options to be fitted.

3.3.6 Shaft seal

The mechanical seal(s) attached to the stub shaft seals the pumped liquid from the environment.

3.3.7 Driver

The driver is a close-coupled electric motor featuring bearing location. This provides positive rotor assembly location to limit axial movement and allow accurate impeller setting.

Motor choices:

Motor manufacturer and type		Motor frame size						
		Flange mounted		Foot/flange mounted				
		80	90	100/112	132	160	180	200
TECO standard 'AEBB'	Standard motor acceptable?	Yes	No	No	Yes	Yes	Yes	Yes
	With alternative 2A grease?	N/A	Yes (1)	Yes (1)	N/A	N/A	N/A	N/A
TECO aluminium range	Standard motor acceptable?	No	No	No	No	No	-	-
	With drive end bearing location?	Yes	Yes	Yes	Yes	Yes	-	-
ABB standard 'M2AA'	Standard motor acceptable?	Yes	Yes	Yes	Yes	Yes	Yes	Yes
LEROY SOMER standard 'LSB 5'	Standard motor acceptable?	Yes	Yes	Yes	Yes	Yes	Yes	Yes
ELECTRODRIVES standard 'ALPAK'	Standard motor acceptable?	No	No	No	No	Yes	Yes	Yes
	With drive end bearing location?	Yes (2)	Yes (2)	Yes (2)	Yes (2)	N/A	N/A	N/A
BROOK HANSEN standard 'ARGUS'	Standard motor acceptable?	No	No	No	No	No	No	No
	With drive end bearing location?	Yes	Yes	Yes	Yes	Yes	Yes	Yes
SIEMENS standard 'LA'	Standard motor acceptable?	No	No	No	No	Yes	Yes	Yes
	With drive end bearing location?	Yes	Yes	Yes	Yes	N/A	N/A	N/A
VEM Standard 'K21R'	Standard motor acceptable?	No	No	No	No	No	No	No
	With drive end bearing location?	Yes	Yes	Yes	Yes	Yes	Yes	Yes
GAMAK Standard 'AGM/AG'	Standard motor acceptable?	No	No	No	No	No	No	No
	With drive end bearing location?	Yes	Yes	Yes	Yes	Yes	Yes	Yes
WEG 'W21' cast iron	Standard motor acceptable?	Yes	Yes	Yes	Yes	Yes	Yes	Yes

Notes: N/A = Not applicable.

- 1) The standard grease used on TECO motor frames 90, 100 and 112 is unsuitable as it does not generate sufficient lubricating film thickness with the relatively low viscosity 5K grease. The alternative grease 2A is acceptable **and must be specified**.
- 2) Standard ALPAK motor frames 80 to 132 inclusive have bearings at the non-drive end with a special retention device. This device is not acceptable for use with the Mark 3 ISO Close Coupled unit. The ALPAK machine with bearing cap locating the drive end bearing is acceptable.

A wide range of electric motors have been tested and approved for use with Mark 3 ISO Close Coupled units. The table lists acceptable motors and indicates whether the standard motors are approved or if a modification is required.

The position of the terminal box can be changed by rotating the complete motor. To do this on motor frames 80 and 90, remove the fasteners from the motor flange, rotate the motor and re-fit the fasteners. For motor frames 100 and above, with multi-positioned feet, also unbolt the feet and refit in the appropriate position.

3.3.9 Accessories

Accessories may be fitted when specified by the customer.

3.4 Performance and operating limits

This product has been selected to meet the specifications of the purchase order. See section 1.5.

The following data is included as additional information to help with your installation. It is typical, and factors such as temperature, materials, and seal type may influence this data. If required, a definitive statement for your particular application can be obtained from Flowserve.

3.4.1 Operating limits

3.4.1.1 Temperature limits of working fluids

Horizontal units: -20 °C (-4 °F) to +160 °C (320 °F).
Vertical units: -20 °C (-4 °F) to +120 °C (248 °F).
(These limits subject to approved mechanical seal area design.)

3.4.1.2 Ambient temperature

These units are normally fitted with TEFC motors suitable for an ambient temperature up to 40 °C (104 °F). Specific pumps may be fitted with motors to suit client's requirements with other ambient temperature limits - see motor nameplate for details.

4 INSTALLATION



Equipment operated in hazardous locations must comply with the relevant explosion protection regulations. See section 1.6.4, *Products used in potentially explosive atmospheres*.

4.1 Location

The pump should be located to allow room for access, ventilation, maintenance and inspection with ample headroom for lifting and should be as close as practicable to the supply of liquid to be pumped. Refer to the general arrangement drawing for the pump set.

Various pump positions are possible. (See diagram.)

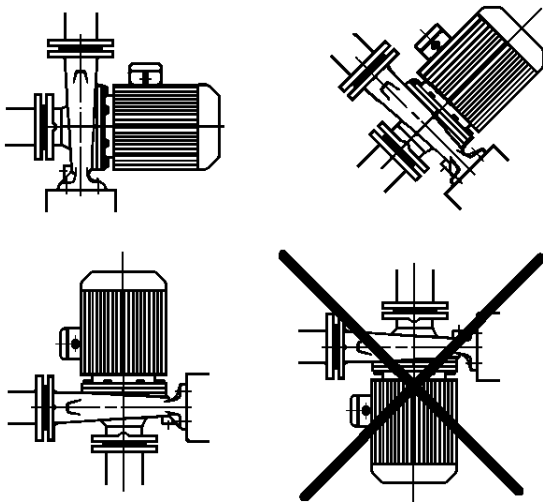

It is possible for the pump/motor assembly to be supported by the connecting pipework if it is suitably stable and rigid. For hot, damp environments, the preferred orientation is horizontal.

4.2 Part assemblies

These pumps are not normally supplied in part assemblies but special accessories such as loose orifice plates are supplied loose. Ensure these are incorporated in the final installation.

4.3 Foundation

CAUTION There are many methods of installing pump units to their foundations. The correct method depends on the size of the pump unit, its location and noise and vibration limitations. Non-compliance with the provision of correct foundation and installation may lead to failure of the pump and, as such, would be outside the terms of the warranty.

Where a baseplate is used, it should be mounted onto a firm foundation, either an appropriate thickness of quality concrete or sturdy steel framework. It should be packed or shimmed underneath to avoid distortion when pulled down onto the surface of the foundation.

Where supplied, install the baseplate onto packing pieces evenly spaced and adjacent to foundation bolts.

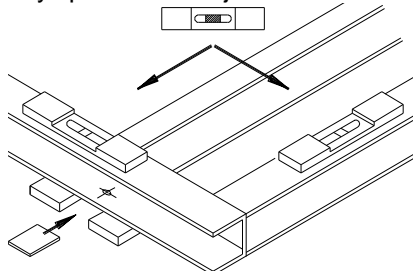

Level with shims between baseplate and packing pieces.

If the pump is being directly mounted onto a plinth, it is only necessary to bolt down the pump foot.

Units fitted with 80 or 90 frame size motors require bolting down at the pump end only. It is recommended that bolts (not studs) are used to hold down the pump feet to permit easy removal from the pipework.

Do not distort the pump when tightening the holding down bolts. Use shims under the motor feet as necessary.

All units should be securely bolted down at the pump casing. In addition, the motor (frames 100 and above) should be supported under its feet with metal packing strips.

It is not necessary to bolt the motor to the foundation. However, to simplify maintenance, it is important that any packing strips are bolted to the motor feet. This is so that the motor, complete with packing strips, can be slipped back along its foundation to gain access to the rotating element. It is important to bolt down the pump casing first. The motor should then be packed or shimmed to support its weight, but it should not put any undue strain onto the pump casing. (It is not necessary to support frame 80 and 90 motors.)

CAUTION These close coupled pumps feature a back pull-out design. This means that when correctly installed, the rotating element can be withdrawn from the casing without disturbing the system pipework. The use of grouted-in studs to secure the motor feet prevents back pull-out and will make maintenance more difficult and time consuming. The procedures in the above paragraphs should be followed in order to obtain the maximum benefit from the pump design.

4.4 Grouting

Where applicable, grout in the foundation bolts.

After adding pipework connections the baseplate, if used, should be grouted in accordance with good engineering practice. Folded steel baseplates should be grouted to locate their packing pieces. If in any doubt please contact your nearest Flowserve service center for advice.

Grouting provides solid contact between the pump unit and foundation, prevents lateral movement of vibrating equipment and dampens resonant vibrations.

4.5 Piping



Protective covers are fitted to the pipe connections to prevent foreign bodies entering during transportation and installation. Ensure that these covers are removed from the pump before connecting any pipes.

4.5.1 Suction and discharge pipework



Never use pump as a support for piping.

Take into account the available NPSH which must be higher than the required NPSH of the pump.

In order to minimize friction losses and hydraulic noise in the pipework it is good practice to choose pipework that is one or two sizes larger than the pump suction and discharge. Typically main pipework velocities should not exceed 2 m/s (6 ft/sec) suction and 3 m/s (9 ft/sec) on the discharge.

Maximum forces and moments allowed on the pump flanges vary with the pump size and type. To minimize these forces and moments that may, if excessive, cause misalignment, hot bearings, worn couplings, vibration and the possible failure of the pump casing, the following points should be strictly followed:

- Prevent excessive external pipe load
- Never draw piping into place by applying force to pump flange connections
- Do not mount expansion joints so that their force, due to internal pressure, acts on the pump flange



Ensure piping and fittings are flushed before use.



Ensure piping for hazardous liquids is arranged to allow pump flushing before removal of the pump.

4.5.2 Suction piping

- a) The inlet pipe should be one or two sizes larger than the pump inlet bore and pipe bends should be as large a radius as possible.
- b) On suction lift the piping should be inclined up towards the pump inlet with eccentric reducers incorporated to prevent air locks.
- c) On positive suction, the inlet piping must have a constant fall towards the pump.
- d) The pipe next to the pump should be the same diameter as the pump suction and have a minimum of two pipe diameters of straight section between the elbow and the pump inlet flange. Where the NPSH margin is not large, it is

recommended that the pipe straight is 5 to 10 pipe diameter. (See section 10.3, Reference 1.) Inlet strainers, when used, should have a net 'free area' of at least three times the inlet pipe area.

- e) Fitting isolation and non-return valves will allow easier maintenance.
- f) Never throttle pump on suction side and never place a valve directly on the pump inlet nozzle.

4.5.3 Discharge piping

- a) A non-return valve should be located in the discharge pipework to protect the pump from excessive back pressure and hence reverse rotation when the unit is stopped.
- b) Fitting an isolation valve will allow easier maintenance.

4.5.4 Flange loads

The permissible flange loading is dependent on a number of factors such as dimensions, flange rating, pressure, temperature, material, pump configuration, etc. The recommendations contained in the section on pipework connections should be followed to eliminate these loads.

When requested the permissible flange loading will have been supplied separately to the purchaser and should be obtained and retained with this manual. If in doubt contact Flowserve for information.

4.5.5 Auxiliary piping



The connections that are to be piped up will have been fitted with protective metal or plastic plugs which will need to be removed.

4.5.5.1 Pumps fitted with mechanical seals

The conical design of the single internal seal housing provides excellent liquid circulation around the seal and will not normally require a separate flush.

Single seals requiring re-circulation will normally be provided with the auxiliary piping from pump casing already fitted.

Flowserve seal connections are designated as follows:

- Q - quench
- F - flush
- D - drain outlet
- BI - barrier fluid in (double seals)
- BO - barrier fluid out (double seals)
- H - heating jacket

Seal housings/covers having an auxiliary quench connection, require connection to a suitable source of liquid flow, low pressure steam or static pressure from a header tank. Recommended pressure is 0.35 bar (5 psi) or less. Check *General arrangement drawing*.

Double seals require a barrier liquid between the seals, compatible with the pumped liquid.

With back-to-back double seals, the barrier liquid should be at a minimum pressure of 1 bar (14.5 psi) above the maximum pressure on the pump side of the inner seal. (See chart.) The barrier liquid pressure must not exceed limitations of the seal on the atmospheric side. For toxic service the barrier liquid supply and discharge must be in a safe area.

Special seals may require modification to auxiliary piping described above. Consult Flowserve if unsure of correct method or arrangement.

For pumping hot liquids, to avoid seal damage, it is recommended that any external flush/cooling supply be continued after stopping the pump.

Seal chamber pressure v generated head:

Mechanical seal	Use seal manufacturer's limits or ask seal manufacturer to verify seal pressure
-----------------	---

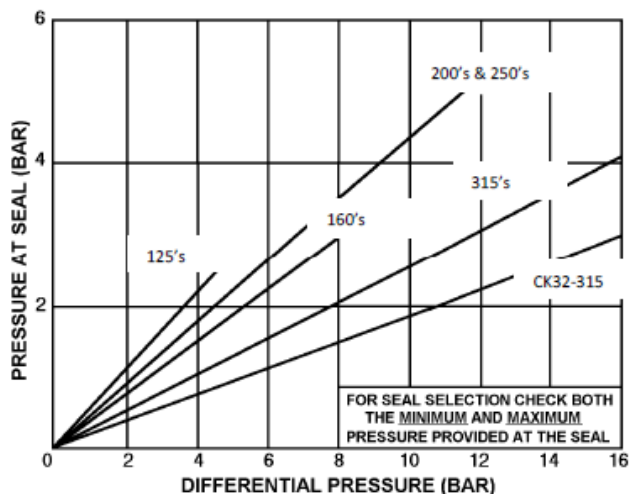

Notes:

- Total seal pressure is equal to pressure at seal plus suction pressure.
- For pumped liquid viscosities greater than 440 Centistokes multiply the generated pressure by 1.25 for 125, 160 and 200 size pumps and by 2.0 for larger sizes.
- Differential pressure in bar equals head in metres multiplied by specific gravity all divided by 10.19.
- Ensure to check the seal minimum and maximum seal pressure limits are not exceeded and the pressure is agreed with Flowserve.

4.5.5.2 Pumps fitted with heating jackets

Connect the heating pipes from the site supply. The top connection should be used as the outlet to ensure complete filling/venting of the annulus with heating liquids. Steam is usually in at the top, out at the bottom.

4.5.5 Final checks

After connecting piping to the pump, rotate the shaft several times by applying gentle pressure on the motor fan to ensure there is no binding and all parts are free.

Check the tightness of all bolts in the suction and discharge pipework. Check also the tightness of all foundation bolts.

4.6 Electrical connections

DANGER Electrical connections must be made by a qualified Electrician in accordance with relevant local national and international regulations.

It is important to be aware of the EUROPEAN DIRECTIVE on potentially explosive areas where compliance with IEC60079-14 is an additional requirement for making electrical connections.

It is important to be aware of the EUROPEAN DIRECTIVE on electromagnetic compatibility when wiring up and installing equipment on site. Attention must be paid to ensure that the techniques used during wiring/installation do not increase electromagnetic emissions or decrease the electromagnetic immunity of the equipment, wiring or any connected devices. If in any doubt contact Flowserve for advice.

DANGER The motor must be wired up in accordance with the motor manufacturer's instructions (normally supplied within the terminal box) including any temperature, earth leakage, current and other protective devices as appropriate. The identification nameplate should be checked to ensure the power supply is appropriate.

A device to provide emergency stopping must be fitted.

If not supplied pre-wired to the pump unit, the controller/starter electrical details will also be supplied within the controller/starter.

For electrical details on pump sets with controllers see the separate wiring diagram.

CAUTION See section 5.4, *Direction of rotation* before connecting the motor to the electrical supply.

4.7 Protection systems



The following protection systems are recommended particularly if the pump is installed in a potentially explosive area or is handling a hazardous liquid. If in any doubt consult Flowserve.

If there is any possibility of the system allowing the pump to run against a closed valve or below minimum continuous safe flow a protection device should be installed to ensure the temperature of the liquid does not rise to an unsafe level.

If there are any circumstances in which the system can allow the pump to run dry, or start-up empty, a power monitor should be fitted to stop the pump or prevent it from being started. This is particularly relevant if the pump is handling a flammable liquid.

If leakage of product from the pump or its associated sealing system can cause a hazard it is recommended that an appropriate leakage detection system is installed.

To prevent excessive surface temperatures at bearings it is recommended that temperature or vibration monitoring are carried out.

5 COMMISSIONING, START-UP, OPERATION AND SHUTDOWN



These operations must be carried out by fully qualified personnel.

5.1 Pre-commissioning procedure

5.1.1 Lubrication

Electric motors are supplied pre-greased and are normally sealed for life. If in doubt, refer to motor instruction manual.

5.2 Setting impeller clearance

This procedure may be required after the pump has been dismantled or a different clearance is required.

Before carrying out this procedure ensure that the mechanical seal(s) [4200] fitted can tolerate a change in their axial setting, otherwise it will be necessary to dismantle the unit and reset the seal axial position after adjusting the impeller clearance.

If a cartridge seal is fitted loosen it from the shaft.

5.2.1 Setting front clearance on ISO-M open impeller (OP)

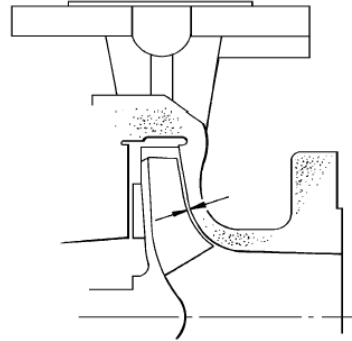

Clearance settings:

Impeller diameter		Motor frame size							
		80	90	100	112	132	160	180	200
Up to 210 mm	Clearance (mm)	0.3	0.3	0.3	0.3	0.3	0.3	0.3	0.3
	Notches	7	7	7	7	7	8	8	8
211 to 315 mm	Clearance (mm)	0.4	0.4	0.4	0.4	0.4	0.4	0.4	0.4
	Notches	8	8	8	8	8	9	9	9

- Disconnect the muff coupling [7120] and clean up the bores.
- Clean motor shaft and stub shaft and deburr where necessary.
- Replace muff coupling [7120], ensuring that the grub screw locates in the stub shaft.
- The motor end coupling bolts [6570.2] should be slacker than the pump end coupling bolts [6570.4] so that the coupling and stub shaft can be rotated relative to the motor shaft.
- The motor shaft should be prevented from rotating by using a C-spanner located in the keyway (where possible) or by locking the fan end of the motor [8100].
- Rotate the coupling [7120] until the impeller [2200] contacts the pump casing [1100]. This is the zero clearance position or datum for setting the front clearance.
- Mark the bracket with a pen and, whilst preventing the motor shaft rotating, turn the coupling [7120] in the opposite direction by the recommended number of notches as indicated in the table. For the remaining steps, take care not to rotate the pump shaft relative to the motor shaft.
- Carefully loosen and back off the grub screw and tighten the coupling bolts [6570.4], ensuring that the gap is equal between the coupling halves [7120].
- Torque the screws to the specified values:
M8 – 30 Nm (22 lbf•ft)
M10 – 58 Nm (43 lbf•ft)
- Check that the shaft can turn freely without binding.
- If a cartridge seal is fitted it should be reset at this point.

5.2.2 Setting rear clearance on ISO-M reverse vane impeller (RV)

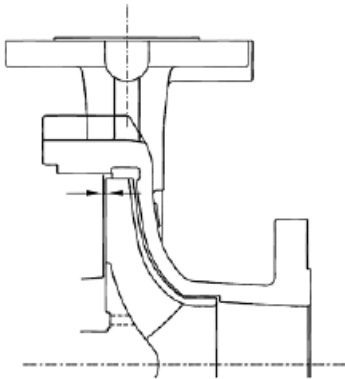

Clearance settings:

Impeller diameter		Motor frame size							
		80	90	100	112	132	160	180	200
Up to 210 mm	Clearance (mm)	0.3	0.3	0.3	0.3	0.3	0.3	0.3	0.3
	Notches	7	7	7	7	7	8	8	8
211 to 315 mm	Clearance (mm)	0.4	0.4	0.4	0.4	0.4	0.4	0.4	0.4
	Notches	8	8	8	8	8	9	9	9

Reverse vane impellers are set off the cover [1220]. This allows the impeller [2200] to be set without the casing [1100].

- Disconnect the muff coupling [7120] and clean up the bores.
- Clean motor shaft and stub shaft and deburr where necessary.
- Replace muff coupling [7120], ensuring that the grub screw locates in the stub shaft.
- The motor end coupling bolts [6570.2] should be slacker than the pump end coupling bolts [6570.4] so that the coupling and stub shaft can be rotated relative to the motor shaft.
- The motor shaft should be prevented from rotating by using a C-spanner located in the keyway (where possible) or by locking the fan end of the motor [8100].
- With the casing [1100] removed, rotate the coupling [7120] until the impeller contacts the cover [1220]. This is the zero clearance position or datum for setting the rear clearance.
- Mark the bracket with a pen and, whilst preventing the motor shaft rotating, turn the coupling [7120] in the opposite direction by the recommended number of notches as indicated in the table. For the remaining steps, take care not to rotate the pump shaft relative to the motor shaft.
- Carefully loosen and back off the grub screw and tighten the coupling bolts [6570.4], ensuring that the gap is equal between the coupling halves [7120].
- Torque the screws to the specified values:
M8 – 30 Nm (22 lbf•ft)
M10 – 58 Nm (43 lbf•ft)

- Push the impeller [2200] axially towards the cover [1220] to close the motor bearing axial play.
- Ensure the impeller rear clearance is as indicated in the table using a feeler gauge.
- Check that the shaft can turn freely without binding.
- If a cartridge seal is fitted it should be reset at this point.

5.2.3 Setting rear clearance on ISO-RM recessed impeller

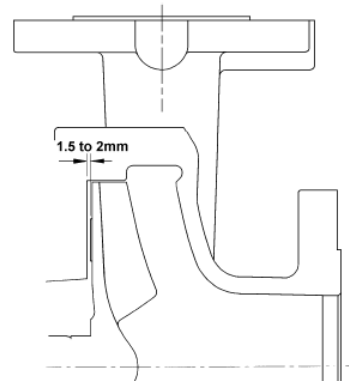

Recessed open impellers are set off the cover [1220]. This allows the impeller [2200] to be set without the casing [1100].

- Disconnect the muff coupling [7120] and clean up the bores. Ensure the casing [1100] is not fitted.
- Clean motor shaft and stub shaft and deburr where necessary.
- Replace muff coupling [7120], ensuring that the grub screw locates in the stub shaft.
- The motor end coupling bolts [6570.2] should be slacker than the pump end coupling bolts [6570.4] so that the coupling and stub shaft can be rotated relative to the motor shaft.
- The motor shaft should be prevented from rotating by using a C-spanner located in the keyway (where possible) or by locking the fan end of the motor [8100].
- With the casing [1100] removed, rotate the coupling [7120] until the rear clearance is 1.5 to 2 mm (0.06 to 0.08 in) as illustrated. This is the setting position. For the remaining steps, take care not to rotate the pump shaft relative to the motor shaft.
- Carefully loosen and back off the grub screw and tighten the coupling bolts [6570.4], ensuring that the gap is equal between the coupling halves [7120].
- Torque the screws to the specified values:
M8 – 30 Nm (22 lbf•ft)
M10 – 58 Nm (43 lbf•ft)
- Check that the shaft can turn freely without binding.
- If a cartridge seal is fitted it should be reset at this point.

5.3 Direction of rotation

Briefly run or jog the motor and observe the direction of rotation of the coupling or motor fan. Ensure the pump is given the same direction of rotation as the pump direction arrow on the bracket.

If maintenance work has been carried out to the site's electricity supply, the direction of rotation should be re-checked as above in case the supply phasing has been altered.

5.4 Guarding

Guarding is supplied fitted to the pump set. If this has been removed or disturbed ensure that all the protective guards are securely refitted.

5.5 Priming and auxiliary supplies

5.5.1 Filling and priming

Ensure inlet pipe and pump casing is completely full of liquid before starting continuous duty operation.

Priming may be carried out with an ejector, vacuum pump interceptor or other equipment, or by flooding from the inlet source.

When in service, pumps using inlet pipes with foot valves may be primed by passing liquid back from the outlet pipe through the pump.

5.5.2 Auxiliary supplies

Ensure all electrical, hydraulic, pneumatic, sealant and lubrication systems (as applicable) are connected and operational.

5.6 Starting the pump

- Ensure flushing and or heating liquid supplies are turned ON, before starting pump.
- CLOSE the outlet valve.
- OPEN all inlet valves.
- Prime the pump.
- Start motor and check the outlet pressure.
- If the pressure is satisfactory, slowly OPEN the outlet valve.
- Do not run the pump with the outlet valve closed for a period longer than 30 seconds.
- If NO pressure, or LOW pressure, STOP the pump. Refer to section 7, *Faults; causes and remedies* for fault diagnosis.

5.7 Running the pump

5.7.1 Pumps fitted with mechanical seal

Mechanical seals require no adjustment. Any slight initial leakage will stop when the seal is run in.

Before pumping dirty liquids it is advisable, if possible, to run the pump in using clean liquid to safeguard the seal face.

External flush or quench should be started before the pump is run and allowed to flow for a period after the pump has stopped.

Never run a mechanical seal dry, even for a short time.

5.7.2 Normal vibration levels, alarm and trip

For guidance, pumps generally fall under a classification for rigid support machines within the International rotating machinery standards and the recommended maximum levels below are based on those standards.

Alarm and trip values for installed pumps should be based on the actual measurements (N) taken on the pump in the fully commissioned as new condition. Measuring vibration at regular intervals will then show any deterioration in pump or system operating conditions.

Vibration velocity – unfiltered	Horizontal pumps ≤ 15 kW mm/sec (in./sec) r.m.s.	> 15 kW mm/sec (in./sec) r.m.s.
Normal N	≤ 3.0 (0.12)	≤ 4.5 (0.18)
Alarm N x 1.25	≤ 3.8 (0.15)	≤ 5.6 (0.22)
Shutdown trip N x 2.0	≤ 6.0 (0.24)	≤ 9.0 (0.35)

5.7.3 Stop/start frequency

Pump sets are normally suitable for the number of equally spaced stop/starts per hour shown in the table below. Check capability of the driver and control/starting system before commissioning.

Motor rating kW (hp)	Maximum stop/starts per hour
Up to 15 (20)	15
Between 15 (20) and 90 (120)	10
Above 90 (120)	6

Where duty and standby pumps are installed it is recommended that they are run alternately every week.

5.8 Stopping and shutdown

- Close the outlet valve, but ensure that the pump runs in this condition for no more than a few seconds.
- Stop the pump.

- c) Switch off flushing and or heating liquid supplies at a time appropriate to the process.
- d)  For prolonged shut-downs and especially when ambient temperatures are likely to drop below freezing point, the pump and any cooling and flushing arrangements must be drained or otherwise protected.

5.9 Hydraulic, mechanical and electrical duty

This product has been supplied to meet the performance specifications of your purchase order, however it is understood that during the life of the product these may change. The following notes may help the user decide how to evaluate the implications of any change. If in doubt contact your nearest Flowserve office.

5.9.1 Specific gravity (SG)

Pump capacity and total head in metres (feet) do not change with SG, however pressure displayed on a pressure gauge is directly proportional to SG. Power absorbed is also directly proportional to SG. It is therefore important to check that any change in SG will not overload the pump driver or over-pressurize the pump.

5.9.2 Viscosity

For a given flow rate the total head reduces with increased viscosity and increases with reduced viscosity. Also for a given flow rate the power absorbed increases with increased viscosity, and reduces with reduced viscosity. It is important that checks are made with your nearest Flowserve office if changes in viscosity are planned.

5.9.3 Pump speed

Changing pump speed effects flow, total head, power absorbed, $NPSH_R$, noise and vibration. Flow varies in direct proportion to pump speed, head varies as speed ratio squared and power varies as speed ratio cubed. The new duty, however, will also be dependent on the system curve. If increasing the speed, it is important therefore to ensure the maximum pump working pressure is not exceeded, the driver is not overloaded, $NPSH_A > NPSH_R$, and that noise and vibration are within local requirements and regulations.

5.9.4 Net positive suction head ($NPSH_A$)

$NPSH$ available ($NPSH_A$) is a measure of the head available in the pumped liquid, above its vapour pressure, at the pump suction branch.

$NPSH$ required ($NPSH_R$) is a measure of the head required in the pumped liquid, above its vapour pressure, to prevent the pump from cavitating. It is

important that $NPSH_A > NPSH_R$. The margin between $NPSH_A > NPSH_R$ should be as large as possible.

If any change in $NPSH_A$ is proposed, ensure these margins are not significantly eroded. Refer to the pump performance curve to determine exact requirements particularly if flow has changed.

If in doubt please consult your nearest Flowserve office for advice and details of the minimum allowable margin for your application.

5.9.5 Pumped flow

Flow must not fall outside the minimum and maximum continuous safe flow shown on the pump performance curve and or data sheet.

6 MAINTENANCE

6.1 General

 It is the plant operator's responsibility to ensure that all maintenance, inspection and assembly work is carried out by authorized and qualified personnel who have adequately familiarized themselves with the subject matter by studying this manual in detail. (See also section 1.6.2.)

Any work on the machine must be performed when it is at a standstill. It is imperative that the procedure for shutting down the machine is followed, as described in section 5.8.

On completion of work all guards and safety devices must be re-installed and made operative again.

Before restarting the machine, the relevant instructions listed in section 5, *Commissioning, start-up, operation and shut down* must be observed.

Oil and grease leaks may make the ground slippery. Machine maintenance must always begin and finish by cleaning the ground and the exterior of the machine.

If platforms, stairs and guard rails are required for maintenance, they must be placed for easy access to areas where maintenance and inspection are to be carried out. The positioning of these accessories must not limit access or hinder the lifting of the part to be serviced.

When air or compressed inert gas is used in the maintenance process, the operator and anyone in the vicinity must be careful and have the appropriate protection.

Do not spray air or compressed inert gas on skin.

Do not direct an air or gas jet towards other people.

Never use air or compressed inert gas to clean clothes.

Before working on the pump, take measures to prevent an uncontrolled start. Put a warning board on the starting device with the words:

"Machine under repair: do not start".

With electric drive equipment, lock the main switch open and withdraw any fuses. Put a warning board on the fuse box or main switch with the words:

"Machine under repair: do not connect".

Never clean equipment with inflammable solvents or carbon tetrachloride. Protect yourself against toxic fumes when using cleaning agents.

6.2 Maintenance schedule



It is recommended that a maintenance plan and schedule is adopted, in line with these User Instructions, to include the following:

- a) Any auxiliary systems installed must be monitored, if necessary, to ensure they function correctly.
- b) Check for any leaks from gaskets and seals. The correct functioning of the shaft seal must be checked regularly.
- c) Check that the duty condition is in the safe operating range for the pump.
- d) Check vibration, noise level and surface temperature at the bearings to confirm satisfactory operation.
- e) Check dirt and dust is removed from areas around close clearances, bearing housings and motors.

Our specialist service personnel can help with preventative maintenance records and provide condition monitoring for temperature and vibration to identify the onset of potential problems.

If any problems are found the following sequence of actions should take place:

- a) Refer to section 7, *Faults; causes and remedies*, for fault diagnosis.
- b) Ensure equipment complies with the recommendations in this manual.
- c) Contact Flowserve if the problem persists.

6.2.1 Routine inspection (daily/weekly)



The following checks should be made and the appropriate action taken to remedy any deviations:

- a) Check operating behaviour. Ensure noise, vibration and bearing temperatures are normal.
- b) Check that there are no abnormal fluid or lubricant leaks (static and dynamic seals) and that any sealant systems (if fitted) are full and operating normally.
- c) Check that shaft seal leaks are within acceptable limits.
- d) Check any auxiliary supplies eg heating/cooling (if fitted) are functioning correctly.



Refer to the manuals of any associated equipment for routine checks needed.

6.2.2 Periodic inspection (six monthly)



Check foundation bolts for security of attachment and corrosion.



Refer to the manuals of any associated equipment for periodic checks needed.

6.2.3 Mechanical seals

When leakage becomes unacceptable the seal will need replacement.

6.3 Spare parts

6.3.1 Ordering of spares

Flowserve keeps records of all pumps that have been supplied. When ordering spares the following information should be quoted.

- 1) Pump serial number.
- 2) Pump size.
- 3) Part name – taken from section 8.
- 4) Part number – taken from section 8.
- 5) Number of parts required.

The pump size and serial number are shown on the pump nameplate.

To ensure continued satisfactory operation, replacement parts to the original design specification should be obtained from Flowserve. Any change to the original design specification (modification or use of a non-standard part) will invalidate the pump's safety certification.

6.3.2 Storage of spares

Spares should be stored in a clean dry area away from vibration. Inspection and re-treatment of metallic surfaces (if necessary) with preservative is recommended at 6 monthly intervals.

6.4 Recommended spares

Part no.	Designation	Number of pumps (including stand-by)						
		2	3	4	5	6/7	8/9	10 (+)
For start-up purposes								
4590	Pump casing gasket	4	6	8	9	12	150%	
2 to 4 years operation								
2200	Integral stub shaft and impeller	1	2	3	30%			
7120	Muff coupling (halves)	2	4	20%				
9906/04	Coupling grub screw	1	2	3	50%			
9951/02	Adjustment stud	1	2	3	50%			
4200	Mechanical seals	1	2	3	30%			
4300	Lip seal *	4	6	8	9	10	100%	
4590	Pump casing gasket	4	6	8	9	12	150%	
8100	Motor			-	1	2		
Optional for start-up purposes								
4200	Mechanical seals	1	2	3	30%			
9906/04	Coupling grub screw	1	2	3	50%			
9951/02	Adjustment stud	1	2	3	50%			
7120	Muff coupling (halves)	2	4	20%				

* Where fitted.

6.5 Tools required

A typical range of tools that will be required to maintain these pumps is listed below.

Readily available in standard tool kits, and dependent on pump size:

- Open ended spanners (wrenches) to suit up to M 20 screws/nuts
- Socket spanners (wrenches), up to M 20 screws
- Allen keys, up to 10 mm (A/F)
- Range of screwdrivers
- Soft mallet

More specialized equipment:

- Bearing pullers
- Bearing induction heater
- Dial test indicator
- C-spanner (wrench) - for removing shaft nut. (If difficulties in sourcing are encountered, consult Flowserve.)
- Tapered seal fitting tools for rubber bellows seals

6.6 Fastener torques

Screw position	Screw size	Torque Nm (lbf-ft)
Casing and seal cover	M8	16 (12)
	M10	25 (18)
	M12	35 (26)
	M16	80 (59)
	M20	130 (96)
Muff coupling	M8	30 (22)
	M10	58 (43)
Cartridge seal sleeve (where applicable)	M5	5.5 (7) *
	M8	16 (22) *

* Where a torque wrench is unavailable, slightly tighten the setscrews to centralize the cartridge seal, then tighten with a T-bar until a torsional twist between 60 and 90 degrees is achieved. The torque applied will be approximate to that recommended.



Non-metallic gaskets incur creep relaxation - before commissioning the pump check and retighten fasteners to tightening torques stated.

6.7 Setting impeller clearance

See section 5.2. This procedure may be required after the pump has been dismantled or a different clearance is required.

6.8 Disassembly



Refer to section 1.6, *Safety*, before dismantling the pump.

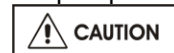

Before dismantling the pump for overhaul, ensure genuine Flowserve replacement parts are available.

Refer to sectional drawings for part numbers and identification. See section 8, *Parts lists and drawings*.

6.8.1 General

- Close suction and discharge valves and drain liquid from the pump.
- Remove screws from pump casing and pull motor complete with rotating assembly from back of pump casing, which will be left connected in position in the pipework.
- Unclip the coupling guards.
- Take out the muff coupling screws and remove coupling.

6.8.2 Pumps with single seals

- Prevent the motor shaft from rotating.
- Carefully rotate the impeller in an anti-clockwise rotation, whilst supporting the impeller, until it releases from the adjustment stud. Take care not to damage the seal.
- Withdraw the impeller/stub shaft assembly, complete with mechanical seal, from the seal housing.

- d) Release the tension in the mechanical seal. The seal manufacturer's instructions should be followed for dismantling and assembling the seal.
- e) Remove seal housing bolts and withdraw the seal housing from the bracket.

6.8.3 Pumps with double mechanical seals

- a) Remove the nuts retaining the seal housing to the bracket.
- b) Carefully rotate the impeller in an anti-clockwise direction whilst supporting the impeller and seal housing. The integral impeller and stub shaft combined with the seal housing will release from the unit as a sub-assembly. (Large pump sizes have a tapped hole for fitting a lifting eye to assist with this procedure.)
- c) Remove the nuts from the seal cover to gain access to the seals. Release the tension in the mechanical seals.
- d) The seal manufacturer's instructions should be followed for dismantling and assembling the seal.
- e) The mounting bracket can now be removed from the motor after first removing the fixing screws.
- f) The adjustment stud in the motor shaft can be removed using two M 8 nuts.

6.9 Examination of parts



Used parts must be inspected before assembly to ensure the pump will subsequently run properly. In particular, fault diagnosis is essential to enhance pump and plant reliability.

6.9.1 Casing, seal housing and integral impeller/stub shaft assembly

Inspect for excessive wear, pitting, corrosion, erosion or damage and any sealing surface irregularities. Replace as necessary.

6.9.2 Integral impeller/stub shaft

Replace if the shaft is grooved or pitted or if the impeller vanes are eroded or damaged.

6.9.3 Gaskets

After dismantling, discard and replace. (If the pump seal arrangement has a lip seal, it should be replaced at overhaul.)

6.9.4 Motor

Check the motor shaft for free rotation and absence of bearing noise or shaft 'float'. If necessary, have the motor serviced by a specialist or replace with a Flowserve approved type.

6.10 Assembly

To assemble the pump consult the sectional drawings. See section 8, *Parts lists and drawings*.

Ensure threads, gasket and O-ring mating faces are clean. Apply thread sealant to non-face sealing pipe thread fittings.

6.10.1 General

- a) The motor shaft keyway is not used but remove any burrs from the edge of the keyway, the motor and pump shafts and the coupling.
- b) Screw the adjustment stud into the motor shaft and tighten with the two M 8 nuts or a stud box.
- c) Locate the bracket on the motor spigot and tighten the screws (or studs and nuts).
- d) Whilst re-assembling, use new joints/gaskets and ensure they are in their correct positions.
- e) Small amounts of grease may be used to hold the joints in position during assembly.

6.10.2 Seal housing and seal assembly

- a) Extreme cleanliness is required.
- b) The sealing faces and shaft surface must be free from scratches or other damage.
- c) Refer to section 6.11, *Seal arrangements*, for seal diagrams.

6.10.3 Impeller assembly and setting - single seal

- a) Carefully press the stationary seat into the mechanical seal housing cover, ensuring the seating ring is not deformed.
- b) Where an anti-rotation pin is fitted, ensure that correct engagement with the slot is achieved.
- c) Refer to seal manufacturer's instructions to position the mechanical seal rotating elements. Tighten any drive screws in the seal drive collar.
- d) Fit the seal housing into the bracket and tighten all fasteners.
- e) Apply anti-seizing compound to the adjustment stud. Carefully, fit the stub shaft (with seal in position) through the center of the seal housing and locate on the adjustment stud.
- f) Rotate the impeller until the back clearance is approximately 1 mm (0.04 in.).
- g) Fit the casing gasket and pump casing and tighten all casing fasteners.
- h) Refer to section 5.2, *Setting impeller clearance*, for setting dimensions and coupling fitting instructions.
- i) Check that the shaft can turn freely without binding.

6.10.4 Impeller assembly and setting - double seal

For double seal arrangements, a sub assembly of the integral impeller/stub shaft, seal housing, seal cover and seals is required.

- a) Fit the impeller shaft through the seal housing.
- b) Refer to seal manufacturer's instructions to position the mechanical seal rotating elements. The short outboard seal is easier to assemble with a special tapered tool fitted to the end of the shaft.
- c) When the seals are in position, fit the seal cover and tighten all fasteners.
- d) Whilst supporting the seal housing, locate the stub shaft on the adjustment stud to ensure engagement. (Large pump sizes have a tapped hole for fitting a lifting eye to assist with this procedure.)
- e) Rotate the impeller until the back clearance is approximately 1 mm (0.04 in.).
- f) Long studs may be used initially to locate the seal housing and support the weight whilst the impeller is rotated.
- g) Ensure all flush connections are reconnected.
- h) Refer to section 5.2, *Setting impeller clearance*, for setting dimensions and coupling fitting instructions.
- i) Fit the casing gasket and pump casing and tighten all casing fasteners.
- j) Check that the shaft can turn freely without binding.

6.10.5 Impeller assembly and setting - cartridge seal

- a) Loosely fit the cartridge seal to the seal housing, then fit and tighten onto the bracket.
- b) Apply anti-seizing compound to the adjustment stud.
- c) Insert the impeller shaft and screw on until the gap between the impeller and seal housing is approximately 1 mm (0.04 in.).
- d) Fit the casing gasket and pump casing and tighten all casing fasteners.
- e) Refer to section 5.2, *Setting impeller clearance*, for setting dimensions and coupling fitting instructions.
- f) To set, or reset, a cartridge seal having a PTFE setting ring-throttle and no separate setting clips, finger tighten the seal cover studs nuts, then fully torque up the sleeve screws.
- g) Torque up the seal cover studs nuts.

6.11 Seal arrangements

The following section shows details of the seal arrangements. The dimensions provided are for non-step balanced mechanical seals conforming to EN 12757 L1K and L1N. Contact your nearest Flowserve sales office or service center if you require further information, such as a mechanical seal dimensional drawing, or are unsure of the specific arrangement supplied. Refer also to section 4.5.5, *Auxiliary piping*.

Pump size	Setting dimension (mm)			
	Stub shaft Ø 35		Stub shaft Ø 45	
	X	Y	X	Y
125	25.5	13	-	-
160	25.5	13	36	21
65-160	25.5	13	36	21
100-160	25.5	13	36	21
200	25.5	13	36	21
250	-	-	36	21
315	-	-	36	21

6.11.1 Single seal types

6.11.1a Single seal

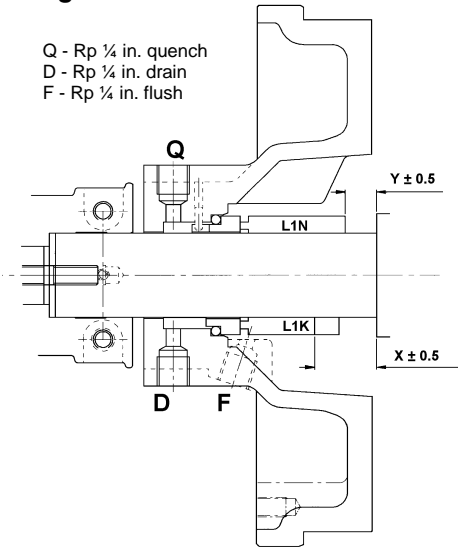

6.11.2 Single seal types with external lip seal

6.11.2a Single seal with external lip seal

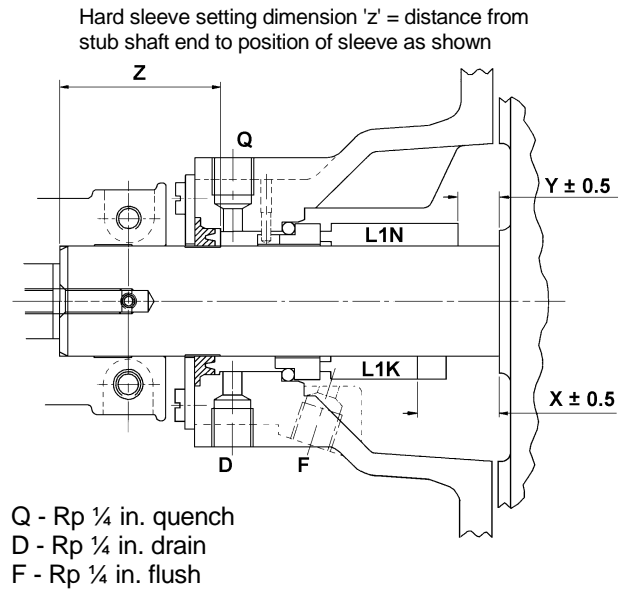

6.11.1b Single seal with external neck bush

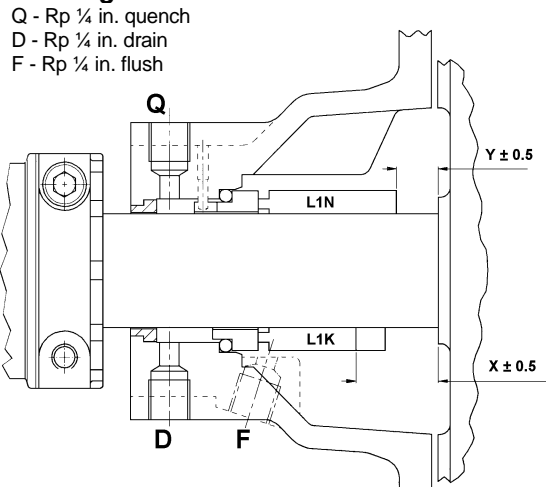

6.11.2b Single seal with external lip seal and quench pot

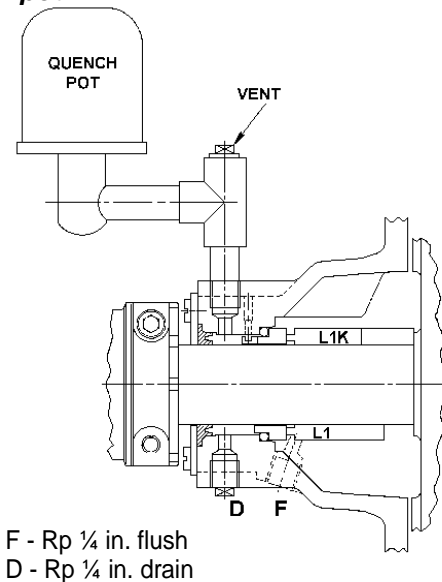

6.11.1c Single seal variants

- 1) Self setting collar.
- 2) Separate seal drive collar set to dimension 'X'.
- 3) Integral seal drive collar with screws set to dimension 'X'.

L1K and L1N are seal lengths defined within seal standard EN 12757.

6.11.2c Single seal with external lip seal variants

- 1) Self-setting collar.
- 2) Separate seal drive collar set to dimension 'X'.
- 3) Integral seal drive collar with screws set to dimension 'X'.

L1K and L1N are seal lengths defined within seal standard EN 12757.

Pump size	Setting dimension (mm)					
	Stub shaft Ø 35			Stub shaft Ø 45		
	X	Y	Z	X	Y	Z
125	25.5	13	50	-	-	-
160	25.5	13	50	36	21	68
65-160	25.5	13	50	36	21	68
100-160	25.5	13	50	36	21	68
200	25.5	13	50	36	21	68
250	-	-	-	36	21	68
315	-	-	-	36	21	68

6.11.3 Double seal types

6.11.3a Double back-to-back seal with Flowserve eccentric pumping annulus circulation (limited to a short T2100 outboard and a EN 12757 'K' type rubber bellow seal inboard)

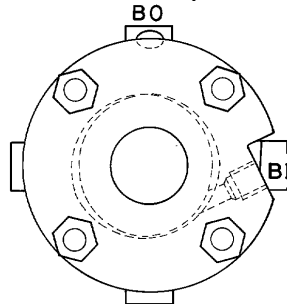

BO - Rp ¼ in. barrier liquid outlet
 BI - Rp ¼ in. barrier liquid inlet

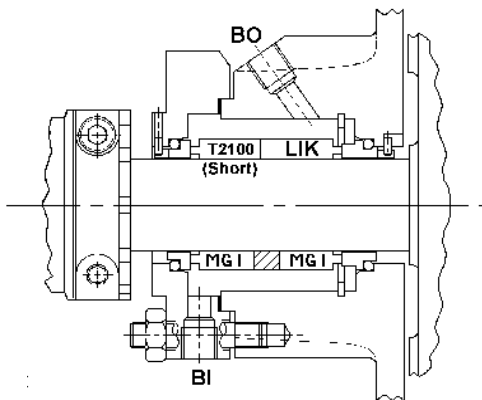

6.11.4 Cartridge seal types

6.11.4a Compact dual or gas buffer/barrier cartridge seal

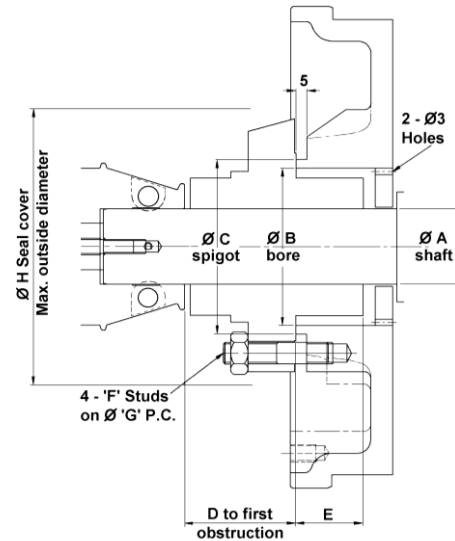

	Stub shaft A	Stub shaft B
A	35 mm	45 mm
B	61.5 mm	73 mm
C	81 mm +0.0/-0.05 mm	97 mm +0.0/-0.05 mm
D	55 mm	60 mm
E	34 mm	34 mm
F	M 10	M 12
G	98 mm	117 mm
H	130 mm	164 mm

6.11.4b Compact cartridge seal

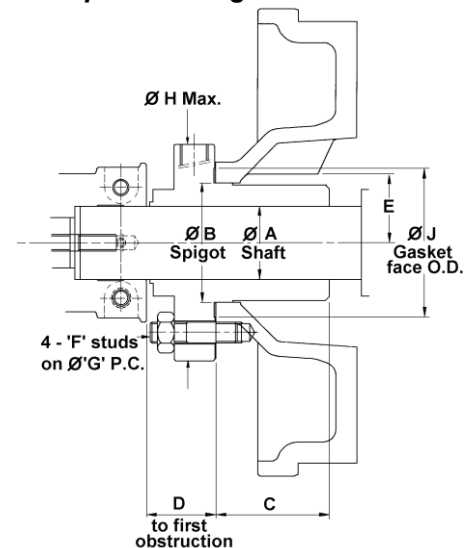

Stub shaft	A	B	B option	C	D	E	F	G	H max	J
A	35 mm	62 mm -0.05/+0.0 mm	51 mm -0.0/+0.2 mm	54 mm	33 mm	33 mm	M 10	86 mm	130 mm	76 mm
B & C	45 mm	74 mm -0.05/+0.0 mm	70 mm -0.0/+0.2 mm	60 mm	36.5 mm	39.5 mm	M 12	100 mm	164 mm	86 mm

7 FAULTS; CAUSES AND REMEDIES

FAULT SYMPTOM

Pump overheats and seizes																																																																																																								
↓	Bearings have short life																																																																																																							
↓	Pump vibrates or is noisy																																																																																																							
↓	Mechanical seal has short life																																																																																																							
↓	Mechanical seal leaks excessively																																																																																																							
↓	Pump requires excessive power																																																																																																							
↓	Pump loses prime after starting																																																																																																							
↓	Insufficient pressure developed																																																																																																							
↓	Insufficient capacity delivered																																																																																																							
↓	Pump does not deliver liquid																																																																																																							
												<table border="1"> <thead> <tr> <th>PROBABLE CAUSES</th> <th>POSSIBLE REMEDIES</th> </tr> </thead> <tbody> <tr> <td colspan="2" style="text-align: center;">A. System troubles</td> </tr> <tr> <td>● Pump not primed or filled with liquid.</td> <td rowspan="2">Check complete filling. Vent and/or prime.</td> </tr> <tr> <td>● Pump or suction pipe not completely filled with liquid.</td> </tr> <tr> <td>● Suction lift too high.</td> <td rowspan="2">Check $NPSH_A > NPSH_R$, proper submergence, losses at strainers and fittings.</td> </tr> <tr> <td>● Insufficient margin between suction pressure and vapour pressure.</td> </tr> <tr> <td>● Excessive amount of air or gas in liquid.</td> <td>Check and purge pipes and system.</td> </tr> <tr> <td>● Air or vapour pocket in suction line.</td> <td>Check suction line design for vapour pockets.</td> </tr> <tr> <td>● Air leaks into suction line.</td> <td>Check suction pipe is airtight.</td> </tr> <tr> <td>● Air leaks into pump through mechanical seal, sleeve joints, casing joint or pipe lugs.</td> <td>Check and replace faulty parts. CONSULT FLOWSERVE.</td> </tr> <tr> <td>● Foot valve too small.</td> <td>Investigate replacing the foot valve.</td> </tr> <tr> <td>● Foot valve partially clogged.</td> <td>Clean foot valve.</td> </tr> <tr> <td>● Inlet of suction pipe insufficiently submerged.</td> <td>Check out system design.</td> </tr> <tr> <td>● Speed too low.</td> <td>CONSULT FLOWSERVE.</td> </tr> <tr> <td>● Speed too high.</td> <td>CONSULT FLOWSERVE.</td> </tr> <tr> <td>● Total head of system higher than differential head of pump.</td> <td rowspan="2">Check system losses. Remedy or CONSULT FLOWSERVE.</td> </tr> <tr> <td>● Total head of system lower than pump design head.</td> </tr> <tr> <td>● Specific gravity of liquid different from design.</td> <td rowspan="2">Check and CONSULT FLOWSERVE.</td> </tr> <tr> <td>● Viscosity of liquid differs from that for which designed.</td> </tr> <tr> <td>● Operation at very low capacity.</td> <td>Measure value and check minimum permitted. Remedy or CONSULT FLOWSERVE.</td> </tr> <tr> <td>● Operation at high capacity.</td> <td>Measure value and check maximum permitted. Remedy or CONSULT FLOWSERVE.</td> </tr> <tr> <td colspan="12" style="text-align: center;">B. Mechanical troubles</td> </tr> <tr> <td>●</td> <td>●</td> <td>●</td> <td>●</td> <td>●</td> <td>●</td> <td></td> <td></td> <td></td> <td></td> <td></td> <td></td> <td>Misalignment due to pipe strain.</td> <td>Check the flange connections and eliminate strains using elastic couplings or a method permitted.</td> </tr> <tr> <td></td> <td>●</td> <td></td> <td></td> <td></td> <td></td> <td></td> <td></td> <td></td> <td></td> <td></td> <td></td> <td>Improperly designed foundation.</td> <td>Check setting of baseplate: tighten, adjust, grout base as required.</td> </tr> <tr> <td>●</td> <td>●</td> <td>●</td> <td>●</td> <td>●</td> <td>●</td> <td></td> <td></td> <td></td> <td></td> <td></td> <td></td> <td>Shaft bent.</td> <td>Check shaft runouts are within acceptable values. CONSULT FLOWSERVE.</td> </tr> </tbody> </table>	PROBABLE CAUSES	POSSIBLE REMEDIES	A. System troubles		● Pump not primed or filled with liquid.	Check complete filling. Vent and/or prime.	● Pump or suction pipe not completely filled with liquid.	● Suction lift too high.	Check $NPSH_A > NPSH_R$, proper submergence, losses at strainers and fittings.	● Insufficient margin between suction pressure and vapour pressure.	● Excessive amount of air or gas in liquid.	Check and purge pipes and system.	● Air or vapour pocket in suction line.	Check suction line design for vapour pockets.	● Air leaks into suction line.	Check suction pipe is airtight.	● Air leaks into pump through mechanical seal, sleeve joints, casing joint or pipe lugs.	Check and replace faulty parts. CONSULT FLOWSERVE.	● Foot valve too small.	Investigate replacing the foot valve.	● Foot valve partially clogged.	Clean foot valve.	● Inlet of suction pipe insufficiently submerged.	Check out system design.	● Speed too low.	CONSULT FLOWSERVE.	● Speed too high.	CONSULT FLOWSERVE.	● Total head of system higher than differential head of pump.	Check system losses. Remedy or CONSULT FLOWSERVE.	● Total head of system lower than pump design head.	● Specific gravity of liquid different from design.	Check and CONSULT FLOWSERVE.	● Viscosity of liquid differs from that for which designed.	● Operation at very low capacity.	Measure value and check minimum permitted. Remedy or CONSULT FLOWSERVE.	● Operation at high capacity.	Measure value and check maximum permitted. Remedy or CONSULT FLOWSERVE.	B. Mechanical troubles												●	●	●	●	●	●							Misalignment due to pipe strain.	Check the flange connections and eliminate strains using elastic couplings or a method permitted.		●											Improperly designed foundation.	Check setting of baseplate: tighten, adjust, grout base as required.	●	●	●	●	●	●							Shaft bent.	Check shaft runouts are within acceptable values. CONSULT FLOWSERVE.
PROBABLE CAUSES	POSSIBLE REMEDIES																																																																																																							
A. System troubles																																																																																																								
● Pump not primed or filled with liquid.	Check complete filling. Vent and/or prime.																																																																																																							
● Pump or suction pipe not completely filled with liquid.																																																																																																								
● Suction lift too high.	Check $NPSH_A > NPSH_R$, proper submergence, losses at strainers and fittings.																																																																																																							
● Insufficient margin between suction pressure and vapour pressure.																																																																																																								
● Excessive amount of air or gas in liquid.	Check and purge pipes and system.																																																																																																							
● Air or vapour pocket in suction line.	Check suction line design for vapour pockets.																																																																																																							
● Air leaks into suction line.	Check suction pipe is airtight.																																																																																																							
● Air leaks into pump through mechanical seal, sleeve joints, casing joint or pipe lugs.	Check and replace faulty parts. CONSULT FLOWSERVE.																																																																																																							
● Foot valve too small.	Investigate replacing the foot valve.																																																																																																							
● Foot valve partially clogged.	Clean foot valve.																																																																																																							
● Inlet of suction pipe insufficiently submerged.	Check out system design.																																																																																																							
● Speed too low.	CONSULT FLOWSERVE.																																																																																																							
● Speed too high.	CONSULT FLOWSERVE.																																																																																																							
● Total head of system higher than differential head of pump.	Check system losses. Remedy or CONSULT FLOWSERVE.																																																																																																							
● Total head of system lower than pump design head.																																																																																																								
● Specific gravity of liquid different from design.	Check and CONSULT FLOWSERVE.																																																																																																							
● Viscosity of liquid differs from that for which designed.																																																																																																								
● Operation at very low capacity.	Measure value and check minimum permitted. Remedy or CONSULT FLOWSERVE.																																																																																																							
● Operation at high capacity.	Measure value and check maximum permitted. Remedy or CONSULT FLOWSERVE.																																																																																																							
B. Mechanical troubles																																																																																																								
●	●	●	●	●	●							Misalignment due to pipe strain.	Check the flange connections and eliminate strains using elastic couplings or a method permitted.																																																																																											
	●											Improperly designed foundation.	Check setting of baseplate: tighten, adjust, grout base as required.																																																																																											
●	●	●	●	●	●							Shaft bent.	Check shaft runouts are within acceptable values. CONSULT FLOWSERVE.																																																																																											

FAULT SYMPTOM

Pump overheats and seizes											
↓	Bearings have short life										
↓	↓	Pump vibrates or is noisy									
↓	↓	↓	Mechanical seal has short life								
↓	↓	↓	↓	Mechanical seal leaks excessively							
↓	↓	↓	↓	↓	Pump requires excessive power						
↓	↓	↓	↓	↓	↓	Pump loses prime after starting					
↓	↓	↓	↓	↓	↓	Insufficient pressure developed					
↓	↓	↓	↓	↓	↓	Insufficient capacity delivered					
↓	↓	↓	↓	↓	↓	Pump does not deliver liquid					
							PROBABLE CAUSES			POSSIBLE REMEDIES	
●	●	●			●					Rotating part rubbing on stationary part internally.	Check and CONSULT FLOWSERVE, if necessary.
●	●	●	●	●						Bearings worn	Replace bearings.
		●				●	●			Impeller damaged or eroded.	Replace or CONSULT FLOWSERVE for improved material selection.
		●	●							Stub shaft worn or scored or running off center.	Check and renew defective parts.
		●	●	●						Mechanical seal improperly installed.	Check alignment of faces or damaged parts and assembly method used.
		●	●	●						Incorrect type of mechanical seal for operating conditions.	CONSULT FLOWSERVE.
●	●	●	●	●						Shaft running off center because of worn bearings or misalignment.	Check misalignment and correct if necessary. If alignment satisfactory check bearings for excessive wear.
●	●	●	●	●						Impeller out of balance resulting in vibration.	Check and CONSULT FLOWSERVE.
		●	●	●						Abrasive solids in liquid pumped.	
		●	●							Internal misalignment of parts preventing seal ring and seat from mating properly.	
		●	●							Mechanical seal was run dry.	Check mechanical seal condition and source of dry running and repair.
		●	●							Internal misalignment due to improper repairs causing impeller to rub.	Check method of assembly, possible damage or state of cleanliness during assembly. Remedy or CONSULT FLOWSERVE, if necessary.
●	●	●								Excessive thrust caused by a mechanical failure inside the pump.	Check wear condition of impeller, its clearances and liquid passages.
	●	●								Damaged bearings due to contamination.	Check contamination source and replace damaged bearings.
C. Motor electrical problems											
		●		●	●	●				Wrong direction of rotation.	Reverse 2 phases at motor terminal box.
				●		●				Motor running on 2 phases only.	Check supply and fuses.
	●	●						●		Motor running too slow.	Check motor terminal box connections and voltage.
				●	●	●				Motor incorrectly wired.	Check motor terminal box connections, refer to motor instructions.

8 PARTS LISTS AND DRAWINGS

8.1 Mark 3 ISO close coupled

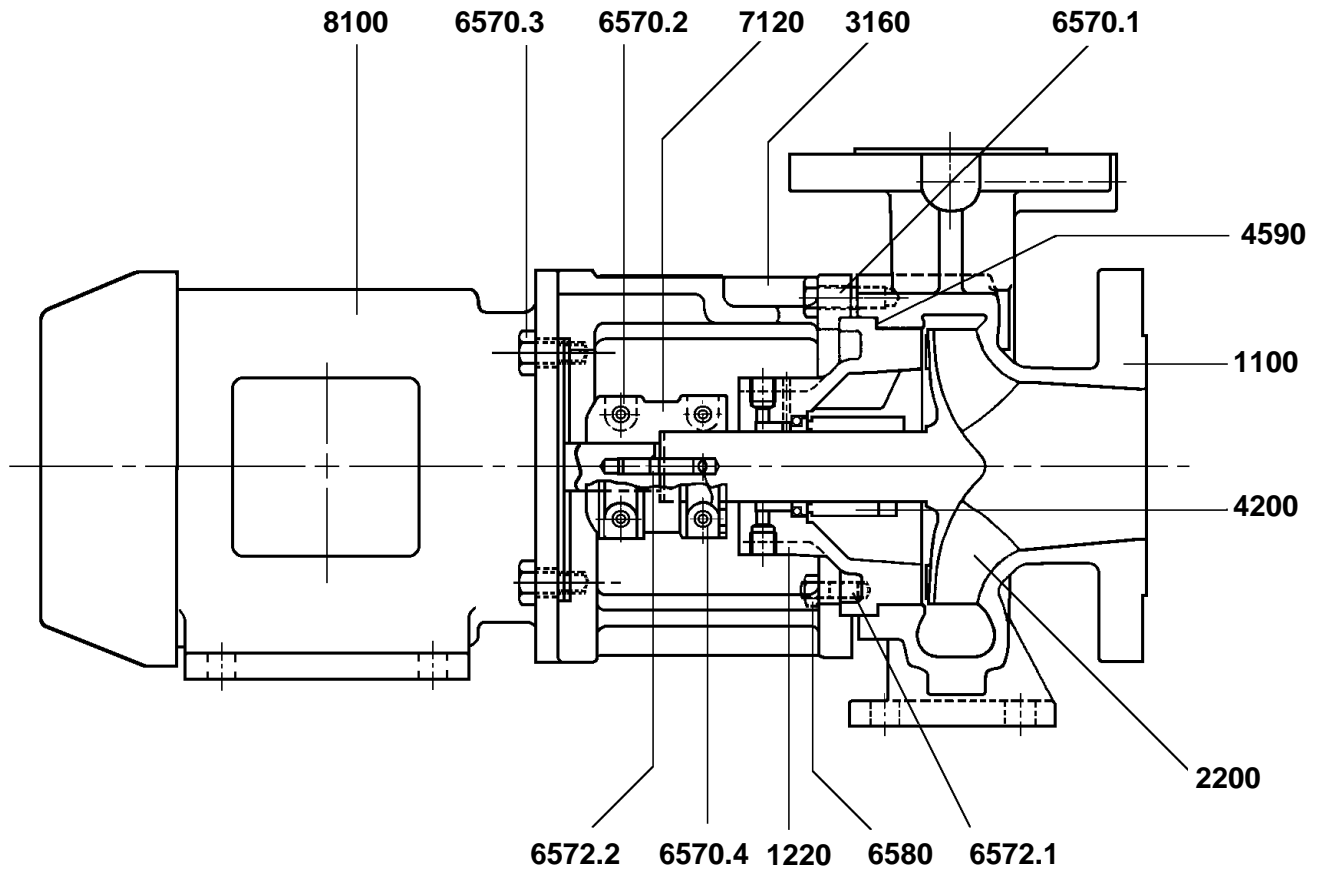

Item	Description
1100	Casing
2200	Impeller
3160	Motor pedestal
4200	Mechanical seal
1220	Cover
4590	Gasket
7120	Muff coupling, split
8100	Motor
6570.1	Screw
6570.2	Screw
6570.3	Screw
6570.4	Screw
6580	Nut
6572.1	Stud
6572.2	Stud
7450	Guard
2510	Distance ring

8.2 Mark 3 ISO close coupled recessed impeller

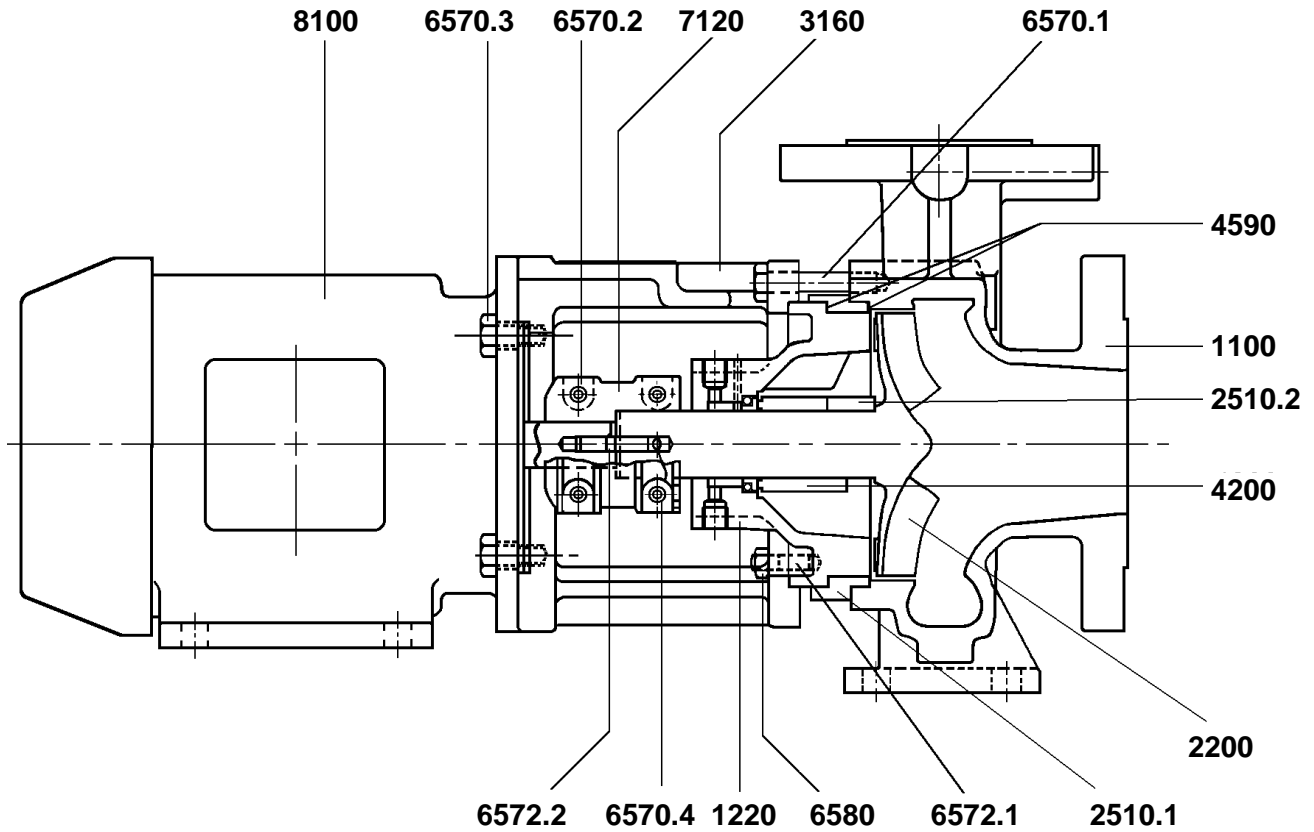

Item	Description
1100	Casing
2200	Impeller
2510.1	Distance ring
2510.2	Distance ring
3160	Motor pedestal
4200	Mechanical seal
1220	Cover
4590	Gasket
6569	Plug
7120	Muff coupling, split
8100	Motor
6570.1	Screw
6570.2	Screw
6570.3	Screw
6570.4	Screw
6580	Nut
6572.1	Stud
6572.2	Stud
7450	Guard

8.3 General arrangement drawing

The typical general arrangement drawing and any specific drawings required by the contract will be sent to the Purchaser separately unless the contract specifically calls for these to be included into the User Instructions. If required, copies of other drawings sent separately to the Purchaser should be obtained from the Purchaser and retained with these User Instructions.

9 CERTIFICATION

Certificates determined from the Contract requirements are provided with these Instructions where applicable. Examples are certificates for CE marking, ATEX marking etc. If required, copies of other certificates sent separately to the Purchaser should be obtained from the Purchaser for retention with these User Instructions.

10 OTHER RELEVANT DOCUMENTATION AND MANUALS

10.1 Supplementary User Instruction manuals

Supplementary instruction determined from the contract requirements for inclusion into User Instructions such as for a driver, instrumentation, controller, sub-driver, seals, sealant system, mounting component etc are included under this section. If further copies of these are required they should be obtained from the purchaser for retention with these User Instructions.

Where any pre-printed set of User Instructions are used, and satisfactory quality can be maintained only by avoiding copying these, they are included at the end of these User Instructions such as within a standard clear polymer software protection envelope.

10.2 Change notes

If any changes, agreed with Flowserve Pump Division, are made to the product after its supply, a record of the details should be maintained with these User Instructions.

10.3 Additional sources of information

Reference 1:

NPSH for Rotodynamic Pumps: a reference guide, Europump Guide No. 1, Europump & World Pumps, Elsevier Science, United Kingdom, 1999.

Reference 2:

Pumping Manual, 9th edition, T.C. Dickenson, Elsevier Advanced Technology, United Kingdom, 1995.

Reference 3:

Pump Handbook, 2nd edition, Igor J. Karassik et al, McGraw-Hill Inc., New York, 1993.

Reference 4:

ANSI/HI 1.1-1.5. Centrifugal Pumps - Nomenclature, Definitions, Application and Operation.

Reference 5:

ANSI B31.3 - Process Piping.

Reference 6:

ESA – Guidelines for Safe Seal Usage (Flanges and Gaskets).

Notes:

Notes:

Your Flowserve factory contact:

Flowserve Pumps
Flowserve GB Limited
Lowfield Works, Balderton
Newark, Notts NG24 3BU
United Kingdom

Telephone (24 hours) +44 1636 494 600
Sales & Admin Fax +44 1636 705 991
Repair & Service Fax +44 1636 494 833

Email newarksales@flowserve.com

Your local Flowserve representative:

Flowserve Pompes SAS
13 rue Maurice Trintignant
CS10001, 72234 Arnage Cedex
France

Telephone (24 hours) +33 43 40 57 75
Sales & Admin Fax +33 43 40 57 57
Repair & Service Fax +33 43 40 58 17

To find your local Flowserve representative please
use the Sales Support Locator System found at
www.flowserve.com

**FLOWSERVE REGIONAL
SALES OFFICES:****USA and Canada**

Flowserve Corporation
5215 North O'Connor Blvd.,
Suite 2300
Irving, Texas 75039-5421, USA
Telephone +1 972 443 6500
Fax +1 972 443 6800

Europe, Middle East, Africa

Flowserve Worthington S.r.L.
Via Rossini 90/92
20033 Desio (Milan), Italy
Telephone +39 0362 6121
Fax +39 0362 303 396

Latin America and Caribbean

Flowserve Corporation
6840 Wynnwood Lane
Houston, Texas 77008, USA
Telephone +1 713 803 4434
Fax +1 713 803 4497

Asia Pacific

Flowserve Pte. Ltd
10 Tuas Loop
Singapore 637345
Telephone: +65 6771 0600
Telefax: +65 6862 2329