



# USER INSTRUCTIONS

## INNOMAG<sup>®</sup> U-MAG<sup>™</sup>

Horizontal close coupled, fluoropolymer lined, sealless chemical process pumps

**Installation**  
**Operation**  
**Maintenance**

PCN= 26999990 10-14 (E). *Original instructions.*

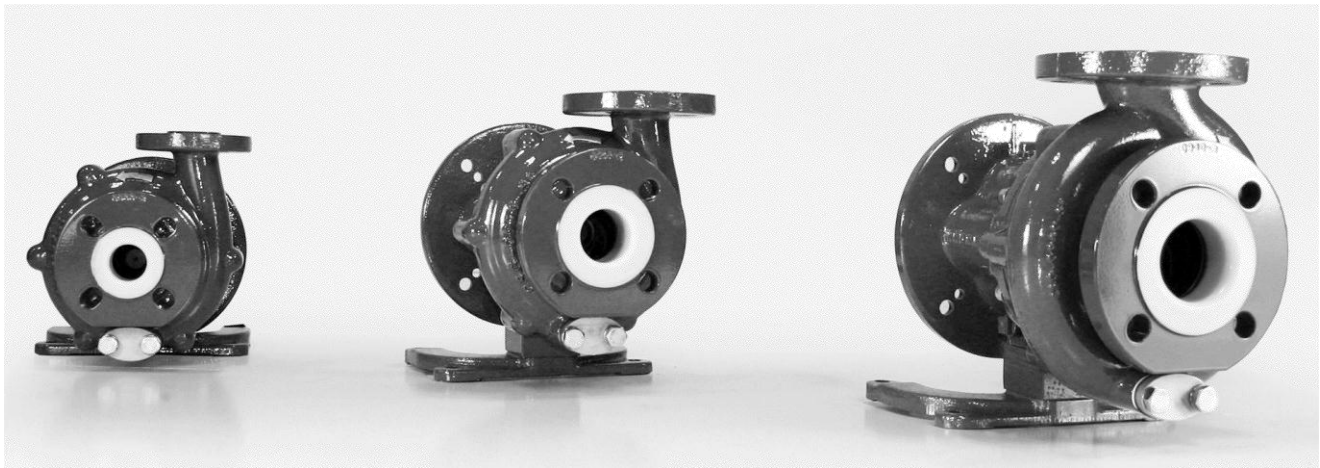

***These instructions must be read prior to installing, operating, using and maintaining this equipment.***

***Experience In Motion***

<u>TABLE OF CONTENTS</u>		Page	Page
1	INTRODUCTION AND SAFETY .....	4	
1.1	General .....	4	6.12 Drive End Disassembly .....
1.2	CE marking and approvals .....	4	6.13 Drive End Assembly .....
1.3	Disclaimer .....	4	6.14 Wet / Drive End Assembly .....
1.4	Copyright.....	4	6.15 Gasoline Engine .....
1.5	Duty conditions .....	4	7 Troubleshooting .....
1.6	Safety.....	5	7.1 Faults, causes and remedies .....
1.7	Nameplate and safety labels .....	9	8 PARTS LISTS AND DRAWINGS.....
1.8	Specific machine performance.....	9	8.1 Sectional drawing .....
1.9	Noise level .....	9	8.2 Parts interchangeability .....
2	TRANSPORT AND STORAGE .....	9	8.3 General arrangement drawing.....
2.1	Consignment receipt and unpacking .....	9	9 CERTIFICATION .....
2.2	Handling.....	10	10 OTHER RELEVANT DOCUMENTATION AND
2.3	Lifting.....	10	MANUALS .....
2.4	Storage.....	11	10.1 Supplementary User Instruction manuals ..
2.5	Recycling and end of product life.....	11	10.2 Change notes .....
3	DESCRIPTION .....	11	10.3 Additional sources of information .....
3.1	Configurations.....	11	
3.2	Nomenclature.....	11	
3.3	Nameplate.....	11	
3.4	Design of major parts.....	13	
3.5	Performance and operating limits .....	13	
4	INSTALLATION .....	14	
4.1	Location .....	14	
4.2	Part Assemblies .....	14	
4.3	Foundation .....	15	
4.4	Grouting .....	16	
4.5	Piping .....	17	
4.6	Electrical connections .....	18	
4.7	Protection systems.....	18	
4.8	Final checks .....	19	
5	COMMISSIONING, START-UP, OPERATION		
	AND SHUTDOWN .....	19	
5.1	Direction of rotation .....	19	
5.2	Priming and auxiliary supplies .....	20	
5.3	Starting the pump.....	20	
5.4	Running the pump.....	20	
5.5	Stopping and shutdown .....	20	
5.6	Hydraulic, mechanical and electrical duty ..	21	
6	MAINTENANCE .....	21	
6.1	General .....	21	
6.2	Maintenance schedule.....	22	
6.3	Spare parts.....	23	
6.4	Tools required .....	23	
6.5	Fastener torques.....	23	
6.6	Disassembly.....	24	
6.7	Examination of parts .....	25	
6.8	Casing [1100] Repair .....	26	
6.9	Containment Shell [3500] Repair .....	27	
6.10	Impeller Repair.....	27	
6.11	Wet End Assembly.....	29	

**INDEX**

	Page		Page
Additional information (10.3).....	39	Noise level (1.9).....	9
Assembly (6.11.2).....	29	Nozzle loads (4.5.4).....	18
ATEX marking (1.6.4.2).....	7	Operating limits (3.5.1).....	13
CE marking and approvals (1.2).....	4	Ordering spare parts (6.3.1).....	23
Certification (9).....	39	Part assemblies (4.2).....	14
Change notes (10.2).....	39	Parts interchangeability (8.2).....	38
Commissioning and operation (5).....	19	Parts lists (8).....	37
Compliance, ATEX (1.6.4.1).....	7	Performance (3.5).....	13
Configurations (3.1).....	11	Piping (4.5).....	17
Copyright (1.4).....	4	Priming and auxiliary supplies (5.2).....	20
Design of major parts (3.4).....	13	Protection systems (4.7).....	18
Direction of rotation (5.1).....	19	Qualification and training (1.6.2).....	5
Disassembly (6.6).....	24	Receipt and unpacking (2.1).....	9
Disclaimer (1.3).....	4	Recommended spares (6.3.3).....	23
Drawings (8).....	37	Recycling (2.5).....	11
Duty conditions (1.5).....	4	Replacement parts (6.3).....	23
Electrical connections (4.6).....	18	Running the pump (5.4).....	20
End of product life (2.5).....	11	Safety (1.6).....	5
Examination of parts (6.7).....	25	Safety action (1.6.3).....	5
Fastener torques (6.5).....	23	Safety markings (1.6.1).....	5
Faults, causes and remedies (7.1).....	34	Safety warnings (1).....	4
Final checks (4.8).....	19	Sectional drawing, general (8.1).....	37
Flange pressure rating (3.5.2).....	13	Sectional drawings (8).....	37
Foundation (4.3).....	15	Shaft alignment check (4.8).....	19
General (1.1).....	4	Sources (10.3).....	39
General arrangement drawing (8.3).....	39	Spare parts (6.3).....	23
General assembly drawings (8).....	37	Specific machine performance (1.8).....	9
Grouting (4.4).....	16	Starting the pump (5.3).....	20
Handling (2.2).....	10	Stilt mounted baseplate (4.3.3.1).....	15
Hydraulic, mechanical and electrical duty (5.6).....	21	Stop/start frequency (5.4.2).....	20
Inspection (6.7.2).....	25	Stopping and shutdown (5.5).....	20
Installation (4).....	14	Storage (2.4).....	11
Lifting (2.3).....	10	Storage of spares (6.3.2).....	23
Location (4.1).....	14	Supplementary user instructions (10.1).....	39
Maintenance (6).....	21	ThermicSense (4.7.1.3).....	19
Maintenance schedule (6.2).....	22	Tools required (6.4).....	23
Name nomenclature (3.2).....	11	Transport and storage (2).....	9
Nameplate (1.7.1 and 3.3).....	9, 11	Troubleshooting (7).....	34

## 1 INTRODUCTION AND SAFETY

### 1.1 General

 ***These instructions must always be kept close to the product's operating location or directly with the product.***

Flowserve products are designed, developed and manufactured with state-of-the-art technologies in modern facilities. The unit is produced with great care and commitment to continuous quality control, utilizing sophisticated quality techniques and safety requirements.

Flowserve is committed to continuous quality improvement and being at service for any further information about the product in its installation and operation or about its support products, repair and diagnostic services.

These instructions are intended to facilitate familiarization with the product and its permitted use. Operating the product in compliance with these instructions is important to help ensure reliability in service and avoid risks. The instructions may not take into account local regulations; ensure such regulations are observed by all, including those installing the product. Always coordinate repair activity with operations personnel, and follow all plant safety requirements and applicable safety and health laws and regulations.

 ***These instructions must be read prior to installing, operating, using and maintaining the equipment in any region worldwide. The equipment must not be put into service until all the conditions relating to safety, noted in the instructions, have been met. Failure to follow and apply the present user instructions is considered to be misuse. Personal injury, product damage, delay or failure caused by misuse are not covered by the Flowserve warranty.***

### 1.2 CE marking and approvals

It is a legal requirement that machinery and equipment put into service within certain regions of the world shall conform with the applicable CE Marking Directives covering Machinery and, where applicable, Low Voltage Equipment, Electromagnetic Compatibility (EMC), Pressure Equipment Directive (PED) and Equipment for Potentially Explosive Atmospheres (ATEX).

Where applicable, the Directives and any additional Approvals, cover important safety aspects relating to machinery and equipment and the satisfactory provision

of technical documents and safety instructions. Where applicable this document incorporates information relevant to these Directives and Approvals.

To confirm the Approvals applying and if the product is CE marked, check the serial number plate markings and the Certification. (See section 9, *Certification*.)

### 1.3 Disclaimer

***Information in these User Instructions is believed to be complete and reliable. However, in spite of all of the efforts of Flowserve Corporation to provide comprehensive instructions, good engineering and safety practice should always be used.***

Flowserve manufactures products to exacting International Quality Management System Standards as certified and audited by external Quality Assurance organizations. Genuine parts and accessories have been designed, tested and incorporated into the products to help ensure their continued product quality and performance in use. As Flowserve cannot test parts and accessories sourced from other vendors the incorrect incorporation of such parts and accessories may adversely affect the performance and safety features of the products. The failure to properly select, install or use authorized Flowserve parts and accessories is considered to be misuse. Damage or failure caused by misuse is not covered by the Flowserve warranty. In addition, any modification of Flowserve products or removal of original components may impair the safety of these products in their use.

### 1.4 Copyright

All rights reserved. No part of these instructions may be reproduced, stored in a retrieval system or transmitted in any form or by any means without prior permission of Flowserve.

### 1.5 Duty conditions

This product has been selected to meet the specifications of your purchase order. The acknowledgement of these conditions has been sent separately to the Purchaser. A copy should be kept with these instructions.

 ***The product must not be operated beyond the parameters specified for the application. If there is any doubt as to the suitability of the product for the application intended, contact Flowserve for advice, quoting the serial number.***

If the conditions of service on your purchase order are going to be changed (for example liquid pumped, temperature or duty) it is requested that the user seeks the written agreement of Flowserve before start up.

## 1.6 Safety

### 1.6.1 Summary of safety markings

These User Instructions contain specific safety markings where non-observance of an instruction would cause hazards. The specific safety markings are:



**DANGER** This symbol indicates electrical safety instructions where non-compliance will involve a high risk to personal safety or the loss of life.



This symbol indicates safety instructions where non-compliance would affect personal safety and could result in loss of life.



This symbol indicates “hazardous and toxic fluid” safety instructions where non-compliance would affect personal safety and could result in loss of life.



This symbol indicates “Pacemaker” safety instructions where non-compliance would affect personal safety and could result in loss of life.



**CAUTION** This symbol indicates safety instructions where non-compliance will involve some risk to safe operation and personal safety and would damage the equipment or property.



This symbol indicates explosive atmosphere zone marking according to ATEX. It is used in safety instructions where non-compliance in the hazardous area would cause the risk of an explosion.



This symbol is used in safety instructions to remind not to rub non-metallic surfaces with a dry cloth; ensure the cloth is damp. It is used in safety instructions where non-compliance in the hazardous area would cause the risk of an explosion.

**Note:**

This sign is not a safety symbol but indicates an important instruction in the assembly process.

### 1.6.2 Personnel qualification and training

All personnel involved in the operation, installation, inspection and maintenance of the unit must be qualified to carry out the work involved. If the personnel in question do not already possess the necessary knowledge and skill, appropriate training and instruction must be provided. If required, the operator may

commission the manufacturer/supplier to provide applicable training.

Always coordinate repair activity with operations and health and safety personnel. Follow all plant safety requirements and applicable safety and health laws and regulations.

### 1.6.3 Safety action

***This is a summary of conditions and actions to help prevent injury to personnel and damage to the environment and to equipment. For products used in potentially explosive atmospheres section 1.6.4 also applies.***



U-MAG™ pumps contain extremely strong permanent neodymium magnets which could affect the functioning of pacemakers and implanted heart defibrillators. If you wear these devices keep sufficient distance to magnets.



**CAUTION** Magnets produce a far-reaching, strong magnetic field. They can damage laptops, computer hard drives, credit and ATM cards, data storage media, mechanical watches, hearing aids and speakers. Keep magnets away from devices and objects that could be damaged by strong magnetic fields.



**DANGER** NEVER DO MAINTENANCE WORK WHEN THE UNIT IS CONNECTED TO POWER



**GUARDS MUST NOT BE REMOVED WHILE THE PUMP IS OPERATIONAL**



**DRAIN THE PUMP AND ISOLATE PIPEWORK BEFORE DISMANTLING THE PUMP**  
The appropriate safety precautions should be taken where the pumped liquids are hazardous.



**NEVER** use heat (risk of explosion) to disassemble any portion of the pump.



**HIGH TEMPERATURES** may be present. Pump surface temperature is directly related to the temperature of the working fluid. Never operate pump above the rated temperature of 121°C (250°F).



**HANDLING COMPONENTS**

Many precision parts have sharp corners and the wearing of appropriate safety gloves and equipment is required when handling these components. To lift heavy pieces above 25 kg (55 lb.) use a crane appropriate for the mass and in accordance with current local regulations.

**Personal Protection Equipment** suitable for the conditions and environment must be worn at all times.

**THERMAL SHOCK**

Rapid changes in the temperature of the liquid within the pump can cause thermal shock, which can result in damage or breakage of components and should be avoided.

**HOT (and cold) PARTS**

If hot or freezing components or auxiliary heating supplies can present a danger to operators and persons entering the immediate area action must be taken to avoid accidental contact. If complete protection is not possible, the machine access must be limited to maintenance staff only, with clear visual warnings and indicators to those entering the immediate area.

***If the temperature is greater than 80 °C (175 °F) or below -5 °C (23 °F) in a restricted zone, or exceeds local regulations, action as above shall be taken.***

**HAZARDOUS LIQUIDS**

When the pump is handling hazardous liquids care must be taken to avoid exposure to the liquid by appropriate siting of the pump, limiting personnel access and by operator training. If the liquid is flammable and/or explosive, strict safety procedures must be applied.

**CAUTION** **PREVENT EXCESSIVE EXTERNAL PIPE LOAD.** Do not use pump as a support for piping. Do not mount expansion joints, unless allowed by Flowserve in writing, so that their force, due to internal pressure, acts on the pump flange.

Never loosen flange connection while system is under pressure.

**CAUTION** Always make certain pressure gages, indicating lights and safety devices are working.

**ALWAYS** know the **EMERGENCY STOP** location for the pump.

**CAUTION** **NEVER RUN THE PUMP DRY.** Use diamond-like-coated (DLC) parts for additional protection from dry running. DLC does not guarantee dry run protection.

Never start this pump without proper prime (casing must be full of liquid).

**CAUTION** **START THE PUMP WITH THE DISCHARGE VALVE PARTLY OPENED** (Unless otherwise instructed at a specific point in the User Instructions.) This is recommended to minimize the risk of overloading and damaging the pump or motor at full or zero flow. Pumps may be started with the valve further open only on installations where this situation cannot occur. The pump outlet control valve may need to be adjusted to comply with the duty following the run-up process. (See section 5, *Commissioning start-up, operation and shutdown.*)

**SUCTION VALVES TO BE FULLY OPEN WHEN PUMP IS RUNNING**

Running the pump at zero flow or below the recommended minimum flow continuously will cause damage to the pump. Never operate this pump with the suction and / or discharge valve closed as this may lead to high surface temperatures.

**CAUTION** The direction of rotation is clockwise when viewed from the motor end. Rotation of the motor must be checked prior to starting the pump according to section 5.1.

**CAUTION** **DO NOT RUN THE PUMP AT ABNORMALLY HIGH OR LOW FLOW RATES** Operating at a flow rate higher than normal or at a flow rate with no back pressure on the pump may overload the motor and cause cavitation. Low flow rates may cause a reduction in pump/bearing life, overheating of the pump, instability and cavitation/vibration.

**CAUTION** **NEVER EXCEED THE MAXIMUM DESIGN PRESSURE (MDP) AT THE TEMPERATURE SHOWN ON THE PUMP NAMEPLATE AND INCLUDED IN SECTION 3.5.2.**

**CAUTION** Driver may overload and de-couple if pumpage specific gravity is greater than originally assumed. Prolonged running while de-coupled will damage driver and impeller magnets.

Decoupling the pump may lead to increased surface temperatures.

**CAUTION** Never change conditions of service without approval of authorized Flowserve distributor.

Excessive amounts of dust collected on the pump housing may lead to an increase in surface temperature, possibly exceeding temperature limits. May require regular cleaning.

Always have this service manual available during any installation or maintenance.

**1.6.4 Products used in potentially explosive atmospheres**

- Measures are required to:
- Avoid excess temperature
  - Prevent build up of explosive mixtures
  - Prevent the generation of sparks
  - Prevent leakages
  - Maintain the pump to avoid hazard

The following instructions for pumps and pump units when installed in potentially explosive atmospheres must be followed to help ensure explosion protection. For ATEX, both electrical and non-electrical equipment must meet the requirements of European Directive 2014/34/EU (previously 94/9/EC which remains valid until April 20<sup>th</sup> 2016 during the transition). Always observe the regional legal Ex requirements eg Ex electrical items outside the EU may be required certified to other than ATEX eg IECEx, UL.

**1.6.4.1 Scope of compliance**

Use equipment only in the zone for which it is appropriate. Always check that the driver and pump equipment are suitably rated and/or certified for the classification of the specific atmosphere in which they are to be installed.

Where Flowserve has supplied only the bare shaft pump, the Ex rating applies only to the pump. The party responsible for assembling the ATEX pump set shall select the coupling, driver and any additional equipment, with the necessary CE Certificate/ Declaration of Conformity establishing it is suitable for the area in which it is to be installed.

The output from a variable frequency drive (VFD) can cause additional heating effects in the motor and so, for pumps sets with a VFD, the ATEX Certification for the motor must state that it covers the situation where electrical supply is from the VFD. This particular requirement still applies even if the VFD is in a safe area.

**1.6.4.2 Marking**

An example of ATEX equipment marking is shown below. The actual classification of the pump will be engraved on the nameplate.

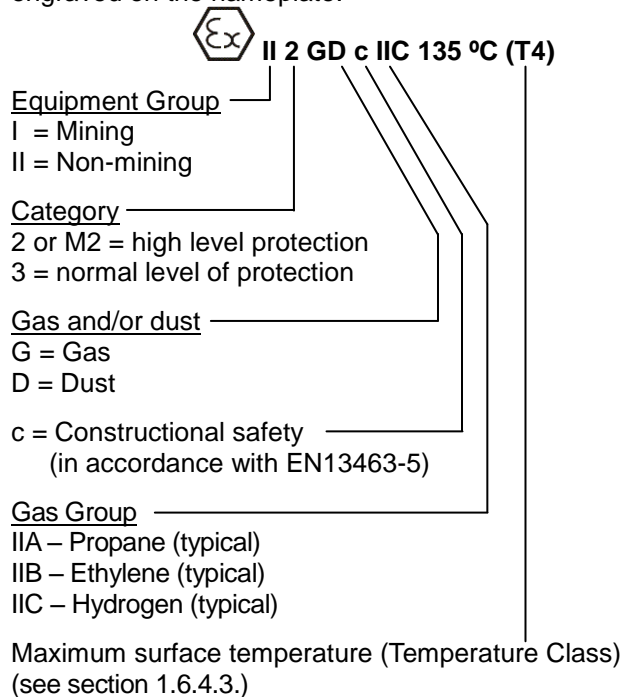

**1.6.4.3 Avoiding excessive surface temperatures**

ENSURE THE EQUIPMENT TEMPERATURE CLASS IS SUITABLE FOR THE HAZARD ZONE

Pumps have a temperature class as stated in the ATEX Ex rating on the nameplate. These are based on a maximum ambient of 40 °C (104 °F); refer to Flowserve for higher ambient temperatures.

The surface temperature on the pump is influenced by the temperature of the liquid handled. The maximum permissible liquid temperature depends on the ATEX temperature class and must not exceed the values in the table that follows.

**Maximum permitted liquid temperature for pumps**

Temperature class to EN13463-1	Maximum surface temperature permitted	Temperature limit of liquid handled
T6	85 °C (185 °F)	65 °C (149 °F) *
T5	100 °C (212 °F)	80 °C (176 °F) *
T4	135 °C (275 °F)	115 °C (239 °F) *
T3	200 °C (392 °F)	180 °C (356 °F) *
T2	300 °C (572 °F)	275 °C (527 °F) *
T1	450 °C (842 °F)	400 °C (752 °F) *

\* The table only takes the ATEX temperature class into consideration. Pump design or material, as well as component design or material, may further limit the maximum working temperature of the liquid.

The temperature rise at the bearings and due to the minimum permitted flow rate is taken into account in the temperatures stated.

**The operator is responsible to ensure that the specified maximum liquid temperature is not exceeded.**

Temperature classification “Tx” is used when the liquid temperature varies and when the pump is required to be used in differently classified potentially explosive atmospheres. In this case the user is responsible for ensuring that the pump surface temperature does not exceed that permitted in its actual installed location.

Avoid mechanical, hydraulic or electrical overload by using motor overload trips, temperature monitors and/or a power monitor and make routine vibration monitoring checks.

In dirty or dusty environments, make regular checks and remove dirt from areas around close clearances, bearing housings and motors.

Where there is any risk of the pump being run against a closed valve generating high liquid and casing external surface temperatures fit an external surface temperature protection device.

**1.6.4.4 Preventing the build-up of explosive mixtures**



ENSURE THE PUMP IS PROPERLY FILLED AND DOES NOT RUN DRY

Ensure the pump and relevant suction and discharge pipeline system is totally filled with liquid at all times during the pump operation, so that an explosive atmosphere is prevented.

If the operation of the system cannot avoid this condition, fit an appropriate dry run protection device (for example liquid detection or a power monitor).

To avoid potential hazards from fugitive emissions of vapor or gas to atmosphere the surrounding area must be well ventilated.

**1.6.4.5 Preventing sparks**



To avoid the potential hazard from random induced current generating a spark, the baseplate must be properly grounded.



Avoid electrostatic charge: do not rub non-metallic surfaces with a dry cloth; ensure cloth is damp.

**Additional requirement for metallic pumps on non-metallic baseplates**

When metallic components are fitted on a non-metallic baseplate they must be individually earthed.

If so equipped, to prevent a potential hazard from mechanical contact, the coupling guard must be non-sparking. For ATEX the coupling must be selected to comply with European Directive 2014/34/EU (previously 94/9/EC which remains valid until April 20<sup>th</sup> 2016 during the transition). Correct coupling alignment must be maintained.

**1.6.4.6 Preventing leakage**



The pump must only be used to handle liquids for which it has been approved to have the correct corrosion resistance.

Avoid entrapment of liquid in the pump and associated piping due to closing of suction and discharge valves, which could cause dangerous excessive pressures to occur if there is heat input to the liquid. This can occur if the pump is stationary or running.

Bursting of liquid containing parts due to freezing must be avoided by draining or protecting the pump and ancillary systems.

If leakage of liquid to atmosphere can result in a hazard, install a liquid detection device or secondary containment.

**1.6.4.7 Maintenance to avoid the hazard**



CORRECT MAINTENANCE IS REQUIRED TO AVOID POTENTIAL HAZARDS WHICH GIVE A RISK OF EXPLOSION

**The responsibility for compliance with maintenance instructions is with the plant operator.**

To avoid potential explosion hazards during maintenance, the tools, cleaning and painting materials used must not give rise to sparking or adversely affect the ambient conditions. Where there is a risk from such tools or materials, maintenance must be conducted in a safe area.

It is recommended that a maintenance plan and schedule is adopted. (See section 6, *Maintenance*.)



## 1.7 Nameplate and safety labels

### 1.7.1 Nameplate

For details of nameplate, see the *Declaration of Conformity*, or separate documentation included with these User Instructions.

### 1.7.2 Safety labels

**WARNING**

J218JZ260

ESSENTIAL PROCEDURES BEFORE STARTING:

INSTALL AND OPERATE EQUIPMENT IN ACCORDANCE WITH THE INSTRUCTION MANUAL SUPPLIED SEPARATELY.

ENSURE GUARDS ARE SECURELY IN PLACE.

ENSURE CORRECT DIRECTION OF ROTATION.

ENSURE ALL EXTERNAL CONNECTIONS TO THE PUMP / SHAFT SEALING AND DRIVER ARE CONNECTED AND OPERATIONAL.

FULLY PRIME UNIT AND SYSTEM. DO NOT RUN UNIT DRY.

FAILURE TO FOLLOW THESE PROCEDURES MAY RESULT IN PERSONAL INJURY AND / OR EQUIPMENT DAMAGE

---

J218JZ265

ENSURE CORRECT DRIVER DIRECTION OF ROTATION WITH COUPLING ELEMENT / PINS REMOVED; OTHERWISE SERIOUS DAMAGE MAY RESULT.

VERIFIER LE SENS CORRECT DE ROTATION DU MOTEUR. POMPE DESACCOUPLEE / ENTRETOISE DEMONTEE. NE PAS SUIVRE CETTE RECOMMANDATION PEUT CONDUIRE A DE GRAVES DOMMAGES POUR LA POMPE

KONTROLLE VORGESCHRIEBENER DREHRICHTUNG ! HIERZU KUPPLUNGSSWISCHENSTÜCK / KUPPLUNGSBOLZEN ENTFERNEN. ANDERENFALLS ERNSTHAFTE SCHÄDEN !

ZORG VOOR JUISTE ROTATIERICHTING VAN DRIJFAS WAARBIJ DE KOPPELELEMENTEN / PENNEN VERWIJDERD ZIJN. VERZUM KAN ERNSTIGE SCHADE TOT GEVOLG HEBBEN.

J218/268

ENSURE UNIT ON A FIRM FOUNDATION AND THAT COUPLING FACES ARE IN CORRECT ALIGNMENT PRIOR TO AND AFTER BOLTING BASEPLATE DOWN AND FIXING PIPEWORK. SEE MANUAL FOR TOLERANCES.

S'ASSURER QUE LE GROUPE ELECTROPOMPE EST FERMEEMENT INSTALLE SUR SON MASSIF. VERIFIER LE LIGNAGE DE L'ACCOUPLLEMENT AVANT ET APRES FIXATION DU SOCLE ET DE LA TUYAUTERIE. VOIR LES TOLERANCES D'ALIGNEMENT SUR LA NOTICE

PUMP MUSS AUF FESTEM FUNDAMENT STEHEN. KUPPLUNGSHÄLFTEN KORREKT AXIAL AUSRICHTEN. DANN PUMPE AUF GRUNDPLATTE FESTSPANNEN UND ANSCHLUSSLEITUNGEN BEFESTIGEN. TOLERANZEN S. BEDIEUNGSANLEITUNG.

ZORG DAT POMPEENHEID OP EEN STEVIGE ONDERGROND OPGESTELD STAAT EN DAT KOPPELING CORRECT UITGELIJNT IS ZOWEL VOOR-ALS NADAT DE GRONDPLAAT MET BOUTEN IS VASTGEZET EN DE LEIDINGEN GEINSTALLEERD ZIJN. ZIE HANDLEIDING VOOR TOELAABARE SPELINGEN.

to control the exposure time to the noise or to enclose the machine to reduce emitted sound.

You may have already specified a limiting noise level when the equipment was ordered, however if no noise requirements were defined, then attention is drawn to the following table to give an indication of equipment noise level so that you can take the appropriate action in your plant.

Pump noise level is dependent on a number of operational factors, flow rate, pipework design and acoustic characteristics of the building, and so the values given are subject to a 3 dBA tolerance and cannot be guaranteed.

Similarly the motor noise provided in the table below is “pump and motor” noise that is typically expected from standard and high efficiency motors when on load directly driving the pump. Note that a motor driven by an inverter may show an increased noise at some speeds.

If a pump unit only has been purchased for fitting with your own driver, then the noise levels in the table should be adjusted for the driver level obtained from the supplier. Consult Flowserve or a noise specialist if assistance is required in adjusting the values.

It is recommended that where exposure approaches the prescribed limit, then site noise measurements should be made. The values are in sound pressure level  $L_{pA}$  at 1 m (3.3 ft) from the machine, for “free field conditions over a reflecting plane”.

Typical sound pressure level (Pump and Motor) LpA at 1 m (3.3 ft.) reference 20 µPa, dBA				
Pump Series	3550 rpm	2900 rpm	1750 rpm	1450 rpm
U-MAG™	75	69	65	60

**Notes:** (1.) values are for the maximum usable motor size (2.) for 1180 and 960 rpm reduce 1450 rpm values by 2 dBA. For 880 and 720 rpm reduce 1450 rpm values by 3 dBA. (3.) Choosing a fan-cooled motor will increase noise levels. (4.) Placing valves, orifices, or flow meters near a pump will increase noise levels inside the pump.

For estimating sound power level  $L_{WA}$  (re 1 pW) then add 14 dBA to the sound pressure value.

## 2 TRANSPORT AND STORAGE

### 2.1 Consignment receipt and unpacking

Immediately after receipt of the equipment it must be checked against the delivery/shipping documents for

## 1.8 Specific machine performance

For performance parameters see section 1.5, *Duty conditions*. Where performance data has been supplied separately to the purchaser these should be obtained and retained with these User Instructions.

## 1.9 Noise level

Attention must be given to the exposure of personnel to the noise, and local legislation will define when guidance to personnel on noise limitation is required, and when noise exposure reduction is mandatory. This is typically 80 to 85 dBA. The usual approach is

its completeness and that there has been no damage in transportation. Any shortage and/or damage must be reported immediately to Flowserve and must be received in writing within one month of receipt of the equipment. Later claims cannot be accepted.

Check any crate, boxes or wrappings for any accessories or spare parts that may be packed separately with the equipment or attached to side walls of the box or equipment.

Each pump/wet end has a unique serial number. Check that this number corresponds with that advised. Always use this number in correspondence and when ordering spare parts or further accessories.

## 2.2 Handling

Boxes, crates, pallets or cartons may be unloaded using fork lift vehicles or slings dependent on their size and construction.

## 2.3 Lifting

A crane must be used for all pump sets or components in excess of 25 kg (55 lb.). Fully trained personnel must carry out lifting, in accordance with local regulations. Slings, ropes and other lifting gear should be positioned where they cannot slip and where a balanced lift is obtained. The angle between sling or ropes used for lifting must not exceed 60°.

**CAUTION** To avoid distortion, the pump unit should be lifted as shown.

**CAUTION** Pumps and motors often have integral lifting lugs or eye bolts. These are intended for use in only lifting the individual piece of equipment.

**CAUTION** Do not use eye bolts or cast-in lifting lugs to lift pump, motor and baseplate assemblies.

**CAUTION** Care must be taken to lift components or assemblies above the center of gravity to prevent the unit from flipping.

### 2.3.1 Lifting Wet-End

The wet end should be lifted by sling around the pump discharge nozzle using a choker hitch pulled tight as shown in Figure 2-1.

Figure 2-1

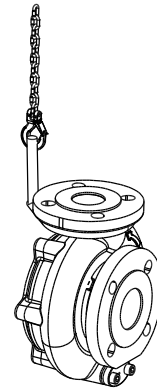

### 2.3.2 Lifting pump and motor assembly

For pump and motor, sling around the pump discharge nozzle, and around the outboard end of the motor frame using choker hitches pulled tight. The sling should be positioned so the weight is not carried through the motor fan housing. (Figure 2-2)

Figure 2-2

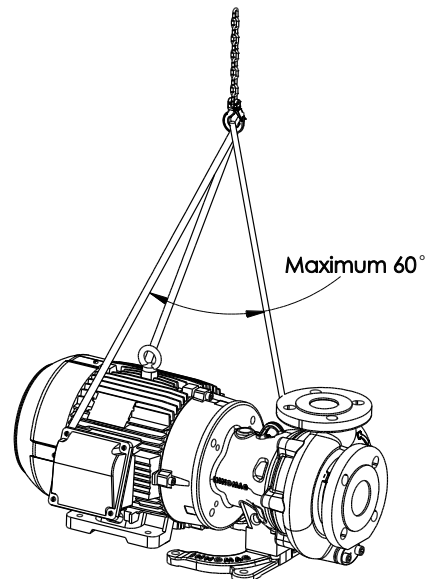

### 2.3.3 Lifting pump, motor and baseplate assembly

If the baseplate has lifting holes cut in the sides at the end (Type D, Type E bases and Type A when provided) insert lifting S hooks at the four corners and use slings or chains to connect to the lifting eye. Do not use slings through the lifting holes.

For other baseplates, sling around the pump discharge nozzle, and around the outboard end of the motor frame using choker hitches pulled tight. The sling should be positioned so the weight is not carried through the motor fan housing. (Figure 2-3)

Figure 2-3

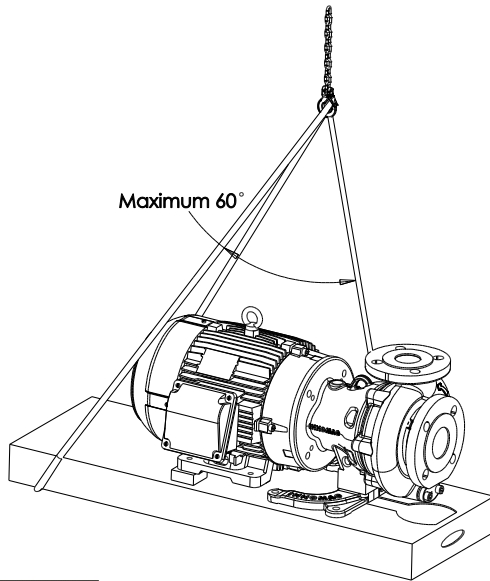

**CAUTION** Assembled units and their components are heavy. Failure to properly lift and support this equipment can result in serious physical injury and/or equipment damage. Lift equipment only at the specifically identified lifting points. Lifting devices such as eyebolts, slings, and spreaders must be rated, selected, and used for the entire load being lifted.

**CAUTION** Crush hazard. The unit and the components can be heavy. Use proper lifting methods and wear steel-toed shoes at all times.

**CAUTION** Do not attach sling ropes to shaft ends.

**CAUTION** Make sure that the unit cannot roll or fall over and injure people or damage property.

These pumps use carbon or ceramic silicon carbide components. Do not drop the pump or subject it to shock loads as this can damage the internal ceramic components.

## 2.4 Storage

**CAUTION** Store the pump in a clean, dry location away from vibration. Leave piping connection covers in place to keep dirt and other foreign material out of pump casing.

The pump may be stored as above for up to 6 months. Consult Flowserve for preservative actions when a longer storage period is needed.

## 2.5 Recycling and end of product life

At the end of the service life of the product or its parts, the relevant materials and parts should be recycled or disposed of using an environmentally acceptable method and local requirements. If the product contains substances that are harmful to the environment, these should be removed and disposed of in accordance with current regulations.

**CAUTION** Make sure that hazardous substances are disposed of safely and that the correct personal protective equipment is used. The safety specifications must be in accordance with the current regulations at all times.

## 3 DESCRIPTION

### 3.1 Configurations

The U-MAG™ chemical process pumps are fluoropolymer lined, magnetically coupled, single stage, centrifugal pumps.

### 3.2 Nomenclature

The pump size will be etched on the nameplate as in this example: U012511100-UB0. See Figure 3-1 for pump identification codes.

### 3.3 Nameplate

Every U-MAG™ pump unit has a nameplate to provide information on your pump. The nameplates are located on the adapter with a second tag containing just the pump serial number affixed to the casing discharge flange. It is recommended that the purchaser record the serial number and use it for reference when requesting information, service, or parts from your supplier.

Permanent records for this pump are kept by the serial number and it, therefore, must be used with all correspondence and spare parts orders. Tag includes the following:

- Pump Model Number: Example – U0
- Pump Code: Example – U013711100-UB0
- Serial Number: Example – 44001
- Impeller Diameter / Max Impeller Diameter (mm or in.)
- Duty Point (Flow/TDH)( m<sup>3</sup>/hr / m or US gpm / ft.)
- Process Liquid Specific Gravity and Temperature (°C or °F)

- Pump RPM / Pump power (kW or hp) @ Duty Point
- Design Pressure (barg or psig) @ 38°C (100 °F)
- Customer Pump Tag #
- Process Liquid Being Pumped

The typical nomenclature above is the general guide to the U-MAG™ configuration description. Identify the actual pump size and serial number from the pump nameplate. Check that this agrees with the applicable certification provided.

Figure 3-1

U-MAG™ PUMP IDENTIFICATION CODE										
Wet End			U0	137	1 1 1 0 0	-	U	B	0	Drive End
<b>Models</b> (Suction x Discharge x Nominal Impeller Diameter)										
<b>Size</b>		<b>Min.</b>	<b>Max.</b>							
U0 - (1.5 x 1 x 5") (40 x 25 x 127mm)		3.25"	6.13"							
UL/UM/UN (1.5 x 1 x 5LF") (40 x 25 x 127mm)		83	156 mm							
U1 - (2 x 1.5 x 6") (50 x 40 x 152mm)		3.25"	6.13"							
U3 - (3 x 2.5 x 6") (80 x 65 x 152mm)		83	156 mm							
U4 - (2.5 x 2 x 6") (65 x 50 x 152mm)		4.50"	6.13"							
		114	156 mm							
		3.50"	6.13"							
		89	156 mm							
<b>Impeller Diameter</b>										
† 137 mm, divide by 25.4 for inches ex. 137/25.4= 5.39 in										
† Impeller trim for U-MAG™ models must be specified in mm.										
<b>Bearing System</b>										
<b>Bushing</b>		<b>Shaft, Pump</b>								
S 0 - Carbon Graphite		SiC								
\$ 1 - SiC		SiC								
C\$ 2 - SiC + DLC		SiC								
C\$ 4 - SiC - Spiral Groove		SiC								
C\$ 6 - SiC - Grooved + DLC		SiC								
<b>Wear Ring/Thrust Collar</b>										
<b>Impeller</b>		<b>Casing</b>		<b>Containment Shell</b>						
S 0 - CF-PTFE		SiC		CF-PTFE						
\$ 1 - SiC		SiC		SiC						
<b>Gasket</b> (All Gaskets are 0.210" square cross section, equivalent to standard -363 O-Rings)										
S 1 - FEP/FKM (Fluorocarbon)										
2 - FKM (Fluorocarbon)										
3 - EPDM (Ethylene Propylene)										
<b>Flanges</b>										
S 0 - ANSI/ISO/JIS (Universally Slotted)										
1 - ANSI (Class 150)										
2 - ISO (PN16)										
3 - JIS (10kg/cm <sup>2</sup> ) - JIS B2210 - 1989										
<b>Construction</b>										
<b>Impeller Body</b>		<b>Casing Casting/Lining</b>	<b>Retaining Rings</b>	<b>Casing Drain</b>	<b>Containment Shell Lining/Composite</b>					
S 0 - CF-ETFE		D.I./ETFE	CF-ETFE	No	CF-ETFE/Aramid					
1 - CF-ETFE		D.I./ETFE	CF-ETFE	Yes	CF-ETFE/Aramid					
C\$\$2 - PFA		D.I./PFA	PFA	No	PFA/Aramid					
<b>Drive Torque Option</b>										
0 - Standard Torque										
1 - High Torque										
<b>Motor Frame</b>										
<b>NEMA C-Face</b>										
A - 56C										
B - 143/5 TC										
C - 182/4 TC										
\$t D - 213/5 TC										
\$t E - 254/6 TC										
\$Gt X - For 1" Shaft										
\$Ht 2 - For 1.25" hydraulic motor										
<b>IEC B5</b>										
M - 80										
N - 90S/L										
P - 100L/112M										
\$t R - 132										
<b>Product Group</b>										
U - U-MAG™										
<b>Notes:</b>										
<b>Material Guide:</b>										
CF - Carbon Fiber										
D.I. - Ductile Iron										
ETFE - Ethylenetetrafluoroethylene										
PTFE - Polytetrafluoroethylene										
PFA - Perfluoroalkoxy										
SiC - Silicon Carbide (Ceramic)										
S Standard Material/Options										
C Consult Factory for Availability										
\$t High Torque Option										
\$ Price Adder										
G Gas Engine Motor										
H Hydraulic Motor (SAE)										

Rev. Date 4/17/2014

Not an exhaustive list. Available options subject to change without notice. Consult factory for availability and pricing.

### 3.4 Design of major parts

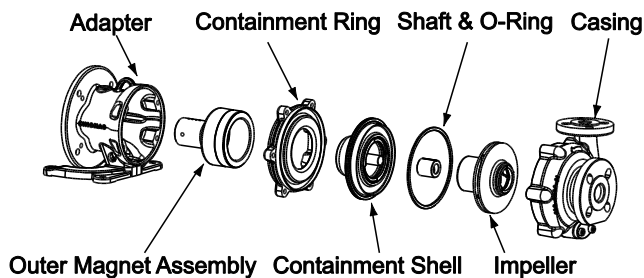

#### 3.4.1 Pump casing

Ductile iron armor with bonded ETFE lining. The U-MAG™ pump casing is designed with a horizontal centerline end inlet and a top outlet.

For ease of maintenance, the pump is constructed so that pipe connectors do not have to be disturbed when internal maintenance is required (back pull out).

#### 3.4.2 Impeller

Integrally molded one-piece impeller / inner rotor. The impeller is fully shrouded (closed) with fully open suction, and the inner rotor is fitted with Neodymium Iron Boron (NdFeB) magnets.

#### 3.4.3 Wetted Bearings System

The standard material for the bearing is carbon and the shaft is alpha sintered silicon carbide (SiC). The system is comprised of a shaft which is cantilever mounted into the containment shell and a rotating bushing mounted in the impeller. The impeller's wear ring is carbon as standard and runs against the casing thrust collar, which is SiC.

#### 3.4.4 Containment Ring

One-piece ductile iron part aligns and supports the containment shell to establish the pressure boundary of the pump. Allows servicing of the motor without opening the liquid end of the pump.

#### 3.4.5 Outer Magnet Assembly

One-piece ductile iron housing fitted with Neodymium Iron Boron (NdFeB) magnets. One common outer rotor for each motor frame and a visual alignment groove allows for ease of axial alignment.

#### 3.4.6 Containment Shell and O-Ring

The containment shell is comprised of an aramid fiber composite outer housing and an ETFE liner. The shell includes a fully confined O-ring groove which establishes the gasket interface with the casing.

#### 3.4.7 Adapter

Mates pump to motor. Design allows the use of multiple motors with one adapter.

#### 3.4.8 Driver

The driver is normally an electric motor. Different drive configurations may be fitted such as internal combustion engines, turbines, hydraulic motors, and driving via couplings, belts, gearboxes, drive shafts, etc.

#### 3.4.9 Accessories

Accessories may be fitted when specified by the customer

### 3.5 Performance and operating limits

This product has been selected to meet the specifications of the purchase order. See section 1.5.

The following data is included as additional information to help with your installation. It is typical, and factors such as temperature and materials may influence this data. If required, a definitive statement for your particular application can be obtained from Flowserve.

#### 3.5.1 Operating limits

Normal maximum ambient temperature:  
+40 °C (104 °F).

Normal minimum ambient temperature:  
-20 °C (-4 °F).

Maximum pump speed: refer to the nameplate.

#### 3.5.2 Pressure-Temperature Rating

The pump pressure and temperature limits are included in the Figure 3-2. The standard U-MAG™ casing has a universal, slotted flange bolt pattern which accommodates ANSI, ISO, and JIS piping flange standards. Optional drilling arrangements include ANSI Class 150, ISO PN 16, and JIS 10K. Find the maximum allowable pressure for the supplied pump, given the flange drilling pattern and operating temperature.



The maximum discharge pressure must be less than or equal to the P-T rating. Discharge pressure may be approximated by adding the suction pressure to the differential pressure developed by the pump.



Figure 3-2

	Temperature - °C (°F)				
	-29 (-20)	-18 (0)	38 (100)	93 (200)	121 (250)
	Pressure - barg (psig)				
ANSI, ISO, JIS Slotted	14 (203)	14 (203)	14 (203)	14 (203)	14 (203)
ASME B16.42 Class 150	17.2 (250)	17.2 (250)	17.2 (250)	16.2 (235)	15.5 (225)
EN 1092-2 (ISO) PN 16	16 (232)	16 (232)	16 (232)	16 (232)	16 (232)
JIS B2239 10K	14 (203)	14 (203)	14 (203)	14 (203)	14 (203)

### 3.5.3 Energy Efficiency Operation of Pumps

The pump supplied will have been selected from Flowserve's extensive product line to have optimum efficiency for the application. If supplied with an electric motor then the motor will meet or exceed current legislation for motor efficiency. However it is the way the pump is operated which has the greatest impact on the amount and cost of energy used during the operating life of the pump. The following are key points in achieving minimum operating cost for the equipment:

- a) Design the pipe system for minimum friction losses
- b) Ensure that the control system switches off the pump when not required
- c) In a multi-pump system run the minimum number of pumps
- d) Try to avoid systems which by-pass excess flow
- e) Avoid as far as possible controlling pump flow by throttle valves
- f) When commissioned, check that the pump operates at the duty specified to Flowserve
- g) If it has been found that the pump head and flow exceed that required, trim the pump impeller diameter
- h) Ensure that the pump is operating with sufficient NPSH available.
- i) Use variable speed drives for systems which require variable flow. A VFD for an induction motor is a particularly effective way of achieving speed variation and energy/cost reduction
- j) Notes for VFD usage

- a) make sure that the motor is compatible with VFD
- b) Do not over-speed the pump without checking the power capability with Flowserve
- c) On systems with high static head, speed reduction is limited. Avoid running the pump at a speed which gives low or zero flow
- d) Do not run at a low speed and flow rate which lets solid settle out of suspension in the pipe work
- e) Do not use a VFD for a fixed flow requirement; it will introduce power losses

- k) Select high efficiency motors
- l) If replacing a standard motor with a high efficiency motor it will run faster and the pump could take more power. Reduce the impeller diameter to achieve energy reduction
- m) If the pump system pipe work or equipment is changed or process duty is changed, check that the pump is still correctly sized
- n) Periodically check that the pipe system has not become corroded or blocked
- o) Periodically check that the pump is operating at the flow, head and power expected and that the efficiency has not reduced with erosion or corrosion damage.

## 4 INSTALLATION



Equipment operated in hazardous locations must comply with the relevant explosion protection regulations. See section 1.6.4, *Products used in potentially explosive atmospheres*.

### 4.1 Location

The pump should be located to allow room for access, ventilation, maintenance and inspection with ample headroom for lifting and should be as close as practicable to the supply of liquid to be pumped. Refer to the general arrangement drawing for the pump set.

### 4.2 Part Assemblies

The supply of motors and baseplates are optional. As a result, it is the responsibility of the installer to ensure that the motor is assembled to the pump and aligned as detailed in section 4.5 and 4.8.

### 4.3 Foundation



A pump should be located near the supply of liquid and have adequate space for operation, maintenance, and inspection. Baseplate mounted pumps are normally placed on a concrete foundation, which has been poured on a solid footing. The foundation must be able to absorb any vibration and to form a permanent, rigid support for the pumping unit.

- a) Prepare site - Inspect foundation for dirt, oil, chips, water, etc. and remove any contaminants.
- b) Install mounting bolts using hole pattern determined by baseplate size. Sleeve-type and J-type bolts are commonly used to allow movement for final bolt adjustment. Follow best company standards and practices.

#### 4.3.1 Protection of openings and threads

When the pump is shipped, all openings are covered. This protection/covering should not be removed until installation. If, for any reason, the pump is removed from service, this protection should be reinstalled.

#### 4.3.2 Rigid baseplates - overview

The function of a baseplate is to provide a rigid foundation under a pump and its driver that maintains alignment between the two. Baseplates may be generally classified into two types:

- Foundation-mounted, grouted design (Figure 4-1)
- Stilt mounted, or free standing. (Figure 4-2.)

Figure 4-1



Figure 4-2



Baseplates intended for grouted installation are designed to use the grout as a stiffening member.

Stilt mounted baseplates, on the other hand, are designed to provide their own rigidity. Therefore the designs of the two baseplates are usually different.

Regardless of the type of baseplate used, it must provide certain functions that ensure a reliable installation. Three of these requirements are:

- The baseplate must provide sufficient rigidity to assure the assembly can be transported and installed, given reasonable care in handling, without damage. It must also be rigid enough when properly installed to resist operating loads.
- The baseplate must provide a reasonably flat mounting surface for the pump and driver. Uneven surfaces will result in a soft-foot condition. Experience indicates that a baseplate with a top surface flatness of 1.25 mm/m (0.015 in./ft) across the diagonal corners of the baseplate provides such a mounting surface. Therefore, this is the tolerance to which we supply our standard baseplate. Some users may desire an even flatter surface, which can facilitate installation and alignment. Flowserve will supply flatter baseplates upon request at extra cost. For example, mounting surface flatness of 0.17 mm/m (0.002 in./ft) is offered on the Flowserve Type E “Ten Point” baseplate in Figure 4-1.
- The baseplate must be designed to allow the user to final field align the pump and driver to within their own particular standards and to compensate for any pump or driver movement that occurred during handling. U-MAG™ pumps have a close-coupled configuration only and alignment is achieved by the mating of precision-machined surfaces. See section 4.8 for more information.

#### 4.3.3 Stilt and spring mounted baseplates

Flowserve offers stilt and spring mounted baseplates. (See Figure 4-2 for stilt mounted option.) The low vibration levels of U-MAG™ pumps allow the use of these baseplates - provided they are of a rigid design. The baseplate is set on a flat surface with no tie down bolts or other means of anchoring it to the floor.

General instructions for assembling these baseplates are given below. For dimensional information, please refer to the appropriate Flowserve “Sales print.”

##### 4.3.3.1 Stilt mounted baseplate assembly instructions

Refer to Figure 4-3.

- a) Raise or block up baseplate/pump above the floor to allow for the assembly of the stilts.
- b) Predetermine or measure the approximate desired height for the baseplate above the floor.
- c) Set the bottom nuts [2] above the stilt bolt head [1] to the desired height.
- d) Assemble lock washer [3] down over the stilt bolt.

- e) Assemble the stilt bolt up through hole in the bottom plate and hold in place.
- f) Assemble the lock washer [3] and nut [2] on the stilt bolt. Tighten the nut down on the lock washer.
- g) After all four stilts have been assembled, position the baseplate in place, over the floor cups [4] under each stilt location, and lower the baseplate to the floor.
- h) Level and make final height adjustments to the suction and discharge pipe by first loosening the top nuts and turning the bottom nuts to raise or lower the baseplate.
- i) Tighten the top and bottom nuts at the lock washer [3] first then tighten the other nuts.
- j) It should be noted that the connecting pipelines must be individually supported, and that the stilt mounted baseplate is not intended to support total static pipe load.

Figure 4-3

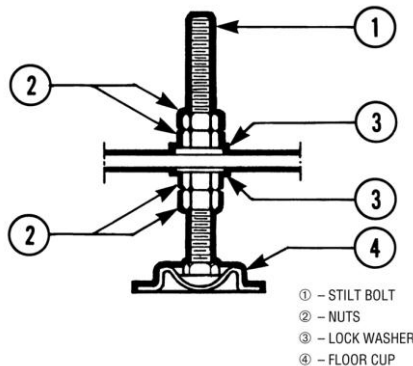

**4.3.3.2 Stilt/spring mounted baseplate assembly instructions**

Refer to Figure 4-4.

- a) Raise or block up baseplate/pump above the floor to allow for the assembly of the stilts.
- b) Set the bottom nuts [4] above the stilt bolt head [1]. This allows for 51 mm (2 in.) upward movement for the final height adjustment of the suction/discharge flange.
- c) Assemble the lock washer [6] flat washer [5] and bottom spring/cup assembly [2] down over the stilt bolt [1].
- d) Assemble the stilt bolt/bottom spring up through hole in the bottom plate and hold in place.
- e) Assemble top spring/cup assembly [3] down over stilt bolt.
- f) Assemble flat washer [5], lock washer [6] and nuts [4] on the stilt bolt.
- g) Tighten down top nuts, compressing the top spring approximately 13 mm (0.5 in.). Additional compression may be required to stabilize the baseplate.

- h) After all four stilts have been assembled, position the baseplate in place, over the floor cups [7] under each stilt location, and lower the baseplate down to the floor.
- i) Level and make final height adjustments to the suction and discharge pipe by first loosening the top nuts, and turning the bottom nuts to raise or lower the baseplate.
- j) Recompress the top spring to the compression established in step g, and lock the nuts in place.
- k) It should be noted that the connecting pipelines must be individually supported, and that the spring mounted baseplate is not intended to support total static pipe loads.

Figure 4-4

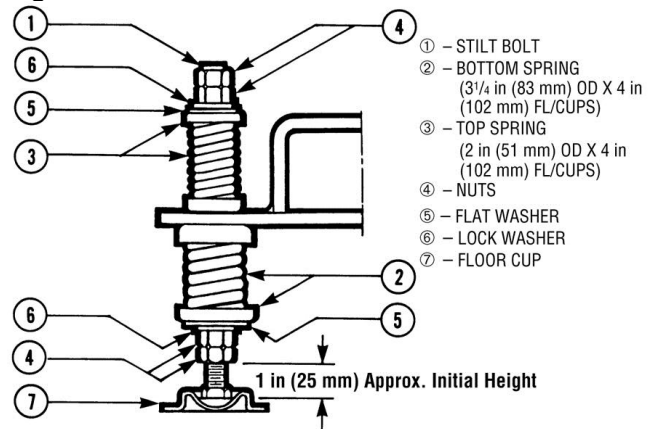

The remaining steps are as listed for new grouted baseplates.

**4.4 Grouting**

Where applicable, grout in the foundation bolts. Foundation bolts should only be fully tightened when the grout has cured.

After adding pipework connections and rechecking the pump alignment, the baseplate should then be grouted in accordance with good engineering practice. Fabricated steel, folded steel and cast iron baseplates can be filled with grout. Polycrte baseplates cannot be grouted in the same way, see their User Instructions 71569284 (E) for installation and use. If in any doubt, please contact your nearest service center for advice.

Grouting provides solid contact between the pump unit and foundation prevents lateral movement of vibrating equipment and dampens resonant vibrations.

**4.4.1 Baseplate Inspection**

- a) Completely clean the underside of baseplate.

- b) Inspect for any damage that would impede proper installation or future use of the baseplate.
- c) Confirm baseplate hole pattern for proper mounting bolt installation.
- d) Lower the baseplate carefully onto mounting bolts. Caution: Must adhere to proper transport and lifting procedures.
- e) Level the baseplate using shims and/or wedges. Use machinist's levels to maintain a flat and level surface.

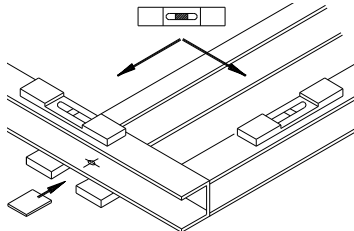

- f) Max difference across length 3.2 mm (0.125 in.)
- g) Max difference across width 1.5 mm (0.059 in.)
- h) Secure baseplate using mounting bolts to prevent unwanted movement during operation. Torque bolts to appropriate company standards and practices.
- i) Perform final inspection to verify that baseplate is securely mounted, level, and ready to be used.

## 4.5 Piping



Protective covers are fitted to both the suction and discharge flanges of the casing and must be removed prior to connecting the pump to any pipes.

### 4.5.1 Suction and discharge piping



Never use pump as a support for piping.



Ensure piping and fittings are flushed before use.



Ensure piping for hazardous liquids is arranged to allow pump flushing before removal of the pump.

Take into account the available NPSH which must be higher than the required NPSH of the pump.

All piping must be independently supported, accurately aligned and preferably connected to the pump by a short length of flexible piping. The pump should not have to support the weight of the pipe or compensate for misalignment. It should be possible to install suction and discharge bolts through mating flanges without pulling or prying either of the flanges. All piping must be

tight. Pumps may air-bind if air is allowed to leak into the piping. If the pump flange(s) have tapped holes, select flange fasteners with thread engagement at least equal to the fastener diameter but that do not bottom out in the tapped holes before the joint is tight.

The following is the recommended procedure for attaching piping to the U-MAG™ pump (see section 6.5 for torque values)

- Check the surface of both flanges (pump/pipe) to ensure they are clean, flat, and without defects
- Lubricate the fasteners
- Hand tighten all of the fasteners in a crisscross pattern
- The fasteners should be torqued in increments – based a crisscross pattern
- See torque chart in Section 6.5
  - The first increment should be 75% of full torque
  - The second increment should be at the full torque
  - Verify that the torque value of the 1<sup>st</sup> fastener is still at the full torque value. Re-torque all fasteners after 24 hours or after the first thermal cycle.
- Re-torque all fasteners at least annually

### 4.5.2 Suction piping

To avoid NPSH and suction problems, suction piping must be at least as large as the pump suction connection. Never use pipe or fittings on the suction that are smaller in diameter than the pump suction size.

Figure 4-5 illustrates the ideal piping configuration with a minimum of 10 pipe diameters between the source and the pump suction. In most cases, horizontal reducers should be eccentric and mounted with the flat side up as shown in Figure 4-6 with a maximum of one pipe size reduction. Never mount eccentric reducers with the flat side down. Horizontally mounted concentric reducers should not be used if there is any possibility of entrained air in the process fluid. Vertically mounted concentric reducers are acceptable. In applications where the fluid is completely de-aerated and free of any vapour or suspended solids, concentric reducers are preferable to eccentric reducers.

Figure 4-5

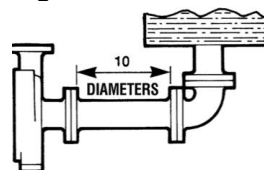
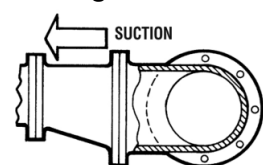

Figure 4-6





Avoid the use of throttling valves and strainers in the suction line. Start-up strainers must be removed shortly before start up. When the pump is installed below the source of supply, a valve should be installed in the suction line to isolate the pump and permit pump inspection and maintenance. However, never place a valve directly on the suction nozzle of the pump.

Refer to the Centrifugal Pump IOM Section of the H.I. Standards for additional recommendations on suction piping. (See section 10.)

Refer to section 3.4 for performance and operating limits.

#### 4.5.3 Discharge piping

Install a valve in the discharge line. This valve is required for regulating flow and/or to isolate the pump for inspection and maintenance.

 When fluid velocity in the pipe is high, for example, 3 m/s (10 ft/sec) or higher, a rapidly closing discharge valve can cause a damaging pressure surge. A dampening arrangement should be provided in the piping.

#### 4.5.4 Allowable nozzle loads

Maximum forces and moments allowed on the pump flanges vary with the pump size and type. To minimize these forces and moments that may, if excessive, cause misalignment, hot bearings, worn couplings, vibration and the possible failure of the pump casing, the following points should be strictly followed:

- Prevent excessive external pipe load
- Never draw piping into place by applying force to pump flange connections
- Do not mount expansion joints so that their force, due to internal pressure, acts on the pump flange

Contact your local Flowserve Sales office, Distributor, or Representative for further details.

#### 4.5.5 Auxiliary piping

 The connections that are to be piped up will have been fitted with protective metal or plastic plugs which will need to be removed.

#### 4.6 Electrical connections

 **DANGER** Electrical connections must be made by a qualified Electrician in accordance with relevant local national and international regulations.

 It is important to be aware of the EUROPEAN DIRECTIVE on potentially explosive areas where compliance with IEC60079-14 is an additional requirement for making electrical connections.

 It is important to be aware of the EUROPEAN DIRECTIVE on electromagnetic compatibility when wiring up and installing equipment on site. Attention must be paid to ensure that the techniques used during wiring/installation do not increase electromagnetic emissions or decrease the electromagnetic immunity of the equipment, wiring or any connected devices. If you have any doubt contact Flowserve for advice.

 **DANGER** The motor must be wired up in accordance with the motor manufacturer's instructions (normally supplied within the terminal box) including any temperature, earth leakage, current and other protective devices as appropriate. The identification nameplate should be checked to ensure the power supply is appropriate.

 A device to provide emergency stopping must be fitted. If not supplied pre-wired to the pump unit, the controller/starter electrical details will also be supplied within the controller/starter. For electrical details on pump sets with controllers see the separate wiring diagram.

 See section 5.1, *Direction of rotation* before connecting the motor to the electrical supply.

 For close coupled pumps it is necessary to wire the motor with flexible conduit of sufficient length to allow the motor/power end assembly to be moved back from the casing [1100] for maintenance.

#### 4.7 Protection systems

 The following protection systems are recommended particularly if the pump is installed in a potentially explosive area or is handling a hazardous liquid. If in any doubt consult Flowserve.

If there is any possibility of the system allowing the pump to run against a closed valve or below minimum continuous safe flow a protection device should be installed to ensure the temperature of the liquid does not rise to an unsafe level.



If there are any circumstances in which the system can allow the pump to run dry, or start up empty, a power monitor should be fitted to stop the pump or prevent it from being started. This is particularly relevant if the pump is handling a flammable liquid.

If leakage of product from the pump or its associated sealing system can cause a hazard it is recommended that an appropriate leakage detection system is installed.

To prevent excessive surface temperatures at bearings it is recommended that temperature or vibration monitoring is carried out.

#### 4.7.1 Auxiliary equipment – instrumentation

Contact your local Flowserve Sales office, Distributor, or Representative for more details.

##### 4.7.1.1 Leak detection

An intrinsically-safe, optical leak detection system is available for U-MAG™ pumps.

##### 4.7.1.2 Temperature probe

An optional ThermicSense temperature probe can be installed on the casing drain to monitor the internal fluid in the casing [1100].

##### 4.7.1.3 ThermicSense Installation

The ThermicSense thermowell will be packaged separately for protection during shipping and must be assembled before use. For wiring refer to the thermocouple sensor manufacturer's instructions

- a) Verify that rubber gasket / o-ring is secured to temperature sensor tip.
- b) Insert temperature sensor tip into the thermowell and hand tighten.
- c) Use a 1/2 in. wrench to fully secure the sensor to the thermowell.

 **CAUTION** Do not over-tighten.

- d) Adjust direction of sensor sheathing before tightening compression fitting.
- e) Ensure sensor tip is fully pressed into thermowell.

**Note:** The sensor must be fully inserted to get an accurate reading.

- f) Hand-tighten the compression fitting.
- g) Use a 1/2 in. wrench to fully tighten the compression fitting and secure sensor sheathing.

 **CAUTION** Do not over tighten the fitting.

- h) Affix the PTFE drain gasket to thermal well.

- i) Insert the completed ThermicSense assembly into the casing drain and insert 1/2 in.-13 bolts with lock washers.
- j) Tighten bolts evenly to maintain alignment and torque to 13.5 Nm (10 lbf•ft)
- k) Install wire leads to appropriate temperature monitor per manufacturer instructions and guidelines.

## 4.8 Final checks

Alignment between the pump shaft and motor shaft is built in by precise machining of the parts that position these shafts. Parallel alignment of 0.18 mm (0.007 in.) and angular alignment of 0.002 mm/mm (0.002 in./in.) can be expected.

Check the tightness of all bolts in the suction and discharge pipework. Check also the tightness of all foundation bolts.

## 5 COMMISSIONING, START-UP, OPERATION AND SHUTDOWN

 **CAUTION** *These operations must be carried out by fully trained and qualified personnel.*

 Personal Protection Equipment suitable for the conditions and environment must be worn at all times.

### 5.1 Direction of rotation

 **CAUTION** Correct rotation is indicated by the arrow on the casing [1100]. Improper rotation will not damage the pump however, performance is greatly reduced. Rotation may be determined by viewing the motor's fan.

 **CAUTION** Do not bump the motor to test rotation or run the pump without the suction completely flooded. Dry running can damage the pump in a matter of seconds if the pump is not equipped with dry-run bearings.

 **CAUTION** If maintenance work has been carried out to the site's electricity supply, the direction of rotation should be re-checked in case the supply phasing has been altered.

## 5.2 Priming and auxiliary supplies

### 5.2.1 Auxiliary supplies

**CAUTION** Ensure all electrical, hydraulic, pneumatic, sealant and lubrication systems (as applicable) are connected and operational.

### 5.2.2 Filling and priming

**CAUTION** Ensure inlet pipe and pump casing [1100] is completely full of liquid before starting continuous duty operation.

Priming may be carried out with an ejector, vacuum pump, interceptor or other equipment, or by flooding from the inlet source.

When in service, pumps using inlet pipes with foot valves may be primed by passing liquid back from the outlet pipe through the pump.

## 5.3 Starting the pump

- a) **CAUTION** CLOSE the discharge valve. Fully open the suction valve. Pump requires a flooded suction.
- b) Do not operate pump with suction valve closed. Operating pump more than a few minutes after suction valve closed may cause bearing failure.
- c) Fully open discharge valve to complete priming. Turn back the discharge valve until it is 1/4 to 1/2 open.
- d) Continuous operation against a closed discharge valve may cause pump to overheat.
- e) Start motor and check the outlet pressure.
- f) If the pressure is satisfactory, SLOWLY open the outlet valve.
- g) **CAUTION** Do not run the pump with the outlet valve closed for a period longer than 10 seconds.
- h) If NO pressure, or LOW pressure, STOP the pump. Refer to section 7, *Troubleshooting*, for fault diagnosis.

## 5.4 Running the pump

Care must be taken when operating pump. Safety gloves are essential. Loose clothing must not be worn.

### 5.4.1 Normal vibration levels, alarm and trip

For guidance, pumps generally fall under a classification for rigid support machines within the International rotating machinery standards and the recommended maximum levels are based on those standards.

**CAUTION** Alarm and trip values for installed pumps should be based on the actual measurements taken on the pump in the fully commissioned as new condition. Measuring vibration at regular intervals will then show any deterioration in pump or system operating conditions.

Vibration velocity – unfiltered	Horizontal pumps ≤ 15 kW	Horizontal pumps > 15 kW
	mm/s (in./sec) r.m.s.	
Normal <b>N</b>	≤ 3.0 (0.12)	≤ 4.5 (0.18)
Alarm <b>N x 1.25</b>	≤ 3.8 (0.15)	≤ 5.6 (0.22)
Shutdown trip <b>N x 2.0</b>	≤ 6.0 (0.24)	≤ 9.0 (0.35)

Where a unit is utilized in a vertical shaft configuration with a duck-foot bend onto the pump suction, the following apply:

Vibration velocity – unfiltered	Vertical configurations mm/s (in./sec) r.m.s.
Normal <b>N</b>	≤ 7.1 (0.28)
Alarm <b>N x 1.25</b>	≤ 9.0 (0.35)
Shutdown trip <b>N x 2.0</b>	≤ 14.2 (0.56)

### 5.4.2 Stop/start frequency

Pump sets are normally suitable for the number of equally spaced stop/starts per hour shown in the table below. Check capability of the driver and control/starting system before commissioning.

Motor rating kW (hp)	Maximum stop/starts per hour
Up to 15 (20)	15
Between 15 (20) and 90 (120)	10
Above 90 (120)	6

Where duty and standby pumps are installed it is recommended that they are run alternately every week.

## 5.5 Stopping and shutdown

- a) **CAUTION** Close the discharge valve, but ensure that the pump runs in this condition for no more than a few seconds.
- b) Stop the pump.
- c) **CAUTION** For prolonged shut-downs and especially when ambient temperatures are likely to drop below freezing point, the pump must be drained or otherwise protected.

## 5.6 Hydraulic, mechanical and electrical duty

This product has been supplied to meet the performance specifications of your purchase order, however it is understood that during the life of the product these may change. The following notes may help the user decide how to evaluate the implications of any change. If in doubt contact your nearest Flowserve office.

### 5.6.1 Specific gravity (SG)

Pump capacity and total head in metres (feet) do not change with SG, however pressure displayed on a pressure gauge is directly proportional to SG. Power absorbed is also directly proportional to SG. It is therefore important to check that any change in SG will not overload the pump driver or over-pressurize the pump.

### 5.6.2 Viscosity

For a given flow rate the total head reduces with increased viscosity and increases with reduced viscosity. Also for a given flow rate the power absorbed increases with increased viscosity, and reduces with reduced viscosity. It is important that checks are made with your nearest Flowserve office if changes in viscosity are planned.

### 5.6.3 Pump speed

Changing pump speed effects flow, total head, power consumed, NPSH<sub>R</sub>, noise and vibration. Flow varies in direct proportion to pump speed, head varies as speed ratio squared and power varies as speed ratio cubed. The new duty, however, will also be dependent on the system curve. If increasing the speed, it is important therefore to ensure the maximum pump working pressure is not exceeded, the driver is not overloaded, NPSH<sub>A</sub> > NPSH<sub>R</sub>, and that noise and vibration are within local requirements and regulations.

### 5.6.4 Net positive suction head (NPSH<sub>A</sub>)

NPSH available (NPSH<sub>A</sub>) is a measure of the head available in the pumped liquid, above its vapour pressure, at the pump suction branch.

NPSH required (NPSH<sub>R</sub>) is a measure of the head required in the pumped liquid, above its vapour pressure, to prevent the pump from cavitating. It is important that NPSH<sub>A</sub> > NPSH<sub>R</sub>. The margin between NPSH<sub>A</sub> > NPSH<sub>R</sub> should be as large as possible.

If any change in NPSH<sub>A</sub> is proposed, ensure these margins are not significantly eroded. Refer to the pump performance curve to determine exact requirements particularly if flow has changed.

If in doubt please consult your nearest Flowserve office for advice and details of the minimum allowable margin for your application.

### 5.6.5 Pumped flow

Flow must not fall outside the minimum and maximum continuous safe flow shown on the pump performance curve and or data sheet.

## 6 MAINTENANCE

### 6.1 General



It is the plant operator's responsibility to ensure that all maintenance, inspection and assembly work is carried out by authorized and qualified personnel who have adequately familiarized themselves with the subject matter by studying this manual in detail. (See also section 1.6.2.)



Personal Protection Equipment suitable for the conditions and environment must be worn at all times.

Any work on the machine must be performed when it is at a standstill. It is imperative that the procedure for shutting down the machine is followed

On completion of work all guards and safety devices must be re-installed and made operative again.

Before restarting the machine, the relevant instructions listed in section 5, *Commissioning, start up, operation and shut down* must be observed.

***Oil and grease leaks may make the ground slippery. Machine maintenance must always begin and finish by cleaning the ground and the exterior of the machine.***

If platforms, stairs and guard rails are required for maintenance, they must be placed for easy access to areas where maintenance and inspection are to be carried out. The positioning of these accessories must not limit access or hinder the lifting of the part to be serviced.

When air or compressed inert gas is used in the maintenance process, the operator and anyone in the vicinity must be careful and have the appropriate protection.

Do not spray air or compressed inert gas on skin. Do not direct an air or gas jet towards other people.

Never use air or compressed inert gas to clean clothes.

Before working on the pump, take measures to prevent an uncontrolled start. Put a warning board on the starting device with the words: **"Machine under repair: do not start"**.

With electric drive equipment, lock the main switch open and withdraw any fuses. Put a warning board on the fuse box or main switch with the words: **"Machine under repair: do not connect"**.

Never clean equipment with flammable solvents or carbon tetrachloride. Protect yourself against toxic fumes when using cleaning agents.



When operating with CHARGABLE LIQUIDS with conductivities of <math><10^{-8}</math> S/m, inert gases (e.g. nitrogen) must be used to flush the pump. Before removal of the pump it is recommended to wait one hour to allow static peak charges to be eliminated.



**CAUTION** ALWAYS make certain that no toxic or flammable fumes / vapors remain in the pump casing [1100] or surrounding area.

## 6.2 Maintenance schedule



It is recommended that a maintenance plan and schedule is adopted, in line with these User Instructions, to include the following:

- Any auxiliary systems installed must be monitored, if necessary, to ensure they function correctly.
- Check for any leaks. Pump is designed to be leak-free, any leak is abnormal.
- Check that the duty condition is in the safe operating range for the pump.
- Check vibration, noise level and surface temperature to confirm satisfactory operation.
- Check dirt and dust is removed from areas around close clearances and motors.

Our specialist service personnel can help with preventative maintenance records and provide condition monitoring for temperature and vibration to identify the onset of potential problems.

If any problems are found the following sequence of actions should take place:

- Refer to section 7, *Troubleshooting*, for fault diagnosis.

- Ensure equipment complies with the recommendations in this manual.
- Contact Flowserve if the problem persists.

### 6.2.1 Preventive Maintenance Guidelines

Different applications call for different preventative maintenance schedules. Applications that involve pumping abrasives, or applications that are likely to precipitate solids should be examined on a regular basis to ensure that accumulating solids (if any) are removed. There are many factors that can necessitate periodic preventative maintenance and inspection, but for clean, continuously operating services, preventative maintenance can usually be done without disassembling the pump. See recommended spare parts list for more information.

Devices/techniques to help monitor the pump externally:

- Install pressure gauges on the suction and discharge
- Regularly monitor the process conditions
- Use the motor's fan to check for free rotation
- Use a shaft power monitor to protect the pump as well as monitor pump performance
- Check vibration, noise level and surface temperature to confirm satisfactory operation.

For preventative maintenance schedule recommendations that are specific to your application, please contact your authorized local distributor.

If ABRASIVE SOLIDS are present within the fluid, additional wear of the pump should be expected. Intervals between inspections should be shortened compared to usual times.

### 6.2.2 Routine inspection (daily/weekly)



**CAUTION** The following checks should be made and the appropriate action taken to remedy any deviations:

- Check operating behaviour. Ensure noise, vibration and bearing temperatures are normal.
- Check that there is no abnormal fluid leak from the pump.
- Check any auxiliary equipment or supplies are functioning correctly.



Refer to the manuals of any associated equipment for routine checks needed.

### 6.2.3 Periodic inspection (six monthly)

- a)  Check foundation bolts for security of attachment and corrosion.



Refer to the manuals of any associated equipment for periodic checks needed.

## 6.3 Spare parts

### 6.3.1 Ordering of spares

Flowserve keeps records of all pumps that have been supplied. When ordering spares the following information should be quoted.

- 1) Pump serial number.
- 2) Pump size.
- 3) Part name – taken from section 8.
- 4) Part number – taken from section 8.
- 5) Number of parts required.

The pump size and serial number are shown on the pump nameplate.

To ensure continued satisfactory operation, replacement parts to the original design specification should be obtained from Flowserve. Any change to the original design specification (modification or use of a non-standard part) will invalidate the pump safety certification.

### 6.3.2 Storage of spares

Spares should be stored in a clean dry area away from vibration. Inspection and re-treatment of metallic surfaces (if necessary) with preservative is recommended at 6 monthly intervals.

### 6.3.3 Recommended spares

For two years operation (as per VDMA 24296).

FIN no.	Designation	Number of same size pumps (including stand-by)						
		2	3	4	5	6/7	8/9	10(+)
2200	Impeller Assembly	1			2		20%	
3500	Containment Shell Assembly	1			2		20%	
3041.2, 1500.1, 6810.1	Suction Ring Kit	1			2		20%	
4610	Gasket / O-ring	1	2		3		30%	
0230	Outer Magnet Assembly	-	-	-	1		2	
-	Power end	-	-	-	-	-	1	2

## 6.4 Tools required

A typical range of tools that will be required to maintain these pumps is listed below.

### 6.4.1 Readily available in standard tool kits, and dependent on pump size:

- 8, 10 mm hex key across flats
- 5/16, 3/8 in. hex key across flats
- 15, 19 mm spanner and socket
- 9/16, 3/4 in. wrench and socket
- 3/16 in. T-Handle Allen Wrench
- 5 mm T-Handle Allen Wrench
- Wire Cutter
- Soldering Iron
- Range of screwdrivers
- Soft mallet
- Jackscrew Bolts
  - a) ASME outer magnet [0230]: 1/2 in. - 13 x 4 1/2 in.
  - b) IEC outer magnet [0230]: (2) M8 -1.25 x 30 mm, M12 - 1.75 x 100+mm jackscrew and jackscrew plate (TLG-2042-SI)
- Needle Nose Pliers
- Arbor Press
- Lathe
- Caliper
- Hobby Knife
- Torque Wrench

### 6.4.2 Flowserve INNOMAG® specialized equipment:

- Bushing Installation / Removal Tool:
  - a) 19mm (3/4 in.) Schedule 40 PVC pipe, 100mm (4 in.) long
- Impeller Trimming Sleeve
  - a) Part # TLG-2033-AA

## 6.5 Fastener torques

Fastener	Screw size	Torque Nm (lbf·ft)
All except where otherwise stated	M8 (5/16in.)	16 (12)
	M10 (3/8in.)	25 (18)
	M12 (1/2in.)	35 (26)
	M16 (5/8in.)	80 (59)
	M20 (3/4in.)	130 (96)



Non-metallic gaskets incur creep relaxation - before commissioning the pump check and retighten fasteners to tightening torques stated.



## 6.6 Disassembly

The preventative maintenance and disassembly procedures are intended for use during standard field inspection or service. The disassembly can take place while the pump is piped up or in a maintenance shop. If at all possible, it is recommended to perform all repairs using the shop procedures to reduce the risk of damage to the SiC parts.

Lock out driver power to prevent accidental start-up that could result in serious personal injury. Lock out and/or disconnect power.

**CAUTION** Shut off all valves controlling flow to and from the pump. Isolate the pump from the system and relieve any remaining system pressure.

Refer to *Safety* section before dismantling the pump.

**CAUTION** Before dismantling the pump for overhaul, ensure genuine Flowserve INNOMAG® replacement parts are available.

Refer to sectional drawings for part numbers and identification. (See section 8, *Parts lists and drawings*.)

When operating with chargeable liquids with conductivities of <math><10^{-8}</math> S/m, inert gases (e.g. nitrogen) must be used to flush the pump. Before removal of the pump it is recommended to wait one hour to allow static peak charges to be eliminated.

**CAUTION** When handling hazardous and/or toxic fluids, skin, eye and respiratory protection are required. If pump is being drained, precautions must be taken to prevent injury or environmental contamination.

### 6.6.1 Drive / Wet End Separation

**CAUTION** Flowserve INNOMAG® pumps contain extremely strong magnets. The use of non-magnetic tools and work surface is highly recommended. The work area must be clean and free of any ferrous particles.

**CAUTION** Wet end and drive end separation requires significant care. The magnetic coupling between the impeller [2200] and outer drive [0230] magnets is very strong. This process requires the magnetic field between the outer drive and impeller to be broken.

Figure 6-1

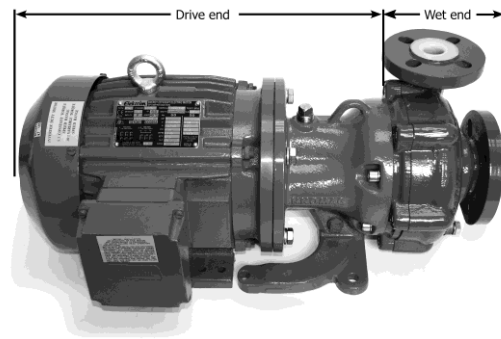

- a) Remove the bolt(s) connecting the support foot [3134] to the base and any bolts connecting the motor to the base.
- b) Remove the four adapter socket head cap screws [6570.1] with an 8mm (5/16 in.) hex key.

**CAUTION** Removing the close-coupled motor requires significant care. The magnetic coupling between the impeller and outer drive magnets is very strong. The next step requires the magnetic field to be broken. It is recommended to have a second person with non-metallic spacers to place between the adapter [1340] and containment ring [3830] to assist in disassembly.

- c) Firmly hold the drive end (which includes the adapter [1340], outer magnet assembly [0230] and the motor) and with smooth, continuous force, pull it away from the wet end. Pull the drive end back at least 150 mm (6 in).

Figure 6-2

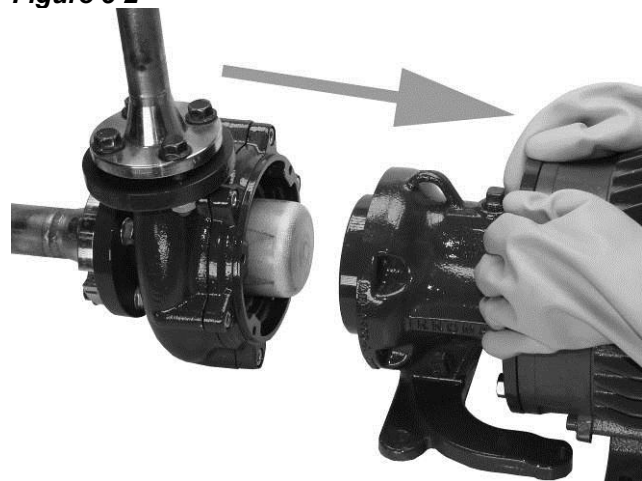

- d) Turn the drive end to the side to allow space for disassembly of the wet end.

### 6.6.2 Wet End Disassembly

Skin, eye and respiratory protection are required when handling hazardous and/or toxic fluids. When draining, precautions must be taken to prevent injury or environmental contamination.

**CAUTION** Ensure suction and discharge valves are completely closed.

Drain the pump and individually decontaminate each component in accordance to all federal, state, local and company environmental regulations.

**CAUTION** Flowserve INNOMAG® pumps contain extremely strong magnets. The use of non-magnetic tools and work surface is highly recommended. The work area must be clean and free of any ferrous particles.

The following procedures assume the drive end and wet end are separated. Refer to section 6.6.1 Drive / Wet End Separation if the motor and pump are connected.

#### 6.6.2.1 Wet End Disassembly – Piped Up

- Remove the drain bolts [6570.1] (if the pump has a drain). Drain the pump and individually decontaminate each component in accordance to all federal, state, local and company environmental regulations.
- Loosen and remove (6) socket head cap screws [6570.1] with an 8 mm (5/16 in.) hex key.
- Grasp the containment shell [3500] and pull the assembly (including impeller [2200], containment shell [3500], and containment ring [3830]) back in a straight line until it is clear of the casing [1100].

Figure 6-3



- Remove the containment shell [3500] and impeller [2200] from the containment ring [3800].  
NOTE: This step is optional as removal of the containment ring may be very difficult on pumps that have been in service for long periods of time.

- Lift and remove the impeller [2200] from the containment shell [3500].

#### 6.6.2.2 Wet End Disassembly – in Shop

- Place a piece of cardboard or a shop towel on the workspace to protect the plastic on the suction flange.
- Lay the wet end face down on the suction flange in the work area.
- Loosen and remove the (6) socket head cap screws [6570.1] on the containment ring [3830] with an 8 mm (5/16 in.) hex key.
- Slightly rotate the containment ring to make it easier to grip.
- Lift the containment ring [3830] with your fingers while holding down the containment shell [3500] with your thumbs.

Figure 6-4



- Lift the containment shell straight [3500] up from the impeller [2200].
- Carefully lift and remove the impeller [2200] from the casing [1100].

## 6.7 Examination of parts

**CAUTION** Used parts must be inspected before assembly to ensure the pump will subsequently run properly. In particular, fault diagnosis is essential to enhance pump and plant reliability.

### 6.7.1 Casing [1100] lining

Inspect the casing [1100] lining for any abrasion, cracks or delamination. Casing [1100] replacement is necessary if lining is breached. Minor scratches or cuts less than 0.1 mm (0.040 in.) depth are acceptable.

### 6.7.2 Silicon Carbide (SiC)

When inspecting the pump internals check all Silicon Carbide (SiC) parts for cracks, chips and scoring marks. Minor chips less than 0.5 mm (0.020 in.) are acceptable. If replacement of any part is required,

follow the procedures in the repair sections of this manual. Carefully clean and inspect all internal parts.

**6.7.3 Containment Shell [3500]**

Use a torch (flashlight) to inspect inside the containment shell [3500], particulate control ring and thrust collar [3041.2].

**6.7.4 Gasket, O-ring [4610]**

After dismantling, discard and replace.

**6.7.5 Impeller [2200]**

The bearing [3300] can be easily replaced if damaged however the wear ring is molded in place and is not user replaceable (see section 6.10). If wear ring is damaged, the impeller will need to be replaced.

**6.7.6 Outer Magnet [0230]**

Wipe the inside of the outer magnet assembly [0230] clean from all foreign particles.

**6.8 Casing [1100] Repair**

**6.8.1 Casing Thrust Collar [3041.2] Removal**

**Note:** Unless there is visual damage to the front thrust collar, removal is not necessary and is not part of the normal inspection procedure.

- a) Insert a flathead screwdriver into the casing notch opposite the weld and force out the retaining ring [6810.1].

**Figure 6-5**



- b) Lift out the thrust collar [3041.2] with your fingers. Pull the retaining ring [6810.1] free and remove the locking pin.

**6.8.2 Casing Thrust Collar [3041.2] Installation**

- a) Insert and align the casing thrust collar (SiC) [3041.2] keyway with the keyway notch in the casing [1100].
- b) Insert the locking pin into one keyway notch.

- c) Insert the keyed end of the retaining ring [6810.1] into the remaining keyway.

**Figure 6-6**



- d) Press the retaining ring [6810.1] into the casing groove.
- e) Trim the retaining ring [6810.1] end so it slightly overlaps the drive pin.

**Figure 6-7**



- f) Line up the tip of a T-handle hex key at the end of the retaining ring [6810.1].
- g) Gently tap the retaining ring [6810.1] into position.

**Figure 6-8**



- h) With a soldering iron, melt the two plastic ends together.



## 6.9 Containment Shell [3500] Repair

**Note:** Unless there is visual damage to the particulate control ring [1500.2], removal is not necessary and is not part of the normal inspection procedure. If the particulate control ring [1500.2] is damaged, it must be replaced.

### 6.9.1 Particulate Control Ring [1500.2] Removal

- a) With small channel lock pliers, grip the old particulate control ring near one of the notches and pull it out.

Figure 6-9

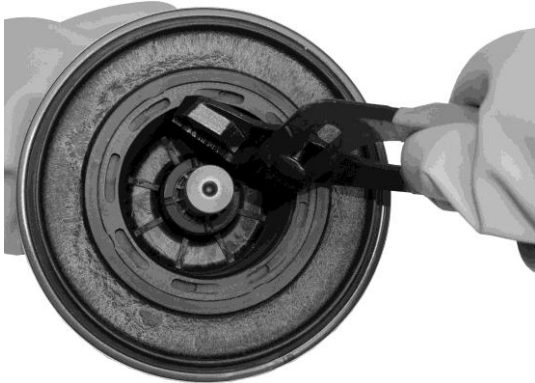

### 6.9.2 Particulate Control Ring [1500.2] Installation

- a) Align the notches on the outer edge of the new particulate control ring with the containment shell's molded keys and press in place.

Figure 6-10

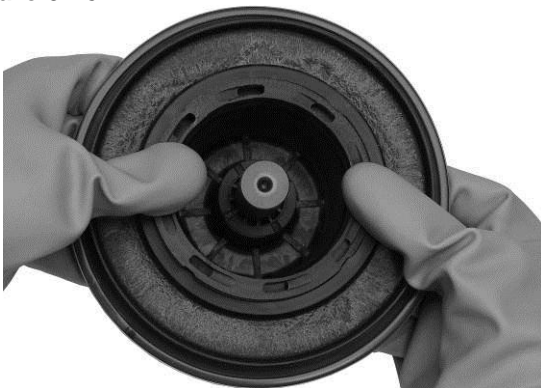

### 6.9.3 O-Ring [4610] Installation

- a) Check the o-ring [4610] for dirt or deformation before placing on the containment shell [3500]. Replace the o-ring if necessary.

- b) Secure the containment shell [3500] composite side down. An empty adapter [1340] works well to hold the containment shell [3500] in place if nothing else is available.
- c) Attach one side of the o-ring [4610] around the containment shell [3500] rim.
- d) Slide your index fingers around the containment shell [3500] on the o-ring's [4610] surface, forcing it down into position while holding it with your thumbs. The o-ring [4610] will snap into place.

Figure 6-11



## 6.10 Impeller Repair

### 6.10.1 Bushing Removal

**Note:** This procedure requires 100 mm (4 in.) length of 3/4 in. Schedule 40 PVC Pipe.

**CAUTION** Make sure the bushing removal tool is perfectly centered to prevent damaging the inside of the impeller [2200]. We recommend placing a shop towel under the impeller [2200] to prevent damage to the SiC bushing [3300] when it falls free.

- a) **CAUTION** Center the impeller on an arbor press, wear ring [3043] side up.
- b) Center the PVC bushing tool on the bushing [3300].
- c) Place something soft such as a shop towel underneath the impeller [2200] to catch the bushing [3300] as it falls.
- d) Carefully press the bushing [3300] down until it dislodges and falls from the impeller [2200].

Figure 6-12

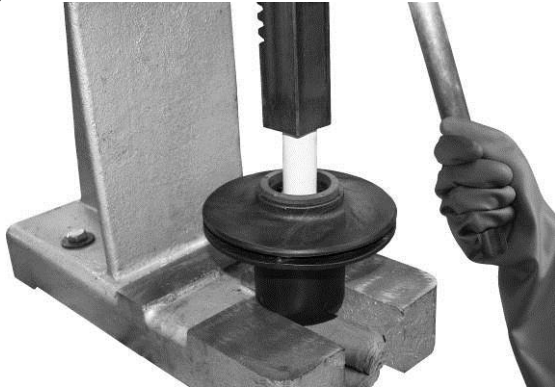

### 6.10.2 Bushing Installation

- a) Line up the bushing's [3300] locking groove with the molded key inside the impeller [2200].

Figure 6-13



- b) Insert the bushing [3300], making sure to maintain alignment while inserting into the arbor press.

**CAUTION** Make sure the bushing removal tool is perfectly centered to prevent damaging the inside of the impeller [2200]. We recommend placing a shop towel under the impeller to prevent damage to the impeller front wear ring [3043].

- c) Center the PVC pipe on the bushing and press the bushing [3300] into place. When properly inserted, the bushing [3300] should be flush with the bottom ledge of the impeller [2200].

### 6.10.3 Front Rotating Wear Ring [3043]

The U-MAG™ impeller wear ring [3043] is not user replaceable. Contact your Flowserve representative for repair or replacement.

### 6.10.4 Impeller Trimming

**CAUTION** Place the trimming sleeve (Part # TLG-2033-FM) over the impeller [2200] to protect it from damage.

Figure 6-14



- a) Using a calipers, measure the current diameter of the impeller [2200].
- b) Insert the impeller [2200] into the lathe and tighten the jaws.
- c) Set the trim 6 mm (1/4 in.) less than the current diameter. If you have never trimmed an impeller [2200] before, then we recommend only cutting 3 mm (1/8 in.) at a time.
- d) Trim the first pass at a slow speed.
- e) Use the hobby knife to clean off the loose plastic on the impeller [2200] in order to get an accurate measurement.

Figure 6-15



- f) Check the diameter again with the caliper.
- g) Set the lathe for 6 mm (1/4 in.) less than the current diameter measurement.
- h) Trim this layer at a slow speed.
- i) Clean off any loose plastic that would interfere with your diameter measurements.
- j) Use the caliper to measure the current diameter.



- k) Repeat the proceeding four steps until you reach the desired diameter.
- l) Chamfer the front and back outer edges of the impeller [2200].
- m) Loosen the jaws and remove the Impeller [2200].
- n) Remove the trimming sleeve and trim any remaining loose plastic with a hobby knife.

## 6.11 Wet End Assembly

### 6.11.1 Piped Up Assembly



Thoroughly clean all parts before assembly. Make sure all parts are free of dirt, metallic particles, etc.



**CAUTION**

With U-MAG™ pumps, we highly recommend following the shop assembly procedure (Section 6.11.2) to minimize the chance of damaging the SiC. Due to the brittle nature of SiC, all assemblies must be handled with care to avoid chipping or cracking.

- a) Align and slide the impeller [2200] onto the pump shaft [2100] located inside the containment shell [3500].
- b) Insert the assembled impeller [2200] and containment shell [3500] into the containment ring [3830]
- c) Insert the assembly as one piece into the casing [1100].

**Figure 6-16**



- d) Align the containment ring [3830] so that the four inner adapter [1340] bolt holes are on the right and left side of the pump (Figure 6-17).
- e) Insert and tighten (6) socket head cap screws [6570.1] with lock washers [6541]. Torque the socket head cap screws [6570.1] to 27 Nm (20 lbf•ft).

**Figure 6-17**



- f) Align the drive end and push it straight in until it meets the wet end.
- g) Tighten the four adapter socket head cap screws and torque to 27 Nm (20 lbf•ft).

### 6.11.2 In Shop Assembly



Thoroughly clean all parts before assembly. Make sure all parts are free of dirt, metallic particles, etc.

- a) With the casing [1100] face down, insert the impeller [2200].
- b) When the impeller [2200] is in place, rotate it by hand to make sure it spins freely.
- c) Align the shaft [2100] in the containment shell [3500] with the bushing [3300] and lower the containment shell [3500] into place.
- d) Place the containment ring [3830] over the containment shell [3500] (refer to Figure 6-4).
- e) Align the containment ring [3830] so that the four inner adapter [1340] bolt holes are on the right and left side of the pump (refer to Figure 6-17).
- f) Insert six socket head cap screws [6570.1] with lock washers [6541] into the six containment ring [3830] bolt holes.
- g) Tighten the six socket head cap screws [6570.1] with an 8 mm (5/16 in.) hex key and torque to 27 Nm (20 lbf•ft).

## 6.12 Drive End Disassembly



**CAUTION**

The outer magnet assembly [0230] contains very strong magnets. Use caution inserting the jack screw. Under normal circumstances a visual inspection and wiping clean the inside of the outer magnet is sufficient.

### 6.12.1 NEMA Drive End Disassembly

- a) Remove the metal pipe plug [6569] from the top of the adapter [1340].

- b) Locate and loosen the (2) set screws on the on the outer magnet assembly [0230] with a 3/16 in. T-Handle allen wrench.

**Figure 6-18**



- c) Insert a 1/2 in. - 13 x 6+ in. jack bolt into the center of the NEMA outer magnet assembly [0230].
- d) Using a 3/4 in. socket spanner (wrench), tighten the jack bolt to free the outer magnet assembly.

**Figure 6-19**

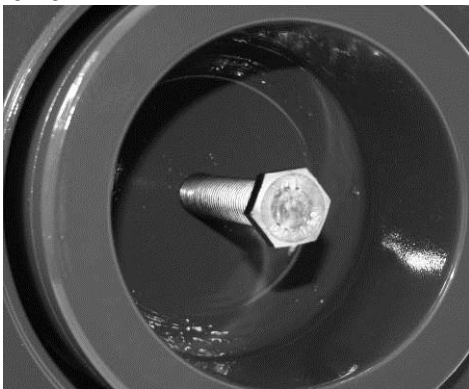

- e) Carefully remove the outer magnet assembly [0230].
- f) Remove (4) screws from the adapter [1340].
- g) Remove the adapter [1340] from the motor.

**6.12.2 IEC Drive End Disassembly**

- a) Remove the metal pipe plug [6569] from the top of the adapter [1340].
- b) Locate and loosen the (2) set screws on the on the outer magnet assembly [0230] with a 5mm T-Handle allen wrench as shown in Figure 6-18.
- c) Attach the jack screw plate [TLG-2042-SI] with (2) M8 x 1.25 x 30 mm screws into the treaded holes inside the IEC outer magnet assembly [0230].

**Figure 6-20**

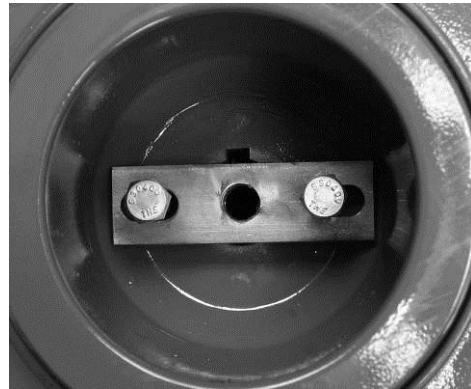
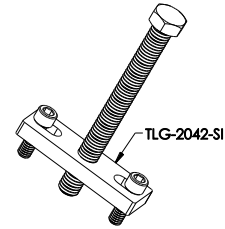

- d) Insert a M12 x 1.75 x 100+ mm jack bolt into the center of the jack screw plate [TLG-2042-SI] and tighten the center jack bolt to free the outer magnet assembly [0230].
- e) Carefully remove the outer magnet assembly [0230].
- f) Remove (4) screws from the adapter [1340].
- g) Remove the adapter [1340] from the motor.

**6.13 Drive End Assembly**

**CAUTION** The Outer Magnet Assembly [0230] contains very strong magnets.

**CAUTION** Do not use blunt force on front face of the outer magnet assembly. If difficult, verify motor shaft meets manufacture's tolerances and is free of burrs.

**6.13.1 NEMA Drive End Assembly**

- a) Align the (4) holes on the support foot [3134] with the (4) holes on the adapter [1340].
- b) Insert and tighten the (4) riser screws.
- c) Line up the adapter [1340] holes with the threaded holes on the motor.
- d) Insert (4) bolts [6570.1] with lock washers [6541] and tighten until no gap is present between the adapter [1340] and the motor mounting face.
- e) Note the placement of the set screws on the outer magnet assembly [0230] in relation to the drive pins before installation. Set screw (A) will be

directly across from the drive pins. Set screw (B) will be perpendicular to the drive pins.

**Figure 6-21**

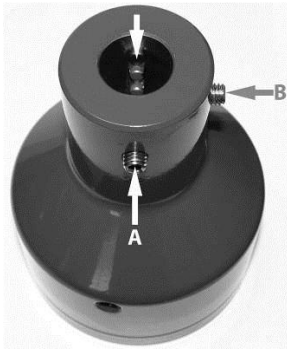

- f) Align outer magnet assembly [0230] drive pins with the key groove on the motor shaft.
- g) Use a ruler, straight edge or visually align the groove on the outer magnet assembly [0230] with the outer edge of the adapter [1340].

**Figure 6-22**



- h) Remove metal plug [6569] from the top of the adapter [1340].
- i) Looking through the top plug hole on the adapter [1340], line up the row of drive pins on the outer magnet assembly [0230] with the hole as shown in Figure 6-23.

**Figure 6-23**



- j) Rotate the outer magnet assembly [0230] by 180°. Visually inspect concentricity of the outer magnet assembly [0230] with adapter [1340].
- k) Tighten the visible set screw (A) as shown in Figure 6-18.
- l) Rotate the outer magnet assembly [0230] 90° counterclockwise to locate and tighten set screw (B).
- m) Install the metal plug [6569] on the adapter [1340].

**6.13.2 IEC Drive End Assembly**



The IEC adapter requires the installation of dowel pins for the following motor sizes: 100L and 112M. The pin installation is permanent. Check the configuration for your motor before you begin.

- a) IEC 80 & IEC 90 do not require dowel pins.
- b) IEC 100L and 112M require (6) dowel pins installed into the unpainted dowel pin holes. Firmly pound the (6) dowel pins in with a hammer until they are firmly seated. The properly installed dowel pin will be flush with the adapter [1340] face.

**Figure 6-24**

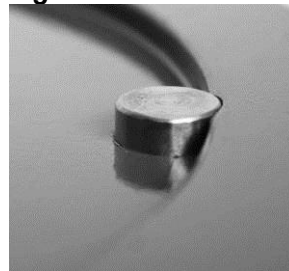

**Figure 6-25**



- c) IEC 132 motors require an adapter plate. To install, align the inner holes on the adapter plate with the holes on the bottom of the adapter [1340]. Insert and tighten the (4) bolts to the adapter plate.

**Figure 6-26**





- d) Once properly configured, align the (4) holes on the riser block with the (4) holes on the adapter [1340].
- e) Align the (4) holes on the support foot [3134] with the (4) holes on the riser block.
- f) Insert and tighten the (4) riser screws.
- g) Align the bolt holes on the motor with the threaded holes on the adapter [1340] or adapter plate (if installed).
- h) Insert and tighten the (4) bolts [6570.1] with lock washers [6541] through the motor flange into the adapter [1340] or adapter plate, if equipped.
- i) Remove plug [6569] from the adapter [1340].
- j) Note the placement of the set screws on the outer magnet assembly [0230] in relation to the key notch before installation. Set screw (A) will be directly across from the key notch. Set screw (B) will be perpendicular to the key notch.

Figure 6-27

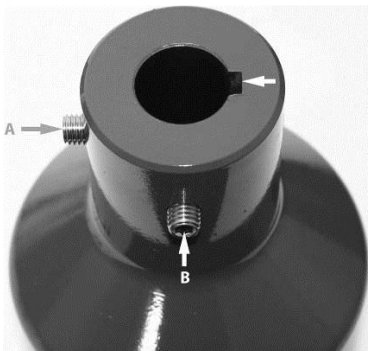

- k) Make sure a key is installed in the motor shaft keyway. Align the key groove on the outer magnet assembly [0230] with the key on the motor shaft and install.
- l) Use a ruler, straight edge or visually align the groove on the outer magnet assembly [0230] with the outer edge of the adapter [1340].
- m) Look inside the outer magnet assembly [0230] and rotate it until the motor key points away from the plug hole. Set screw (A) should now be visible through the hole on the adapter [1340].

Figure 6-28



- n) Tighten set screw (A) with the 5 mm T-handle allen wrench.

Figure 6-29



- o) Rotate the outer magnet assembly [0230] by 90° counterclockwise to locate and tighten set screw (B).
- p) Replace the metal plug [6569] on the adapter [1340] and drive end assembly is complete.

## 6.14 Wet / Drive End Assembly



Assembling the close-coupled motor requires significant care. The magnetic coupling between the impeller and outer drive magnets is very strong. It is recommended to have a second person with non-metallic spacers to place between the adapter [1340] and containment ring [3830] to assist in assembly.

### 6.14.1 Piped Up Assembly

- a) Line up the drive end with the wet end, ensuring proper motor and adapter height relative to the wet end.
- b) Carefully slide the motor forward until it engages with the containment ring [3830] without a gap.
- c) Insert and tighten the (4) socket head cap screws to hold the adapter to the wet end. Torque the socket head cap screws to 27 Nm (20 lbf•ft).
- d) Insert and tighten any support foot [3134] and motor foot screws to secure the assembly to the base.

### 6.14.2 In-Shop Assembly

- a) Holding the wet end by the suction and/or discharge flange, carefully insert the wet end into the drive end in a straight line as shown in Figure 6-30.
- b) Insert and tighten the (4) socket head cap screws to hold the adapter to the wet end. Torque the socket head cap screws to 27 Nm (20 lbf•ft).

Figure 6-30



## 6.15 Gasoline Engine

**Note:** Innomag products are only compatible with certain gasoline engine designs. Contact your local Flowserve Sales office, Distributor, or Representative for further details.

### 6.15.1 Gasoline Engine Disassembly

- a) Follow the steps for NEMA drive end disassembly in section 6.12.1 to remove the wet end and outer magnet assembly [0230].
- b) Remove (4) screws from the adapter [1340].
- c) Remove the adapter [1340] from the engine mounting plate.
- d) Loosen and remove the (4) small socket head cap screws on the mounting plate.
- e) Remove the mounting plate from the engine.

### 6.15.2 Gasoline Engine Assembly

- a) Center the mounting plate on the engine and align the holes.
- b) Insert and tighten the (4) socket head cap screws connecting the mounting plate to the engine.
- c) Follow the steps for the NEMA drive end assembly in section 6.13.1 to complete assembly.

Figure 6-31

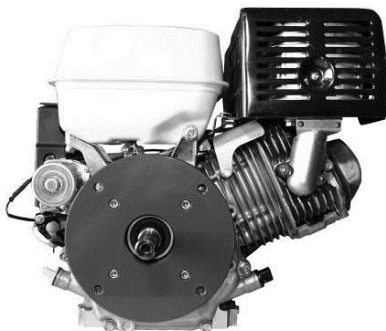









## 8 PARTS LISTS AND DRAWINGS

### 8.1 Sectional drawing

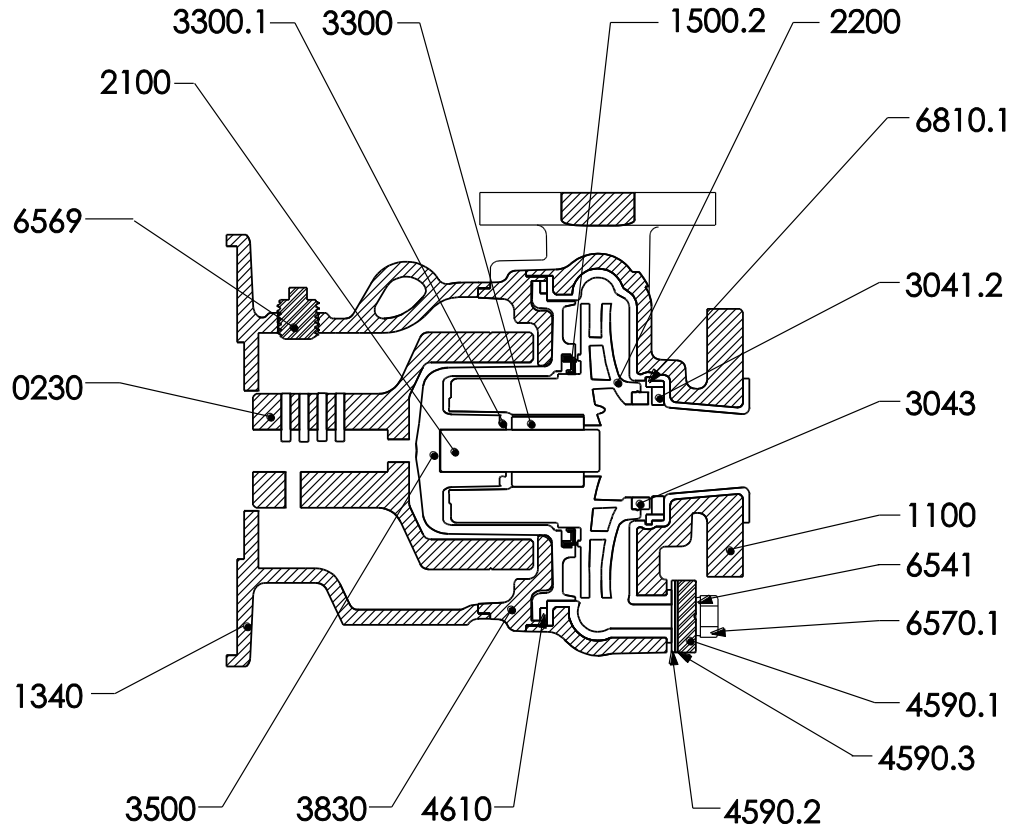

HI #	FIN #	Part	HI #	FIN #	Part
1	1100	Casing	73	4610	O-Ring
2	2200	Impeller Magnet Assembly	231	3500	Shell, Containment
6	2100	Shaft	232	0230	Magnet Assembly, Outer
8a	3043	Wear Ring, Front Rotating	235	3300	Bushing, Bearing
9a	6810.1	Retaining Ring, Front Stationary	239	3830	Ring, Containment
9b	6810.2*	Retaining Ring, Back Stationary	300	6570.1	Screw
14	3300.1	Valve, Thrust Control	301	6541	Lock Washer
19	1340	Adapter	302	6569	Plug
20	3134*	Support Foot	370	4590.1	Drain Flange
27	1500.2	Wear Ring, Back Stationary (Particulate Control Ring)	371	4590.2	PTFE Drain Gasket
72	3041.2	Thrust Collar	372	4590.3	Neoprene Drain Gasket

\*Not shown in diagram

## 8.2 Parts interchangeability

DRIVE END			WET END				
Motor Frame (NEMA/IEC)	Mounting Plate (Close Coupled NEMA/IEC)	Adapter (NEMA/IEC Close Coupled with Riser)	Outer Magnet Assembly (NEMA & IEC)	Containment Ring	Containment Shell Assembly (Includes: Pump Shaft, Wear Ring & Gasket)	Complete Impeller Assembly (Includes: Wear Ring & Bushing)	Casing Assembly (Includes: Wear Ring, Thrust Collar)
A - 56C		ADP-0900-SI	MAO-0901-SI	RGC-0900-SI	SIC-0900-001-AA	IMA-0900-000-AA	CSG-0905-000-AA U0 - (1.5 x 1 x 5")
B - 143/5TC			MAO-0902-SI				CSG-0905-000-LA UL - (1.5 x 1 x 5") Low Flow
C - 182/4TC			MAO-0904-SI				CSG-0905-000-MA UM - (1.5 x 1 x 5") Low Flow
D - 213/5TC			MAO-0905-SI				CSG-0905-000-NA UN - (1.5 x 1 x 5") Low Flow
D1 - 213/5TC, High Torque			MAO-0908-SI				CSG-0910-000-AA U1 - (2 x 1.5 x 6")
E1 - 254/6TC, High Torque			MAO-0907-SI				CSG-0930-010-AA U3 - (3 x 2.5 x 6")
X - For 1" shaft (Honda motor)			MAO-0906-SI				CSG-0940-000-AA U4 - (2.5 x 2 x 6")
X1 - For 1" shaft, High Torque	ADP-1200-SI		MAO-0909-SI				
2 - For 1.25" shaft (hydraulic motor)	ADP-1210-SI		MAO-0920-SI				
21 - For 1.25" shaft, High Torque			MAO-0921-SI				
M - 80		ADP-0905-SI	MAO-0911-SI				
N - 90S/L			MAO-0912-SI				
P - 100L/112M			MAO-0914-SI				
R - 132S/M			MAO-0915-SI				
RI - 132S/M, High Torque	ADP-0910-SI		MAO-0916-SI				

U-MAG™

6" (160mm)

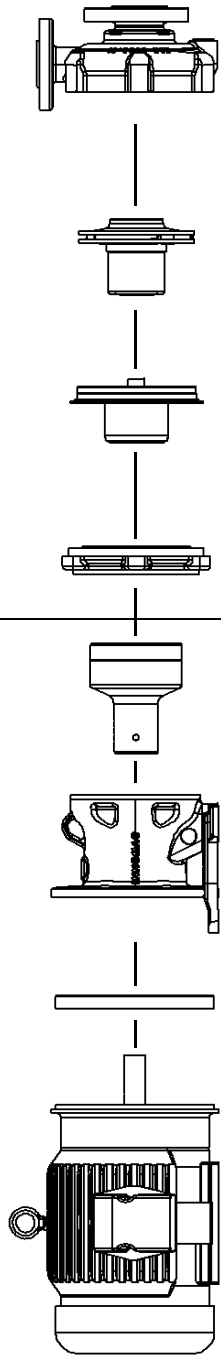

1. - Metric Pump/Parts shown in gray
2. - Part numbers shown are for standard options.
3. - Not all configurations are listed, consult factory for details.

Rev. Date: 5/19/2014



### 8.3 General arrangement drawing

The typical general arrangement drawing and any specific drawings required by the contract will be sent to the Purchaser separately unless the contract specifically calls for these to be included into the User Instructions. If required, copies of other drawings sent separately to the Purchaser should be obtained from the Purchaser and retained with these User Instructions.

## 9 CERTIFICATION

Certificates determined from the Contract requirements are provided with these Instructions where applicable. Examples are certificates for CE marking, ATEX marking etc. If required, copies of other certificates sent separately to the Purchaser should be obtained from the Purchaser for retention with these User Instructions.

## 10 OTHER RELEVANT DOCUMENTATION AND MANUALS

### 10.1 Supplementary User Instruction manuals

Supplementary instruction determined from the contract requirements for inclusion into User Instructions such as for a driver, instrumentation, controller, sub-driver, seals, sealant system, mounting component etc are included under this section. If further copies of these are required they should be obtained from the purchaser for retention with these User Instructions.

Where any pre-printed set of User Instructions are used, and satisfactory quality can be maintained only by avoiding copying these, they are included at the end of these User Instructions such as within a standard clear protection envelope.

### 10.2 Change notes

If any changes, agreed with Flowserve Solution Group, are made to the product after its supply, a record of the details should be maintained with these User Instructions.

### 10.3 Additional sources of information

*Reference 1:*

NPSH for Rotodynamic Pumps: a reference guide, Europump Guide No. 1, Europump & World Pumps, Elsevier Science, United Kingdom, 1999.

*Reference 2:*

Pumping Manual, 9<sup>th</sup> edition, T.C. Dickenson, Elsevier Advanced Technology, United Kingdom, 1995.

*Reference 3:*

Pump Handbook, Igor J. Karassik et al, McGraw-Hill Inc., New York, 1993.

*Reference 4:*

ANSI/HI 5.1-5.6 Sealless Rotodynamic Pumps for Nomenclature, Definitions, Application, Operation, and Test

*Reference 5:*

ANSI B31.3 - Process Piping.

**Your Flowserve factory contact:**

Flowserve INNOMAG® Sealless Pumps  
409 S. Vista Ave.  
Addison, IL 60101

Phone: (630) 543-4240  
Fax: (630) 543-4245

Email: [InnomagSales@flowserve.com](mailto:InnomagSales@flowserve.com)

**Your local Flowserve representative:**

Flowserve Pump Division  
3900 Cook Boulevard  
Chesapeake  
VA23323-1626 USA

Telephone +1 757 485 8000  
Fax +1 757 485 8149

Flowserve Pumps  
Flowserve GB Limited  
Lowfield Works, Balderton  
Newark, Notts NG24 3BU  
United Kingdom

Telephone (24 hours): +44 1636 494 600  
Sales & Admin Fax: +44 1636 705 991  
Repair & Service Fax: +44 1636 494 833

Email: [newarksales@flowserve.com](mailto:newarksales@flowserve.com)

*To find your local Flowserve representative please  
use the Sales Support Locator System found at  
[www.flowserve.com](http://www.flowserve.com)*

**FLOWSERVE REGIONAL  
SALES OFFICES:****USA and Canada**

Flowserve Corporation  
5215 North O'Connor Blvd.,  
Suite 2300  
Irving, Texas 75039-5421, USA  
Telephone +1 937 890 5839

**Europe, Middle East, Africa**

Flowserve Corporation  
Parallelweg 13  
7878 AH Etten-Leur  
The Netherlands  
Telephone +31 76 502 8100

**Latin America**

Flowserve Corporation  
Martin Rodrigues 4460  
B1644CGN-Victoria-San  
Fernando  
Buenos Aires, Argentina  
Telephone +54 11 4006 8700  
Fax +54 11 4714 1610

**Asia Pacific**

Flowserve Pte. Ltd  
10 Tuas Loop  
Singapore 637345  
Telephone +65 6771 0600  
Fax +65 6862 2329