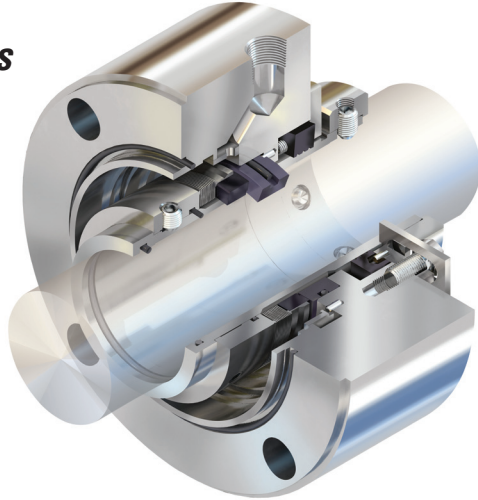

BW Seals[®] BX Series

General Service Bellows Seal
BX, BXLS, BXR, BXQ, BXU

**1 Equipment Check**

- 1.1 Follow plant safety regulations prior to equipment disassembly:
 - 1.1.1 Wear designated personal safety equipment
 - 1.1.2 Isolate equipment and relieve any pressure in the system
 - 1.1.3 Lock out equipment driver and valves
 - 1.1.4 Consult plant Safety Data Sheet (SDS) files for hazardous material regulations
- 1.2 Disassemble equipment in accordance with the equipment manufacturer's instructions to allow access to seal installation area.
- 1.3 Remove existing sealing arrangement (mechanical seal or otherwise). Clean seal chamber and shaft thoroughly.
- 1.4 Inspect surfaces under gaskets to ensure they are free from pits or scratches. Break all sharp corners on shaft steps, threads, reliefs, shoulders, key ways, etc. over which gasket(s) must pass and/or seal against.
- 1.5 Check shaft or sleeve OD, seal chamber bore, seal chamber depth, gland pilot, stud diameter, stud bolt pattern and distance to first obstruction to ensure they are dimensionally the same as shown in the seal assembly drawing.
- 1.6 Check seal assembly drawings for any modifications (reworks) to be made to the equipment for mechanical seal installation and act accordingly.
- 1.7 The equipment must be earthed to prevent sparks due to static electricity discharge.

Shaft runout should be checked against the equipment manufacturer's specifications.

Generally, should not exceed 0.05 mm (0.002 inch) TIR (Total Indicator Reading) at any point along the shaft for ball or roller type bearings. For sleeve type bearings, refer to manufacturer instructions. If the equipment is not completely dismantled, verify runout near seal location.

The above values apply to shaft speeds in the range from 1000 to 3600 RPM. For values above and below, consult your Flowserve representative. See Figure 1.

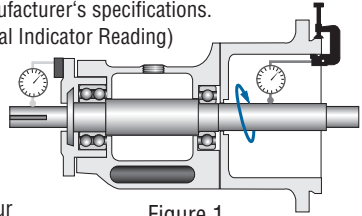

Figure 1

Shaft endplay should not exceed 0.25 mm (0.010 inch) TIR, regardless of thrust bearing type. See Figure 2.

Radial bearing play at seal chamber face should be checked against the equipment manufacturer's specifications. Generally 0.05 - 0.10 mm (0.002 - 0.004 inch) will be applicable for ball or roller type bearings. For sleeve or journal type bearings, values will generally be in the order of 0.10 - 0.15 mm (0.004 - 0.006 inch). If equipment is found outside the general range, contact the equipment manufacturer and your Flowserve representative to verify the equipment's suitability for the seal.

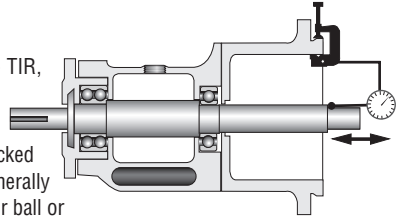

Figure 2

Seal chamber squareness to the shaft centerline should be within 0.0005 mm/mm (0.0005 inch/inch) of seal chamber bore TIR.

Note: make sure that shaft endplay does not affect the reading. Verify the smoothness of the seal chamber face for a good gasket joint. See Figure 3.

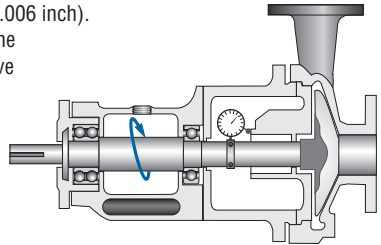

Figure 3

Concentricity of the shaft to the seal chamber bore or gland pilot register should be within 0.025 mm per 25 mm shaft diameter (0.001 inch per 1 inch shaft diameter) to a maximum of 0.125 mm (0.005 inch) TIR. See Figure 4.

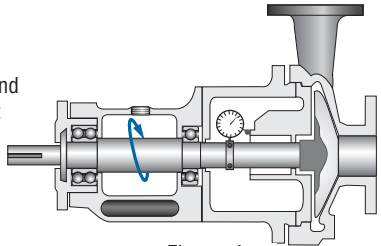
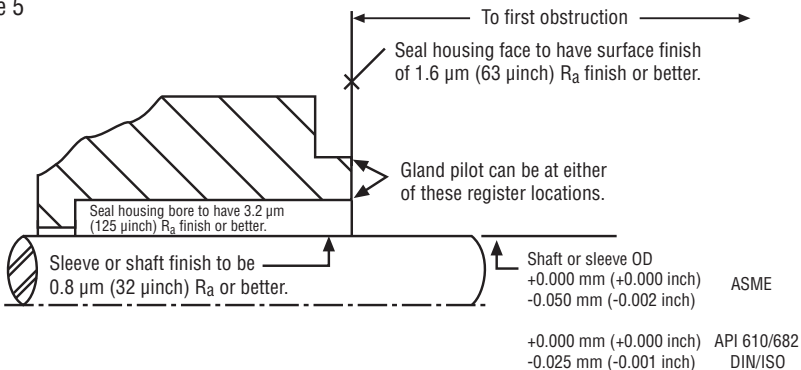

Figure 4

Surface finish requirements

Figure 5



2 Assembly of Seal Components

2.1 Prepare bellows assembly for installation.

- 2.1.1 Install the set screws in bellows assembly.

Caution: Be sure set screws do not protrude into bellows assembly bore which would cause interference when sliding bellows assembly onto shaft.

- 2.1.2 Lubricate and install bellows assembly O-ring, using silicone base grease only, unless otherwise specified on the drawing.

3 Seal Setting for Seal on Shaft or Customer's Sleeve

For proper seal installation, you must obtain the correct seal assembly drawing for your application.

- 3.1 Inspect pump shaft. Clean and remove any burrs, nicks, scratches, etc. which could cause damage to gaskets when assembling seal.
- 3.2 Secure the seal assembly in place at its correct seal setting position (SS) by tightening the rotating assembly set screws. See Figure 2. Refer to the seal assembly drawing for correct seal setting dimension.

Installed Seal Assembly on Shaft or Customer's Sleeve

Figure 6

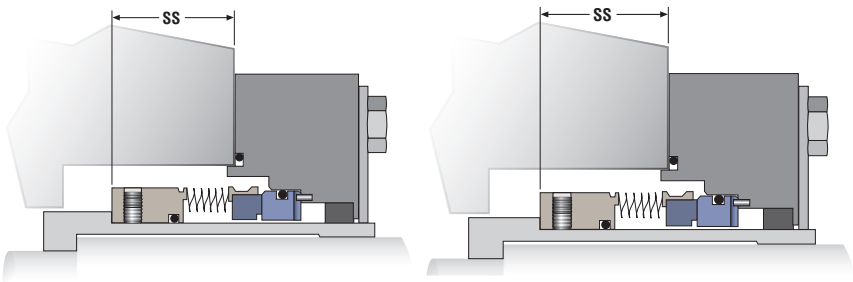

O-ring Mounted Stationary Face

- 3.2.1 Assemble seat gasket to stationary face lubricate gasket with silicone base grease only, unless otherwise specified on seal drawing) and install in gland.

Caution: If anti-rotation pin is used, make sure stationary face is properly seated. Do not get grease on running face.

- 3.2.2 Install gland gasket - Use silicone grease if necessary to retain gasket.

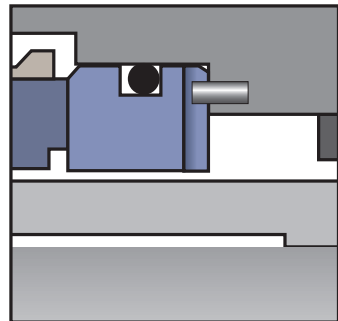

O-ring Mounted Face

The images of parts shown in these instructions may differ visually from the actual parts due to manufacturing processes that do not affect the part function or quality.

Clamped Stationary Face

- 3.2.3 Install flat gasket into gland.
- 3.2.4 Install stationary face into gland.
- 3.2.5 Install second flat gasket to stationary face.

Note: If two gasket materials are supplied, install PTFE gasket at this location. Use the lubricant provided to retain gasket if necessary. **Do not** get grease on running face.

L-Shaped Stationary Face (BXLS)

- 3.2.6 Assemble seat gasket to stationary face. Lubricate gasket with the lubricant provided and install in gland.

Caution: If anti-rotation pin is used, make sure stationary face is properly seated. **Do not** get grease on running face.

- 3.2.7 Install gland - Use the lubricant provided if necessary to retain gasket.

- 3.3 **Using lint free tissue, clean stationary and rotating face** mating surfaces. Alcohol or acetone can be used as a cleaning agent to assure clean, film free, dry faces. Any other materials may cause premature seal failure.

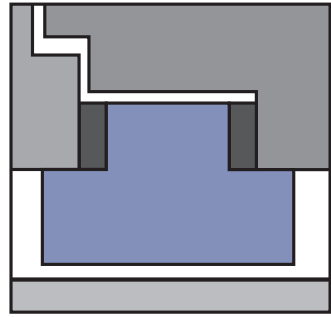

Clamped Mounted Face

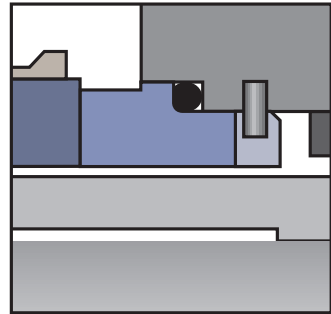

L-Shaped Mounted Face

Caution: Consult material safety data sheets for proper handling of alcohol or acetone.

- 3.4 Assemble gland to seal chamber face. See Figure 6.

Caution: During gland assembly over shaft, be sure stationary face is not damaged. Secure bolts attaching gland to housing.

Note: Even torque is required on all flange bolts to assure proper seal operation.

4 Hook Sleeve Mount

For proper seal installation. You must obtain the correct seal assembly drawing for your application.

- 4.1 **Inspect pump shaft.** Clean and remove any burrs, nicks, scratches, etc. which could cause damage to gaskets when assembling seal.
- 4.2 **Assemble shaft sleeve and flat gasket** to pump shaft and seat in accordance with pump manufacturer's specifications. Inspect for and remove any burrs.
- 4.3 **Verify seal setting (SS)** reference dimension on the seal drawing. This is the dimension from the seal chamber face to a machined step or locator on the shaft. See Figure 7.
- 4.4 If shaft sleeve has no locating shoulder, blue sleeve and scribe line for location of spring holder as shown on assembly drawing.
- 4.5 **Slide rotating assembly** onto shaft sleeve, locating in accordance with the seal assembly drawing. Use caution not to dislodge rotating gasket.

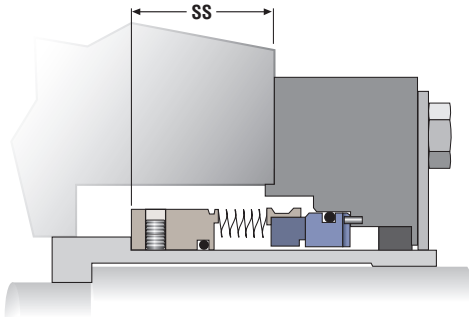

4.6 **Tighten seal assembly** set screws to shaft sleeve insuring seal assembly is retained at proper seal setting location as noted on seal assembly drawing.

O-ring Mounted Stationary Face

4.6.1 Assemble seal gasket to stationary face. Lubricate gasket with the lubricant provided and install in gland.

Caution: If anti-rotation pin is used make sure stationary face is properly seated.

Do not get grease on running face.

4.6.2 Install gland gasket, use the lubricant provided if necessary to retain gasket. See O-ring mounted face.

Clamped Stationary Face

4.6.3 Install flat gasket into inner gland.

4.6.4 Install stationary face into gland.

4.6.5 Install second flat gasket to stationary face.

Note: If two gasket materials are supplied, install PTFE gasket at this location.

Use the lubricant provided to retain gasket if necessary.

Do not get grease on running face. See clamped mounted face.

L-Shaped Stationary Face

4.6.6 Assemble seat gasket to stationary face (lubricate gasket with the lubricant provided and install in gland).

Caution: If anti-rotation pin is used, make sure stationary face is properly seated.

Do not get grease on running face.

4.6.7 Install gland gasket - Use silicone grease if necessary to retain gasket.

4.7 **Using lint free tissue, clean stationary and rotating face** mating surfaces. Alcohol or acetone can be used as a cleaning agent to assure clean, film free, dry faces. Any other materials may cause premature seal failure.

Caution: Consult material safety data sheet for proper handling of alcohol or acetone.

4.8 **Assemble gland to seal chamber face.** See Figure 7.

Caution: During gland assembly over shaft and sleeve, be sure stationary face is not damaged. Secure bolts attaching gland to housing.

Note: Even torque is required on all gland bolts to assure proper seal operation.

5 Cartridge Mounted

- 5.1 **For proper seal installation**, you must obtain the correct seal assembly drawing for your application.
- 5.2 **Inspect pump shaft.** Clean and remove any burrs, nicks, scratches, etc., which could cause damage to gaskets when installing cartridge seal. Ensure gland and sleeve gaskets are installed. It may be necessary to lubricate the shaft with grease to prevent damage to sleeve gasket during installation.
- 5.3 Carefully install the seal onto the shaft and locate against the face of the seal chamber. Take care not to impact the seal cartridge as damage to internal components can occur.
- 5.4 Orient ports on the seal cartridge as shown on the seal assembly drawing.
- 5.5 Evenly torque gland bolts/nuts to prevent uneven gland pressure against the seal chamber.
- 5.6 Adjust bearings, coupling, and impeller so that the shaft is in its final operating position.
- 5.7 Setting Devices
 - A - Type 1 (none)
 - B - Type 2 (setting plates)
 - C - Type 3 (setting blocks)

Type 1 (none)

Figure 8

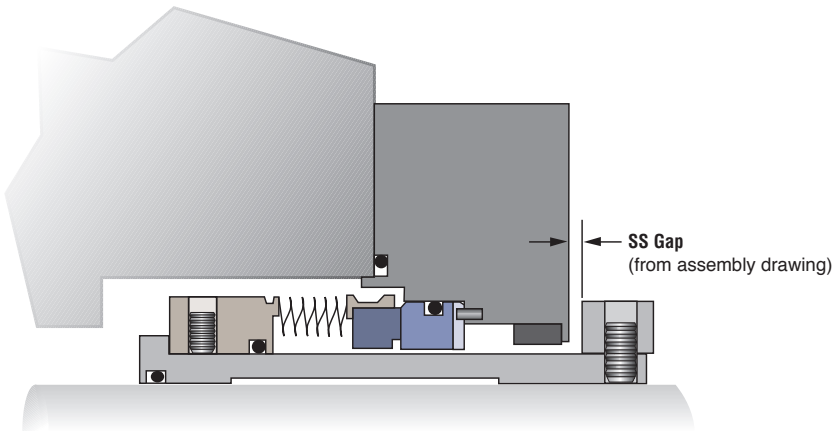

- Determine proper seal setting (SS) gap specified in seal assembly drawing.
- Adjust sleeve drive collar position relative to gland to establish proper gap.
- Tighten drive collar set screws.

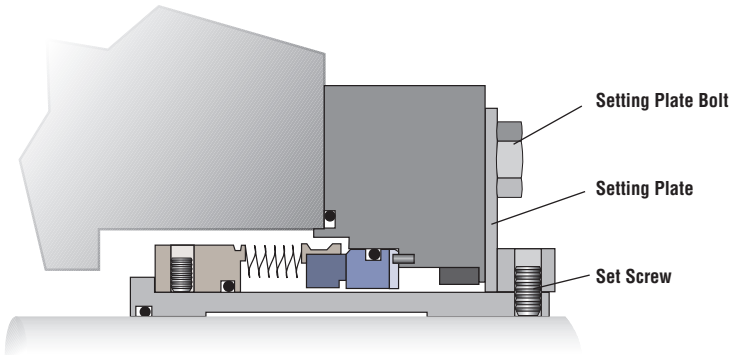

- Tighten drive collar set screws to shaft.
- Loosen setting plate attachment bolts and rotate setting plates clear of drive collar.
- Retighten setting plate attachment bolts with setting plates clear of drive collar.

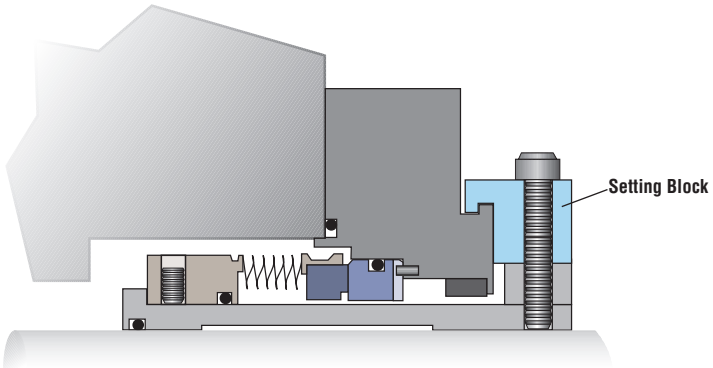

- Tighten drive collar set screws to shaft.
- Loosen and remove setting blocks.

6 Piping Instructions

Do not start up the equipment dry.

Vent air from the casing of the pump and the seal chamber before start-up.

Refer to seal assembly drawing for mechanical seal piping instructions.

Note: For special problems encountered during installation, contact your nearest Flowserve Sales and Service Representative or Authorized Distributor.



TO REORDER REFER TO

B/M # _____

F.O. _____

7 Repair

This product is a precision sealing device. The design and dimension tolerances are critical to seal performance. Only parts supplied by Flowserve should be used to repair a seal.

To order replacement parts, refer to the part code and B/M number. A spare backup seal should be stocked to reduce repair time.

When seals are returned to Flowserve for repair, **decontaminate the seal assembly** and include an order marked **"Repair or Replace."** **A signed certificate of decontamination** must be attached.

A Safety Data Sheet (SDS) must be enclosed for any product that came in contact with the seal. The seal assembly will be inspected and, if repairable, it will be rebuilt, tested, and returned.

FIS148eng REV 09/2018 Printed in USA

To find your local Flowserve representative
and find out more about Flowserve Corporation,
visit www.flowserve.com

Flowserve Corporation has established industry leadership in the design and manufacture of its products. When properly selected, this Flowserve product is designed to perform its intended function safely during its useful life. However, the purchaser or user of Flowserve products should be aware that Flowserve products might be used in numerous applications under a wide variety of industrial service conditions. Although Flowserve can provide general guidelines, it cannot provide specific data and warnings for all possible applications. The purchaser/user must therefore assume the ultimate responsibility for the proper sizing and selection, installation, operation, and maintenance of Flowserve products. The purchaser/user should read and understand the Installation Instructions included with the product, and train its employees and contractors in the safe use of Flowserve products in connection with the specific application.

While the information and specifications contained in this literature are believed to be accurate, they are supplied for informative purposes only and should not be considered certified or as a guarantee of satisfactory results by reliance thereon. Nothing contained herein is to be construed as a warranty or guarantee, express or implied, regarding any matter with respect to this product. Because Flowserve is continually improving and upgrading its product design, the specifications, dimensions and information contained herein are subject to change without notice. Should any question arise concerning these provisions, the purchaser/user should contact Flowserve Corporation at any one of its worldwide operations or offices.

© 2015 Flowserve Corporation

USA and Canada

Kalamazoo, Michigan USA
Telephone: 1 269 381 2650
Telefax: 1 269 382 8726

Europe, Middle East, Africa

Etten-Leur, the Netherlands
Telephone: 31 765 028 200
Telefax: 31 765 028 487

Asia Pacific

Singapore
Telephone: 65 6544 6800
Telefax: 65 6214 0541

Latin America

Mexico City
Telephone: 52 55 5567 7170
Telefax: 52 55 5567 4224