

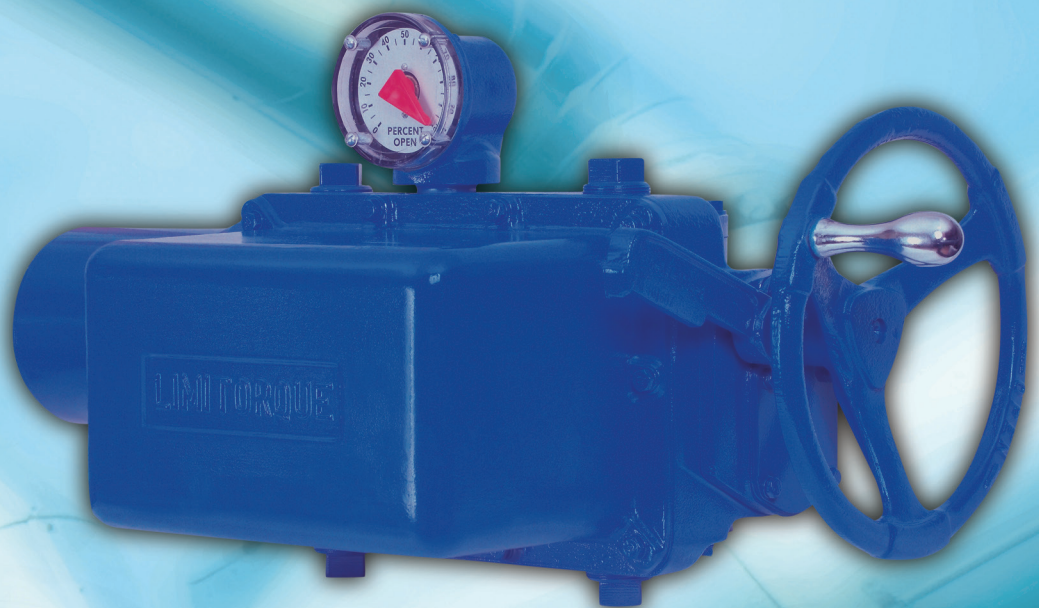

Limitorque® SMB Series Multi-Turn Electric Actuator

Durable construction for the toughest applications



Experience In Motion

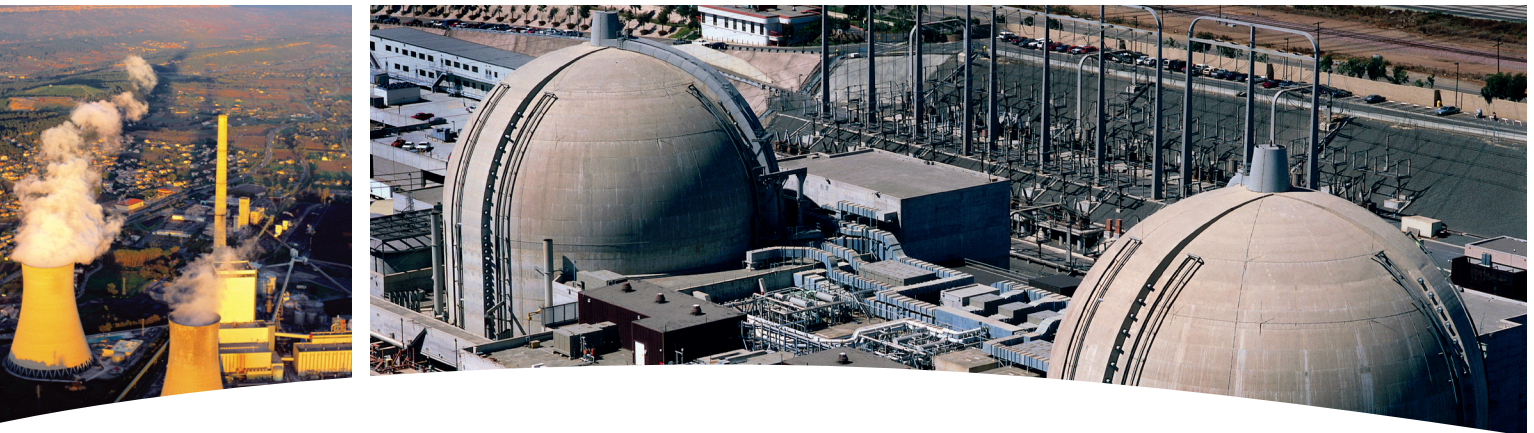

Flowserve Limatorque SMB multi-turn actuators: when maximum service life is a must

When an actuator offering unsurpassed strength and durability is required, choose a five-decade veteran of the nuclear power industry: the Flowserve Limatorque SMB series. The extraordinarily solid construction of these actuators provides a service life of often more than 30 years. All SMB housings are rugged cast or ductile iron. Weatherproof construction is standard. SMB actuators are also available for XP, Navy Class A, and nuclear requirements.

Clearly capable

The SMB series covers a broad scope of capabilities, producing torque ranging from 15 ft-lb (20 N m) to 60,000 ft-lb (81,349 N m), and handling stem thrusts up to 500,000 lbs (2,224 kN). As a result, the Limatorque SMB family makes valve control easier whenever the application demands maximum durability.

The SMB has earned its credentials in some of the most critical and strenuous applications around the world. Limatorque actuators are at work on every US Navy nuclear aircraft carrier. For the Metropolitan Water District of Southern California, Limatorque actuators operate the massive 50-ton, 10-foot-diameter butterfly valves controlling the flow of water into Los Angeles. And 300 feet beneath the streets of New York City, Limatorque actuators control 96-inch water valves that are subjected to 750,000 ft-lb of torque. SMB actuators excel in the harsh environments of refinery cokers.

Advanced adaptability

Spring-compensated versions of the SMB (designated SB and SBD), are available for applications where thermal expansion may pose a jammed-valve risk, or where valve discs are subject to extremely high-speed closure.

The SMB is also a perfect choice for customizing to meet special requirements. Many SMBs have been adapted to control mechanical equipment other than valves in applications requiring precise, powerful linear or rotary motion.

A proven performer in the most demanding fields

With its durable cast-iron housing, the SMB has long been a mainstay of the nuclear power industry. It was the first actuator to be tested and approved for nuclear power plant reactor containment service. SMB actuators are in service in every major nuclear power generation facility in the world, and on most of the world's nuclear naval vessels.

And while the SMB is a veteran of the nuclear power field, this actuator's brawn has proved valuable to many other industries as well. It can capably serve in such applications as:

- Oil and gas wells and platforms
- Oil and gas pipelines
- Petroleum distribution terminals and tank farms
- Petrochemical refineries and hydrocarbon processing plants
- Chemical and specialty chemical plants
- Fossil fuel and nuclear power plants
- Hydroelectric facilities
- Water and wastewater treatment plants
- Dams and flood gates
- Aqueducts and other water distribution systems
- Steam distribution systems
- Mines and ore refineries
- Steelworks and other metals processing plants
- Pulp/paper mills

Engineered for reliable, long-term performance

Encased in a rugged cast iron or ductile iron housing, the SMB is built for exceptional durability inside and out.

At the core of the SMB is a double-reduction gear set (helical and worm), available in several combinations, that assures exemplary performance and eliminates “speed vs. torque” sizing trade-offs.

For positive, reliable actuation, a “hammer-blow” feature allows the motor to reach full speed before the load is engaged — enabling the actuator to apply appropriate force to the valve shaft. The power of the SMB is tamed by its automatic torque-limiting feature, which de-energizes the motor in the event of an obstruction to prevent damage to the valve.

A geared limit switch controls valve travel during both opening and closing movements of the valve stem. (This limit switch also activates position indicator lights for “open” and “closed” status.) The SMB’s position and torque limit switches are housed in a compartment designed to give technicians easy access to the switches and wiring terminals for simpler installation, startup, and maintenance.

From end to end, the SMB embodies sensible design and solid construction.

This cutaway diagram highlights just a few features that contribute to the outstanding reliability of the SMB.

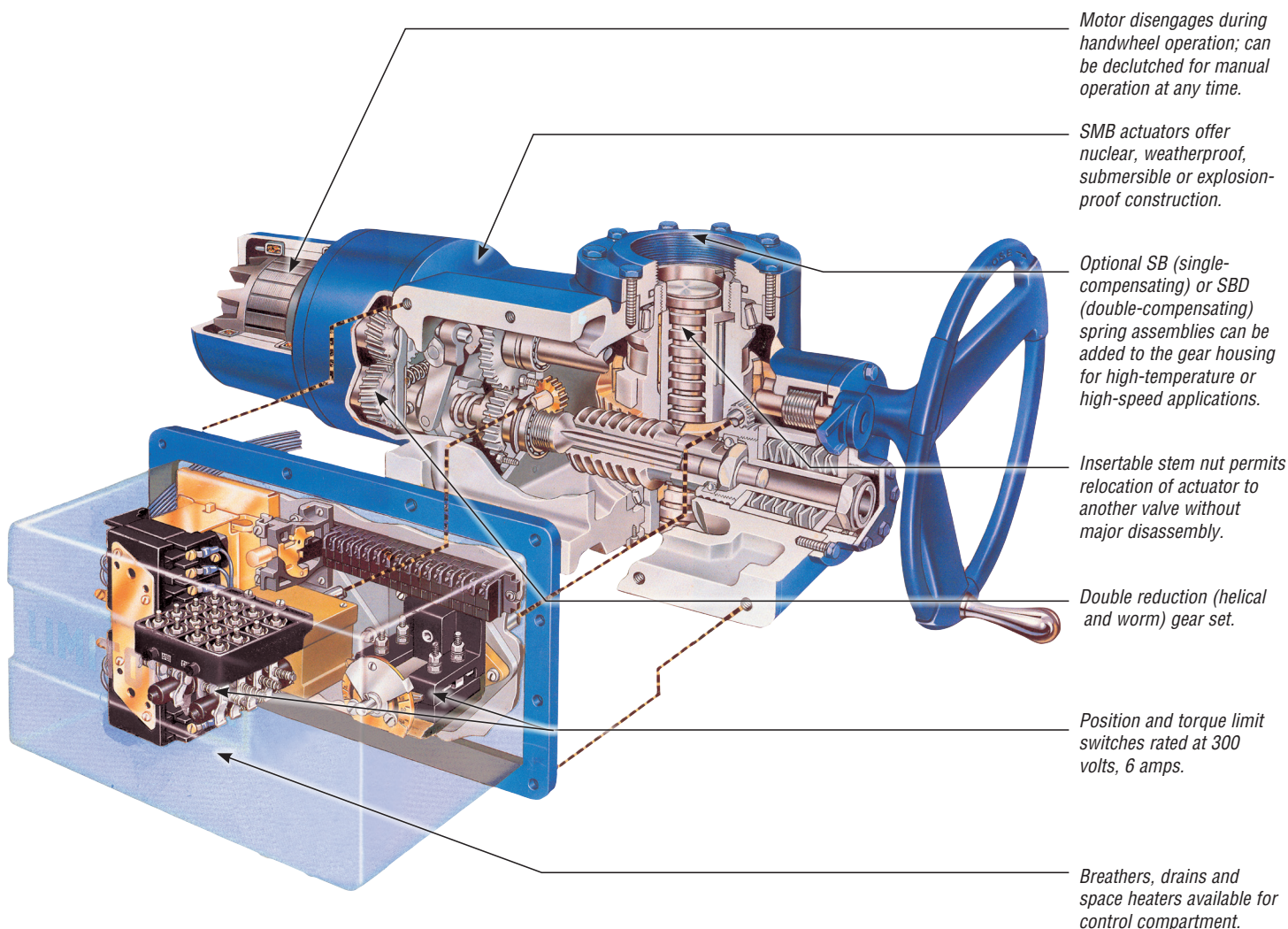

A single family of actuators capable of handling an extraordinarily broad range of applications

SMB-000 and SMB-00 The smaller SMBs contain all of the main features of the larger SMB actuators, but are designed for valves requiring lower operating torque and thrust.

SMB-0 through SMB-3 These larger SMB actuators are designed to accept larger stem capacities and develop more power. Like other members of the SMB line, these can be safely operated manually in the event of power interruption.

SMB-4 and SMB-5 The SMB-4 and SMB-5 offer unequalled capacity for operating large, high-pressure valves. The SMB-5 is available in an economical torque-only configuration, without thrust bearings. This actuator, the SMB-5T, transmits only torque to the valve stem. In this application, thrust must be taken by thrust bearings built into the valve yoke.

SB and SBD options The SB and SBD variations of the standard SMB actuator incorporate a spring-loaded stem nut that permits reliable operation in high-speed or high-temperature service situations. The SB design allows for thermal expansion and contraction of the valve stem and actuator stem nut to maintain proper operation of the valve in high valve temperature applications.

The SB's spring compensation package helps absorb the seating shock accompanying high-speed operation of certain gate and globe valves. The spring assembly allows the SB's stem nut to float upward, absorbing the seating shock caused by rapid closing of the valve. (The springs can also expand to ensure the valve remains firmly seated.) This impact-dampening capability promotes longer life for valves and enables the SB actuators to function at speeds as high as three times normal rates.

In the SBD (double-compensating) configuration, the stem nut can float both upward and downward in response to thermal fluctuations or high speed torque seating. SBD is the choice for stem contraction and torque back-seating applications.

The SB/SBD actuators have the same torque and thrust ratings, gear ratios, and electrical options as the SMB line. They also share the same mounting bases as the standard SMB actuators. This allows SB/SBD actuators to be interchanged with comparably sized SMB actuators in the event that a change in valve conditions requires the use of a spring-compensated actuator.

The SMB family

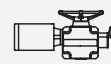

SMB-000 and 00

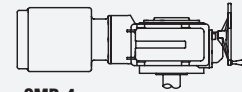

SMB-4

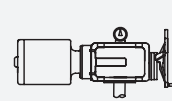

SMB-0 through 3

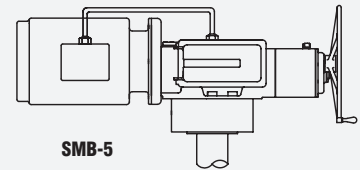

SMB-5

SB and SBD optional packages

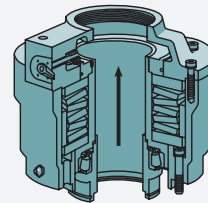

SB (single-compensating)

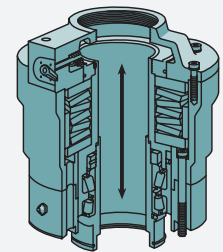

SBD (double-compensating)

A typical SB configuration

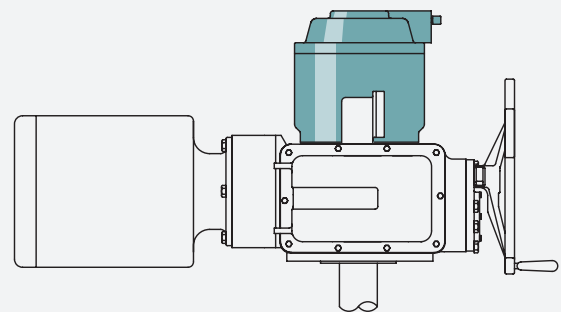

Choices to make valve control easier ... from near or far

The SMB series uses close-coupled control stations, with indicating lights and selector switches, for open, stop, and closed local operation. The SMB's integrated controls can provide output signals to a control room for remote operation.

All SMBs are available with optional integral controls and other features built into the motor/geared limit switch compartment:

- integral reversing motor controllers
- position transmitters
- space heaters
- control voltage transformers
- breathers and drains

(Special electrical packages are available for most control voltages.)

Motors to meet customer needs around the world

Choose from an extensive selection of motors to suit numerous speed and voltage requirements—with Class B, F, H, or nuclear service, high-temperature, radiation-resistant insulation.

A time-saving design detail

All SMB actuators have an insert stem nut that allows the actuators to be transferred from one valve to another without major disassembly. This logical design can save a significant amount of labor should relocation of the SMB to a different valve be required.

Compatible with all types of valves

The SMB easily handles gate, globe, plug, ball, and butterfly valves, as well as specialized valves and mechanisms, such as sluice gates and shipboard watertight doors.

SMBs mount directly to gate and globe valves. Butterfly, ball, and plug valves are typically motorized by mounting the SMB to an additional gearbox to obtain a gear ratio suitable for quarter-turn applications. The SMB accommodates all Limitorque gearboxes including the HBC and WG gearboxes for quarter-turn application, and the V and SR gearboxes for multi-turn applications.

Whatever the valve, the SMB reliably controls valve movement, provides constant seating torque, and automatically compensates for valve wear — so you have long-term assurance that the valve is absolutely tight on each closure.

And by protecting all of the valve's operating parts from torque and thrust overload, the SMB can prevent damaged valve seats, stems, and discs.

Options

Top-mounted and side-mounted mechanical dial position indicators (MDPI adjust for 360 viewing.

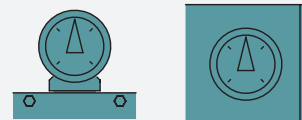

Control Stations

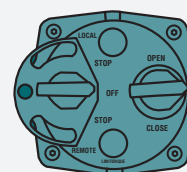

Valve types

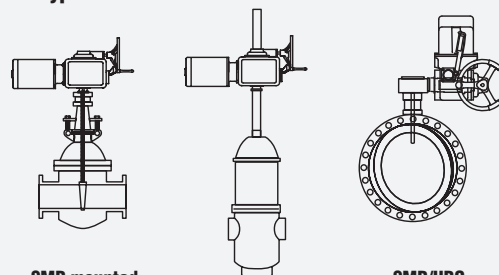

SMB mounted to wedge gate

SMB mounted to thru-conduit gate valve

SMB/HBC mounted to butterfly valve

SMB/Gearhead combinations

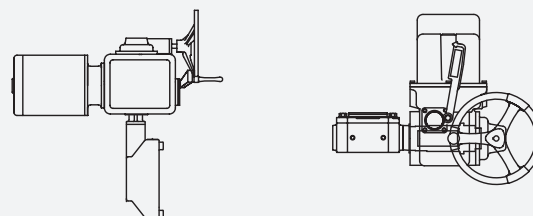

Multi-turn SMB/V

Quarter-turn SMB/HBC, SMB/WG

SMB Standard Product Specification

Gear housing

Housing material – cast iron or ductile iron
Lubrication – MOV long-life EP, NLGI grade 0 grease
Gear reduction – Double reduction type: worm and helical gearing
Worm gear – alloy bronze
Worm – alloy steel
Helical gears – heat-treated steel

Motor

Designation – Example: 60/4P refers to “60 foot-pound – four-pole”. Four-pole is either 1800 RPM (60 Hz) or 1500 RPM (50 Hz); two-pole is either 3600 RPM (60 Hz) or 3000 RPM (50 Hz).
Type – Squirrel-cage induction
Power supply – suitable for 3/60/230v, 460v or 575v; 3/50/380v; or 3/50/415v.
Duty – nominal is 15 minutes. Optional extended duty available.
Dynamic torque – nominal 20% of start torque. Optional dynamic torque at 40% of start torque available.
Insulation – Class F standard
Heater – 120 VAC

Limit switch

Type – gear-driven, snap-acting switch
Contacts – 16 contacts (4 train)
Contact rating – 300 volts per ICS-125.6; current rated 6 amps resistive and 60 amps inrush at 120 VAC

Torque switch

Contacts – One SPST contact each for open and closed direction dedicated to actuator torque protection; nuclear grade
Rating – 300 volts per ICS-125.6; current rated 6 amps resistive and 60 amps inrush at 120 VAC

Seals

Viton

Enclosure

WP actuators – suitable for NEMA 4
XP actuators are suitable for and may be nameplated as:
Factory Mutual: Class 1, Groups C and D, Division 1, and Class II, Groups E, F, G, Division 1 and 2.
Class 1, Group B service is available for most models. Consult factory for specific applications.
CSA: Class 1, Groups C and D, Division 1.

Mounting base

Supplied to MSS (English taps) standard

Paint

LPS-129. Color blue standard. Valspar epoxy/polyurethane.

Temperature rating

-20°F to 150°F (-29°C to 66°C)

Actuator nameplate

Includes the point of manufacture, actuator size, order number, serial number and space for customer tag information. The nameplate also includes the CE stamp. The nameplate is located on the back of the actuator opposite the limit switch compartment.

Motor nameplate

The motor nameplate includes ID number, start torque, run torque, enclosure type, RPM, volts, full load amps, locked rotor amps, insulation class, duty, horsepower, service factor, phase, cycles, motor code, ambient temperature and connection diagram.

Controls

NCU (No Controls Actuator) – No additional controls included
INT (Integral Controls) – Includes transformer and reversing contactor

SMB Commercial and Nuclear Options Product Specification

Local continuous position indication

Local position indicator that shows continuous valve position via a dial that is labeled 0-100% OPEN. Indicator is driven by a dedicated gear set that is selected per the application. The SMB-000/0 includes window-mounted dial in MDPI housing bolted on the back of the actuator. The SMB-0-5 includes window-mounted dial in MDPI housing close-coupled to actuator housing.

Local/remote indication

Includes the Local Continuous Position Indicator with a 1000-ohm potentiometer. The potentiometer is used to transmit valve position to a remote location. One or two potentiometers may be included.

Local/remote nuclear 2000-ohm potentiometer

Includes the Local Continuous Position Indicator with a 2000-ohm, radiation-resistant potentiometer. The potentiometer is used to transmit valve position to a remote location.

Handwheel spur

A spur gear attachment that may be added to the actuator to reduce the effort required to operate the handwheel, but requiring more turns.

Optional handwheels

Used to reduce the effort required to operate the handwheel.

SB/SBD spring compensation

SB type spring-compensated package for use on high-speed, high-temperature torque-seated applications.

Control station

Includes three-position selector switch (open, stop, close), two indicating lights (open, intermediate, close indication), and a three-position selector switch (local, off, remote).

Motor

Optional DC motors are available for some sizes.

Routine motor test

Tests are conducted in accordance with NEMA MG-1 and IEEE-112.

Other XP categories

Consult factory.

Note: All options are non-safety-related.

SMB Nuclear Product Specification

Gear housing

Housing material – cast iron or ductile iron

Lubrication – MOV long-life EP, NLGI grade 0 grease

Gear reduction – Double reduction type: worm and helical gearing

Worm gear – alloy bronze

Worm – alloy steel

Helical gears – heat-treated steel

Motor

Designation – Example: 60/4P refers to “60 foot pound – four-pole”. Four-pole is either 1800 RPM (60 Hz) or 1500 RPM (50 Hz); two-pole is either 3600 RPM (60 Hz) or 3000 RPM (50 Hz).

Type – Squirrel-cage induction

Power supply – suitable for 3/60/230v, 460v or 575v; 3/50/380v; or 3/50/415v.

Duty – nominal is 15 minutes
125/250 VDC, 5 minute duty
Nuclear grade

Dynamic torque – nominal 20% of start torque

Insulation – Class RH

Routine motor test, motor “T” drains

Limit switch

Type – gear-driven, snap-acting switch, nuclear grade

Contacts – 16 contacts (4 train) nuclear grade

Contact rating – 300 volts per ICS-125.6; current rated 6 amps resistive and 60 amps inrush at 120 VAC

Torque switch

Contacts – One SPST contact each for open and closed direction dedicated to actuator torque protection. Nuclear grade Rating – 300 volts per ICS-125.6. Current rated 6 amps resistive and 60 amps inrush at 120 VAC.

Wire

Rockbestos SIS

Seals

Viton

Enclosure

All actuators are suitable for inside or outside containment safety-related service. Three-phase design actuators are qualified per IEEE 323, IEEE 344 and IEEE 382 per Limitorque Test Reports 600376 (BWR) and 600456 (PWR). DC “RH” design actuators are qualified per IEEE 323 and IEEE 382 per Limitorque Test Report B0009.

Mounting base

Supplied to MSS (English taps) standard

Paint

Prime coating of LPS-102A inorganic zinc primer

Actuator nameplate

Includes the point of manufacture, actuator size, order number, serial number and space for customer tag information. The nameplate also includes the CE stamp. The nameplate is located on the back of the actuator, opposite the limit switch compartment.

Motor nameplate

Typical AC motor nameplate information includes ID number, start torque, run torque, enclosure type, RPM, volts, full load amps, locked rotor amps, insulation class, duty, horsepower, service factor, phase, cycles, motor code, ambient temperature and connection diagram.

SMB Performance Ratings

Commercial service ratings*

Model	Output speed range	Max torque rating		Max thrust rating	
		ft-lb	N m	lb	kN
SMB-000	12-250	110/120	149/163	8000	36
SMB-00	10-250	260	353	14,000	62
SMB-0	10-250	700	949	24,000	107
SMB-1	10-250	1100	1491	45,000	200
SMB-2	10-250	1950	2644	70,000	311
SMB-3	10-250	4200	5694	140,000	623
SMB-4	10-250	8300	11,253	250,000	1112
SMB-5 & 5T	12-55	20,000	27,116	500,000 (-5 only)	2224
SMB-5XT	12-55	60,000	N/A	N/A	N/A

* Maximum torque rating is output speed dependent.

Maximum stem capacity

Two-piece nut design (drive sleeve and stem nut)				One-piece design (drive sleeve)		
Max threaded		Max bore and keyway		Max threaded	Max bore and keyway	
Model	in.	in.	mm	in.	in.	mm
SMB-000	1.375	1.125 w/ 1/4 x 3/32	26.0 w/ 8 x 3.5	1.5	1.250 w/ 1/4 x 1/8	31.0 w/ 8 x 3.5
SMB-00	1.75	1.500 w/ 3/8 x 1/8	37.0 w/ 10 x 4	2	1.750 w/ 3/8 x 3/16	44.5 w/ 14 x 4.5
SMB-0	2.375	1.875 w/ 1/2 x 3/16	47.6 w/ 14 x 4.5	2.75	2.313 w/ 5/8 x 7/32	58.8 w/ 18 x 5.5
SMB-1	2.875	2.438 w/ 5/8 x 7/32	61.9 w/ 18 x 5.5	3.25	2.750 w/ 5/8 x 7/32	68.5 w/ 20 x 6
SMB-2	3.5	2.875 w/ 3/4 x 1/4	73.0 w/ 20 x 6	3.875	3.250 w/ 3/4 x 1/4	82.0 w/ 22 x 7
SMB-3	5	4.250 w/ 1.0 x 3/8	108.0 w/ 28 x 8	5.75	4.750 w/ 1 1/4 x 7/16	120.7 w/ 32 x 9
SMB-4	5	4.500 w/ 1.0 x 1/2	114.3 w/ 32 x 9	6.75	6.000 w/ 1 1/2 x 1/2	152.4 w/ 40 x 11
SMB-5	6.25	5.250 w/ 1 1/4 x 7/16	133.4 w/ 36 x 10	8	7.000 w/ 1 3/4 x 5/8	177.8 w/ 45 x 12.5
SMB-5T	N/A	6.000 w/ 1 1/2 x 1/2	152.4 w/ 40 x 11	N/A	8.000 w/ 2.0 x 3/4	203.2 w/ 50 x 14
SMB-5XT	N/A	N/A		6.25	10.000 w/ 1 1/4 x 5/8	254.0 w/ 56 x 16

Available AC motors (ft-lb) and corresponding actuator weights*

Model	Available motor		Weights**		+Adder for SB		+Adder for SBD	
	4P	2P	lb	kg	lb	kg	lb	kg
SMB-000	2, 5	2	145	66	N/A	N/A	N/A	N/A
SMB-00	10, 15, 25	10, 25	250	113	30	14	75	34
SMB-0	10, 15, 25, 40	10, 15, 25	395	179	65	29	100	45
SMB-1	25, 40, 60	25, 40, 60	575	261	130	59	245	111
SMB-2	40, 60, 80	40, 60, 80	755	342	270	122	325	147
SMB-3	60, 80, 100, 150	60, 80, 100, 150	1325	601	300	136	420	191
SMB-4	60, 80, 100, 150, 200 (-4T), 250, 300	100, 150, 200, 250	2115	959	470	213	960	435
SMB-5 & 5T	150, 200, 250, 300, 350, 400	150, 200, 250, 300, 350, 400	3835	1740	N/A	N/A	N/A	N/A
SMB-5XT	150, 200, 250, 300, 350, 400	150, 200, 250, 300, 350, 400	6075	2756	N/A	N/A	N/A	N/A

* Weights are for the largest motor for each size, with standard diameter handwheel, 4-train geared limit switch, iron control compartment cover, and no integral reversing controls package.

SB/SBD Performance Ratings

Commercial service ratings

Ratio range		Max torque rating		Max thrust rating	
		ft-lb	N m	lb	kN
SB-00	all	260	353	14,000	62
SB-0	all	700	949	24,000	107
SB-1	all	1100	1491	45,000	200
SB-2	all	1950	2644	70,000	311
SB-3	all	4200	5694	140,000	623
SB-4	all	8300	11,253	250,000	1112

Maximum stem capacity (inches)

	SB	SBD
SB-00	1.25	1.25
SB-0	2.38	2.25
SB-1	2.63	2.50
SB-2	3.50	3.50
SB-3	4.00	3.50
SB-4	5.00	5.00

Available motors (ft-lb)

	4P	2P
SB-00	10, 15, 25	10, 25
SB-0	10, 15, 25, 40	10, 15, 25
SB-1	25, 40, 60	25, 40, 60
SB-2	40, 60, 80	40, 60, 80
SB-3	60, 80, 100, 150	60, 80, 100, 150
SB-4	100, 150, 200, 250, 300	100, 150, 200, 250

Mounting base and drive sleeves (all dimensions in inches)

	Pilot diameter	Pilot length	Mounting holes	# of holes and distance BC	Mounting base dia.
SMB-000	2.312	0.125	5/16-18 UNC x .63	(4) @90°, 3.250	4.88
SMB-00	3.750	0.125	5/8-11 UNC x 1.13	(4) @90°, 5.500	7
SMB-0	5.000	0.188	3/4-10 UNC x 1.00	(4) @90°, 6.500	8.25
SMB-1	6.000	0.188	5/8-11 UNC x 1.00	(8) @45°, 10.000	11.38
SMB-2	7.000	0.188	3/4-10 UNC x 1.13	(8) @45°, 11.75	13.5
SMB-3	8.500	0.188	7/8-9 UNC x 1.75	(8) @45°, 14.000	16
SMB-4	9.000	0.375	1 1/4-7 UNC x 2.00	(8) @45°, 16.000	18.75
SMB-5	13.000	0.438	1 1/2-6 UNC x 3.00	(12) @30°, 18.000	21
SMB-5T	18.001 C'bore	2.00 C'bore depth	1-8 UNC x 2.00	(16) @22.5°, 23.500	25.5
SMB-5XT	17.000 C'bore	0.375 C'bore depth	1 1/16 dia. through holes	(16) @22.5°, 20.500	25.5

	Pilot diameter (mm)	Pilot length (mm)	Mounting holes (in.)	# of holes & distance BC (mm)	Mounting base dia. (mm)
SMB-000	58.72	3.18	5/16-18 UNC x .63	(4) @90°, 82.55	123.95
SMB-00	95.25	3.18	5/8-11 UNC x 1.13	(4) @90°, 139.7	177.8
SMB-0	127.0	4.78	3/4-10 UNC x 1.00	(4) @90°, 165.1	209.55
SMB-1	152.4	4.78	5/8-11 UNC x 1.00	(8) @45°, 254.0	289.05
SMB-2	177.8	4.78	3/4-10 UNC x 1.13	(8) @45°, 298.45	342.9
SMB-3	215.9	4.78	7/8-9 UNC x 1.75	(8) @45°, 355.6	406.4
SMB-4	228.6	9.53	1 1/4-7 UNC x 2.00	(8) @45°, 406.4	476.25
SMB-5	330.2	11.13	1 1/2-6 UNC x 3.00	(12) @30°, 457.2	533.4
SMB-5T	457.4 C'bore	50.8 C'bore depth	1-8 UNC x 2.00	(16) @22.5°, 596.9	647.7
SMB-5XT	431.9 C'bore	9.53 C'bore depth	1 1/16 dia. through holes	(16) @22.5°, 520.7	647.7

Dimensional drawings and wiring diagrams can be accessed at:
<https://www.flowserve.com/en/limitorque/limitorque-electric-actuators>

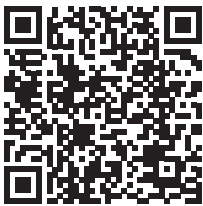

Installation, operation, and maintenance instructions are found in the SMB IOM, LMENIM1401.

SMB features and technical data are found in the SMB product brochure, LMENBR1400



Flowserve Corporation
Flow Control

United States

Flowserve Limitorque
5114 Woodall Road
P.O. Box 11318
Lynchburg, VA 24506-1318
Phone: 434-528-4400
Facsimile: 434-845-9736

Italy

Flowserve Limitorque
Via Rio Vallone 17
20883 Mezzago (MB), Italy
Phone: +39-039-62060-1
Facsimile: +39-039-62060-213

Japan

Limitorque – Nippon Gear Co., Ltd.
NOF Bldg. 9th Floor
1-11-11, Kita-Saiwai, Nishi-Ku
Yokohama (220-0004)
Japan
Phone: 81-45-326-2065
Facsimile: 81-45-320-5962

Singapore

Flowserve Limitorque
12, Tuas Avenue 20
Singapore 638824
Phone: 65-6868-4628
Facsimile: 65-6862-4940

China

Limitorque Beijing, Pte., Ltd.
RM A1/A2
22/F, East Area, Hanwei Plaza
No. 7 Guanghua Road, Chaoyang District
Beijing 100004, Peoples Republic of China
Phone: 86-10-5921-0606
Facsimile: 86-10-6561-2702

India

Flowserve Limitorque
Office A, 7th Floor, Plot No. 32 A&B
Ambit IT Park, Ambit IT Park Road
Ambattur Industrial Estate,
Chennai - 600058
Phone: 91-44-2432-8755
91-44-2432-4801
Facsimile: 91-44-2432-8754

FCD LMENBR1400-06-AQ Printed in USA. 02/18. © 2015 Flowserve Corporation

To find your local Flowserve representative:

visit www.limitorque.com or call 1 434 528 4400

While the information contained in this literature is believed to be accurate, the content is provided for informative purposes only. Nothing contained herein is to be considered certified data with respect to this product. Because Flowserve is continually improving and upgrading its product design, the specifications and information contained herein are subject to change without notice. Should any question arise concerning these provisions, please contact Flowserve Corporation at any one of its worldwide operations or offices.