



Modular Automation System

A systematic means for modernizing existing delayed coker units



Experience In Motion

Continuously advancing safety, availability and profitability



Through its Worthington®, Pacific® and IDP® heritage brands, Flowserve has played a leading role in hydraulic decoking since the technology's inception more than three-quarters of a century ago. From the original combination cutting tools and jet pumps to today's state-of-the-art remotely operated and fully automated systems, Flowserve is the overwhelming supplier of choice for hydraulic decoking systems, with more than 200 installations globally, comprising over 90% of the world's units. Process licensors, EPC firms and DCU operators alike turn to Flowserve for its proven applications expertise and problem-solving capabilities.



Flowserve Worthington supplies the cutting tools, swivel joints, control valves and jet pumps for the world's first hydraulic decoking installation at Shell Oil's Wood River, Illinois, (USA) refinery.

1938

1940

Flowserve Pacific supplies hydraulic decoking jet pumps at Standard Oil's El Dorado, Kansas, (USA) refinery.

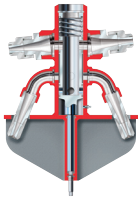

Flowserve Pacific introduces the "combo" design — an axially shifted combination tool incorporating both boring and cutting nozzles within a single body.

1979

1981

Flowserve Pacific introduces the decoking control valve that ensures the jet pump is never in a blocked condition.



Flowserve installs first hydraulic motor-driven winch and rotary joint combination.

1994

1998

The need for higher pressure systems with increased efficiency results in the rotary shifted combination tool.

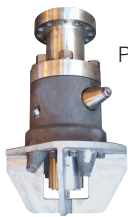

Patented AutoShift™ rotary actuated and remotely shifted combination tool opens the door to decoking system automation.

2003

2004

Flowserve equips the first remotely operated cutting system. Vibration drum monitoring is introduced.

Flowserve installs electric motor-driven winch and rotary joint with VFD control.

2008

2010

Vibration drum monitoring is updated with improved operator feedback.



Flowserve designs and ships the first fully automated coke cutting system with coker-specific designs for audio and video monitoring.

2011

2013

Flowserve releases advanced decoking control valve to replace the Pacific decoking control valve. The new valve improves mean time between repair (MTBR) and field maintainability.

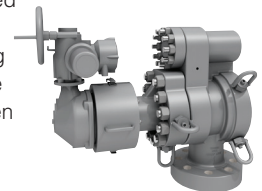

Modular technology that makes decoking system automation more accessible

Implementing the latest technology in the most efficient and cost-effective way is the goal of many decoking maintenance managers. The removal of operators from the cutting deck requires many of the latest technological advances introduced since 2010.

The introduction of drum monitoring through vibration and the AutoShift tool, along with significant advancements in associated equipment design, now make remote operation possible. The addition of modern instrumentation, controls and software technology can achieve system automation for reduced cutting times with greater throughput, maximum reliability and lowest total cost of ownership.

Flowserve has now modularized this approach to allow for a more systematic and achievable means to modernize existing hydraulic decoking systems.

The modular approach entails:

- Upgrading system instrumentation
- Upgrading pneumatic winches and rotary joints systems to a minimum of electric over air actuation
- Reprogramming the PLC or upgrading the control system to PLC to incorporate new instrumentation modules

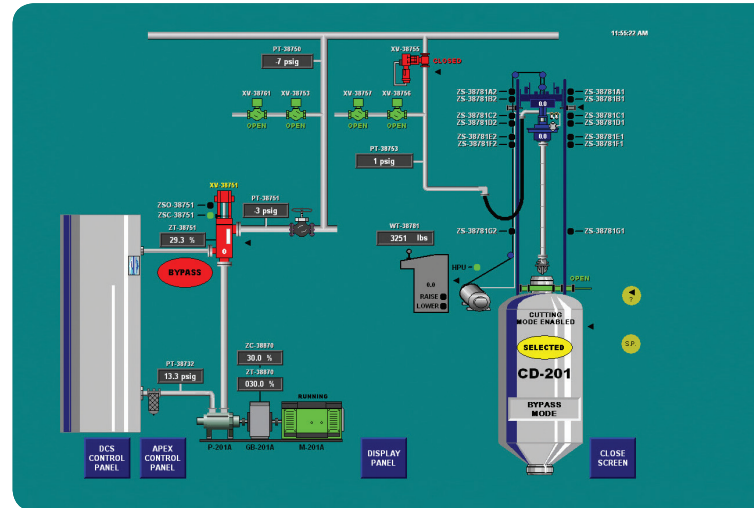

Flowserve has pioneered numerous significant advancements in hydraulic decoking, transforming it into an increasingly safe, efficient and automated process.

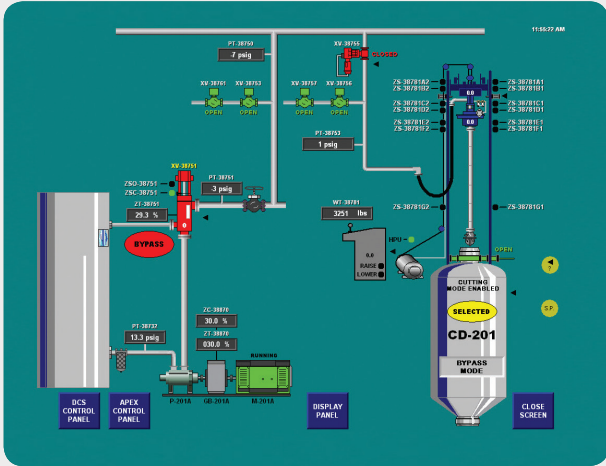

Driven by data

The Flowserve Modular Automation System (MAS) enables incremental system updates that provide operators with the information needed to operate the decoking system from a remote location. It can also provide input to an integrated PLC system, allowing for automated operation of the decoking system.

With technology proven in multiple installations, the MAS is expandable. Future upgrades will support fully automated remote operations. The MAS is rated for UL and ATEX requirements.

MAS capabilities

		AUTOMATION MODULES							
Monitoring System	Instrumentation	Qty. (per pair of drums)	AM1/Base	AM2/AI Vibration	AM3/AI Audio	AM3/AO Audio	AM4/AI Tension	AM5/DI Counter	AM6/AI Open
Base Unit	MAS Panel	1	•						
	HMI (Optional)	2	•						
Vibration Monitoring	*Vibration Probes and Junction Boxes	8/10		•					
Audio Monitoring	Vibration Probes	1			•				
	Speaker or Headphone	1				•			
Tensiometer	Deck-mounted Tensiometers (Option 1)	2					•		
	Running Line Tensiometers (Option 2)	2					•	•	
Tool Position/Feed Velocity	Proximity Probes to be Mounted on Crown Block	4						•	
Rotary Joint Rotation Speed	Proximity Probes to be Mounted on Rotary Joint	2						•	
Rotary Joint Seal Failure	Wireless Pressure Transmitter to be Mounted on Rotary Joint	1							•

* Four or five probes per drum, depending on drum height

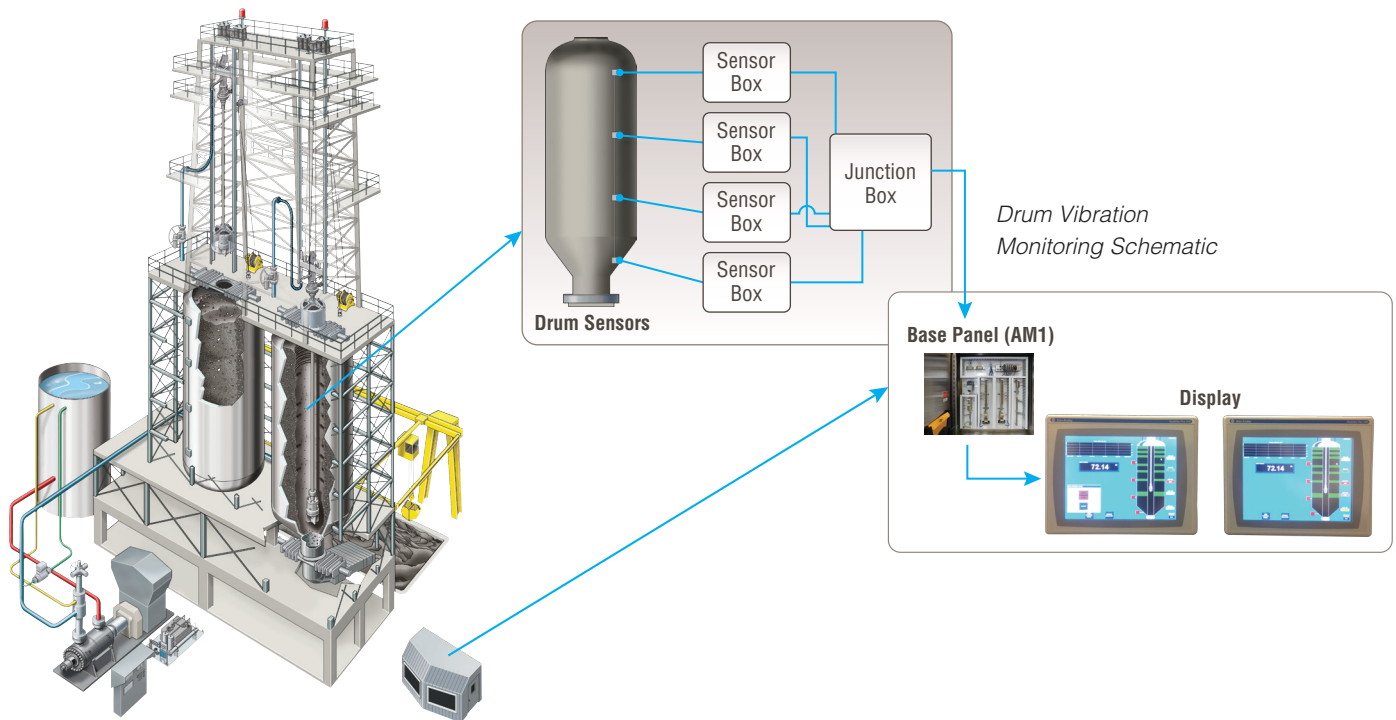

Base panel

The primary component of the MAS is the base panel, with optional human-machine interface (HMI). The panel houses an embedded real-time controller with reconfigurable field-programmable gate array (FPGA), power supply, Ethernet switch, and pre-marked terminals for each of the available standard automation features via Modbus TCP/IP.

The controller is sized to accommodate eight modules taking field instrument readings. Data is processed to display on a stand-alone HMI in modular upgrade situations. Data may also be transferred to the PLC for remote or automated cutting.

As different features are purchased, modules and their associated instrumentation are supplied for mounting in the base panel and the field, respectively.

HMIs are available for existing systems for direct-to-operator visuals without the need of PLC support.

Drum monitoring systems

Vibration and acoustic drum monitoring modules are available to add to the base panel. These modules provide feedback that informs operators of cutting progress, while enabling them to visualize and hear cutting deck, chute and pit activities.

Vibration

The drum vibration module is offered with four or five sensors, depending on the height of the drum. Feedback is displayed on the HMI panel (either existing or purchased separately).

Audio

Feedback on cutting progress and activities is enhanced by acoustic systems designed to help the operator determine the progress of coke removal. As coke is cut from the drum, the sound of the impinging water changes, allowing the operator to “hear” when a section of the drum is clean.

The audio module requires a single vibration probe to be mounted to each drum if purchased alone. The audio module can also be paired with the optional vibration module for higher-resolution audio.



High-temperature accelerometers monitor vibrations on the coke drum wall. The resulting signals provide the operator with information regarding drum cleanliness status.

Flowserve Modular Automation System takes remote cutting to its ultimate destination: A new standard for decoking system safety, availability and efficiency.

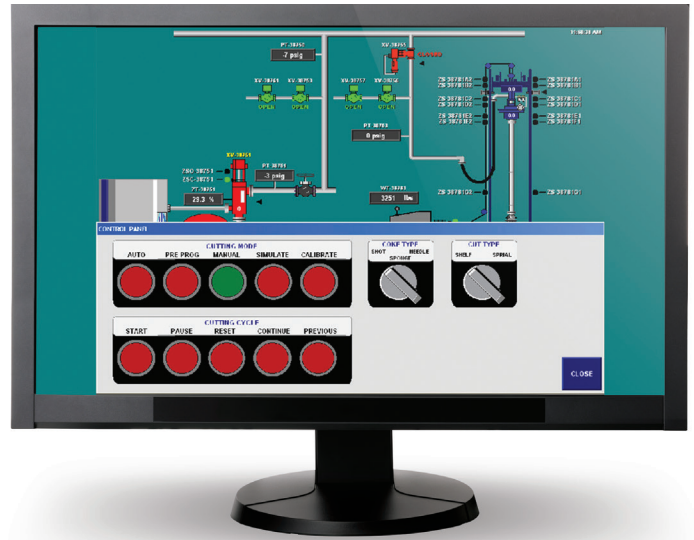

Control measures

Tension measurement

Tension measurement is important to automation, as it provides a secondary indication of the cutting or boring tool condition. There are two options available for tension measurement: deck-mounted and running line tensiometers. Located at the winch wire rope termination location, the deck-mounted tensionmeter consists of a compression load cell and is able to measure tension in the winch wire rope. Running line tensiometers are used when rewiring of the winch is not planned. They can be located anywhere on the line between the winch and the guide block, provided there is sufficient support.

Position and speed measurement

During automated operation, it is important to know where the cutting tool is located within the drum. On most existing systems, proximity probes on the crown block indicate feed length into the drum.

If not already tied into a PLC system, the MAS uses these same probes to identify the position and speed at which the tool is moving inside the drum. A running line tensiometer can also measure position and speed.

Rotary joint condition

The rotary joint rotation speed impacts the speed at which a drum can be safely cut or bored. A wired or wireless sensor on the rotary joint provides this important feedback from the field.

In addition, Flowserve offers wireless sensors to detect cartridge seal leaks. These sensors provide advance warning of a primary seal leak so as to allow sufficient time (three to six weeks) for replacement parts to be ordered and delivered.

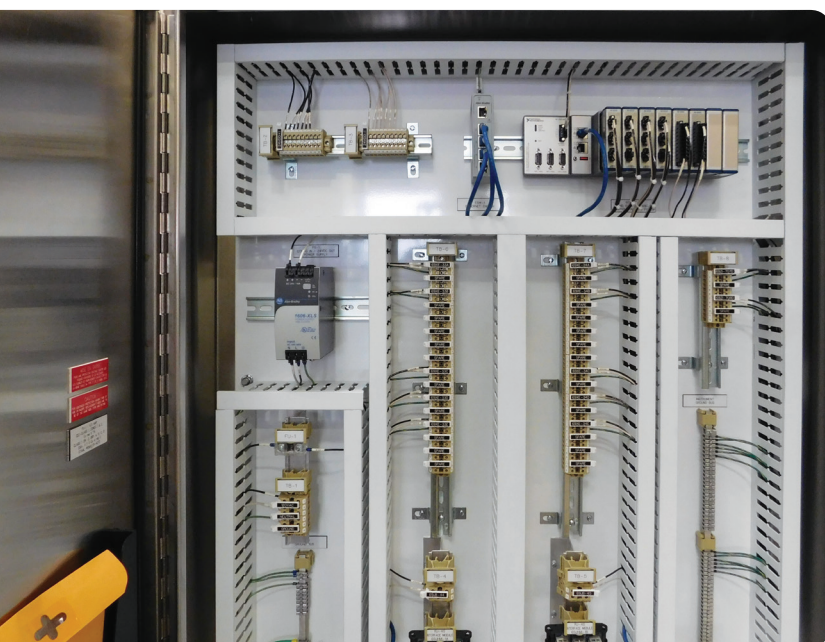

Pre-engineered and defined scope provide high value to customers.

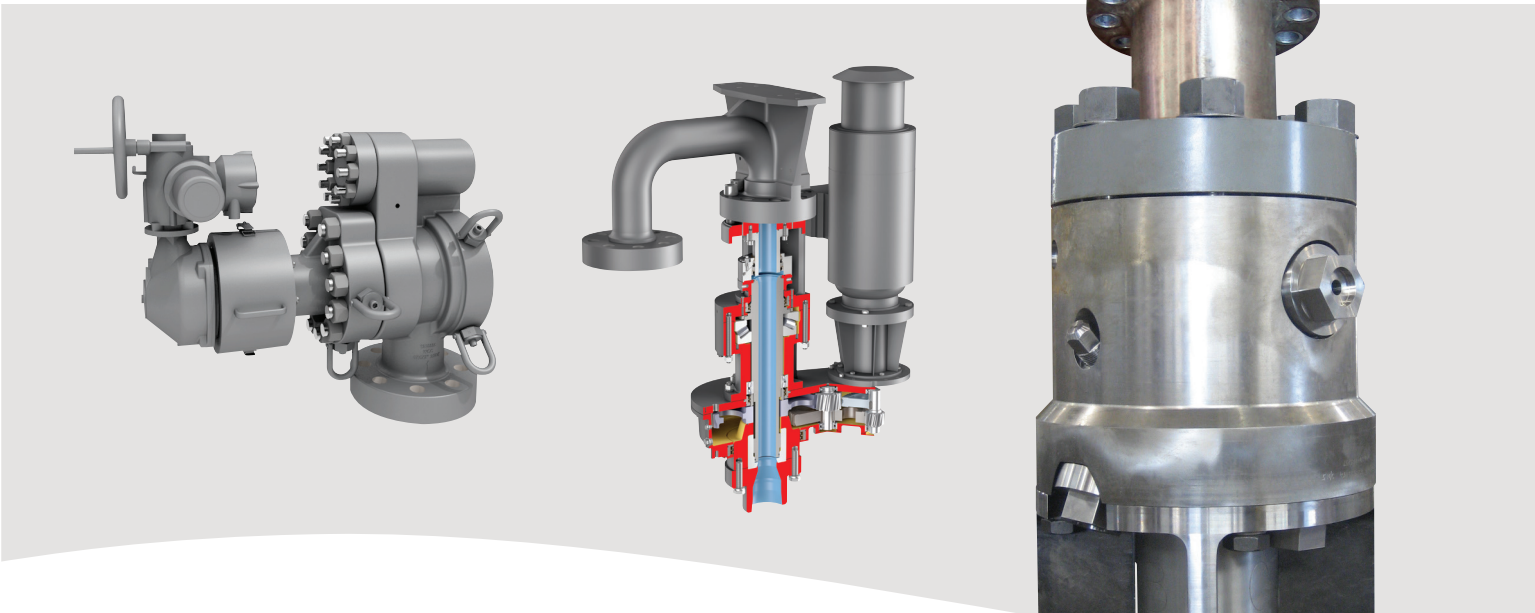

Coke cutting system upgrades and services

Most Flowserve decoking units installed after 2005 can be upgraded easily to remotely operated or automated systems by adding drum monitoring instrumentation and equipment. Older systems require a customized and comprehensive review to identify the most cost-effective safety and performance upgrades.

Regardless of OEM, Flowserve offers replacement of vintage decoking equipment with all-new or significantly redesigned models, including:

- Cutting tools
- Decoking control valves
- Rotary joints
- Jet pumps
- Control systems

Upgrade experts

A global network of Flowserve decoking specialists will help evaluate and specify the equipment and components required to upgrade an existing hydraulic cutting operation into the most cost-effective, state-of-the-art remotely operated or automated system possible.

With improved safety and efficiency as the goals, the Flowserve decoking specialists will:

- Assess each component of the system for proper functionality
- Audit the control system for hardware and software technology improvements
- Provide recommendations and action steps for system conversion

Field service and technical support

Flowserve customer service technicians are on call 24 hours a day, seven days a week to respond to scheduled or unscheduled outages, construction, installation and start-up service needs. Technicians are specifically trained to evaluate and troubleshoot problems with decoking systems and equipment. Backed by Flowserve design and engineering groups, technicians have access to manufacturing drawings, bills of material and performance data so they can develop practical and reliable solutions to decoking problems.



Automation removes the need for hand-held measurement.



Flowserve Corporation
5215 North O'Connor Blvd.
Suite 2300
Irving, Texas 75039-5421 USA
Telephone: +1 937 890 5839

PS-90-24 (E) August 2017
© 2017 Flowserve Corporation

Flowserve Corporation has established industry leadership in the design and manufacture of its products. When properly selected, this Flowserve product is designed to perform its intended function safely during its useful life. However, the purchaser or user of Flowserve products should be aware that Flowserve products might be used in numerous applications under a wide variety of industrial service conditions. Although Flowserve can provide general guidelines, it cannot provide specific data and warnings for all possible applications. The purchaser/user must therefore assume the ultimate responsibility for the proper sizing and selection, installation, operation, and maintenance of Flowserve products. The purchaser/user should read and understand the Installation Instructions included with the product, and train its employees and contractors in the safe use of Flowserve products in connection with the specific application.

While the information and specifications contained in this literature are believed to be accurate, they are supplied for informative purposes only and should not be considered certified or as a guarantee of satisfactory results by reliance thereon. Nothing contained herein is to be construed as a warranty or guarantee, express or implied, regarding any matter with respect to this product. Because Flowserve is continually improving and upgrading its product design, the specifications, dimensions and information contained herein are subject to change without notice. Should any question arise concerning these provisions, the purchaser/user should contact Flowserve Corporation at any one of its worldwide operations or offices.